

**Intergovernmental
Oceanographic
Commission**

**Scientific
Committee on
Oceanic Research**

Manual and Guides **29**



**PROTOCOLS FOR THE JOINT GLOBAL
OCEAN FLUX STUDY (JGOFS)
CORE MEASUREMENTS**



INTERGOVERNMENTAL OCEANOGRAPHIC COMMISSION
COMMISSION OCÉANOGRAPHIQUE INTERGOUVERNEMENTALE
COMISIÓN OCEANOGRÁFICA INTERGUBERNAMENTAL
МЕЖПРАВИТЕЛЬСТВЕННАЯ ОКЕАНОГРАФИЧЕСКАЯ КОМИССИЯ
اللجنة الدولية الحكومية لعلوم المحيطات
政府间海洋学委员会

UNESCO - 1, rue Miollis - 75732 Paris cedex 15
cable address: UNESCO Paris - telex: 204461 Paris-fax: (33.1) 40 56 93 16 - contact phone: (33.1)

from:

Your reference:

In reply refer to:

IOC MANUALS AND GUIDES No.29

"PROTOCOLS FOR THE JOINT GLOBAL OCEAN FLUX STUDY (JGOFS) CORE MEASUREMENTS"

This manual describes the protocols approved by the international Scientific Steering Committee for the Joint Global Ocean Flux Study (JGOFS) for most of the 20 JGOFS Core Measurements. However, the methods for the analysis of various parameters of the seawater CO₂ system are described in a separate handbook.

In order to have a complete set of the JGOFS measurement protocols, you should request a copy of the "Handbook of Methods for the Analysis of the Various Parameters of the Carbon Dioxide System in Seawater" version 2, A. G. Dickson and C. Goyet, eds. ORNL/CDIAC-74. This is available from:

Executive Director
Scientific Committee on Oceanic Research
Department of Earth and Planetary Sciences
The Johns Hopkins University
Baltimore, MD 21218, USA

Tel: 410-516-4070
Fax: 410-516-4019
e-mail: scor@jhuvms.hcf.jhu.edu

Chairman

Dr. Manuel M. Murillo
Director
Asuntos Internacionales y Cooperación Exterior
Universidad de Costa Rica
San José (Costa Rica)

Secretary

Dr. Gunnar Kullenberg
Intergovernmental Oceanographic Commission
UNESCO
1, rue Miollis
75732 Paris Cedex 15 (France)

Vice-Chairmen

Mr. Geoffrey L. Holland
Director-General
Physical & Chemical Sciences Directorate
Dept. of Fisheries & Oceans
12th Floor, 200 Kent St.
Ottawa, Ont. K1A 0E6 (Canada)

Dr. Hussein Kamel Badawi
President
National Institute of Oceanography & Fisheries
Ministry of Scientific Research
101, Kasr El-Ainy Street, Cairo (Egypt)

Dr. Alexandre P. Metalnikov
Counsellor
Russian State Committee for Hydrometeorology
12, Pavlik Morozova Street
Moscow 123376 (Russian Federation)

Prof. Dr. Jilan Su
Second Institute of Oceanography
State Oceanic Administration
P.O. Box 1207
Hangzhou, Zhejiang 310012 (China)

IOC Manuals and Guides

No.	Title
1 rev.2	Guide to IGOSS Data Archives and Exchange (BATHY and TESAC). 1993. 27 pp. (English, French, Spanish, Russian)
2	International Catalogue of Ocean Data Stations. 1976. (<i>out of stock</i>)
3 rev.2	Guide to Operational Procedures for the Collection and Exchange of IGOSS Data. Second Revised Edition, 1988. 68 pp. (English, French, Spanish, Russian)
4	Guide to Oceanographic and Marine Meteorological Instruments and Observing Practices. 1975. 54 pp. (English)
5	Guide to Establishing a National Oceanographic Data Centre. 1975. (<i>out of stock</i>)
6 rev.	Wave Reporting Procedures for Tide Observers in the Tsunami Warning System. 1988. 30 pp. (English)
7	Guide to Operational Procedures for the IGOSS Pilot Project on Marine Pollution (Petroleum) Monitoring. 1976. 50 pp. (French, Spanish)
8	(<i>superseded by IOC Manuals and Guides no. 16</i>)
9 rev.	Manual on International Oceanographic Data Exchange. (Fifth Edition). 1991. 82 pp. (French, Spanish, Russian)
9 Annex I	(<i>superseded by IOC Manuals and Guides no. 17</i>)
9 Annex II	Guide for Responsible National Oceanographic Data Centres. 1982. 29 pp. English, French, Spanish, Russian)
10	(<i>superseded by IOC Manuals and Guides no. 16</i>)
11	The Determination of Petroleum Hydrocarbons in Sediments. 1982. 38 pp. (French, Spanish, Russian)
12	Chemical Methods for Use in Marine Environment Monitoring. 1983. 53 pp. (English)
13	Manual for Monitoring Oil and Dissolved/Dispersed Petroleum Hydrocarbons in Marine Waters and on Beaches. 1984. 35 pp. (English, French, Spanish, Russian)
14	Manual on Sea-Level Measurements and Interpretation. 1985. 83 pp. (English, French, Spanish, Russian)
15	Operational Procedures for Sampling the Sea-Surface Microlayer. 1985. 15 pp. (English)
16	Marine Environmental Data Information Referral Catalogue. Third Edition. 1993. 157 pp. (Composite English/French/Spanish/Russian)

(*continued on back inside cover*)

- 17 GF3 : A General Formatting System for Geo-referenced Data**
- Vol. 1 : Introductory Guide to the GF3 Formatting System. 1993. 35 pp.**
(English, French, Spanish, Russian)
- Vol. 2 : Technical Description of the GF3 Format and Code Tables. 1987. 111 pp.**
(English, French, Spanish, Russian)
- Vol. 4 : User Guide to the GF3-Proc Software. 1989. 23 pp.**
(English, French, Spanish, Russian)
- Vol. 5 : Reference Manual for the GF3-Proc Software 1992. 67 pp.**
(English, French, Spanish, Russian)
- Vol. 6 : Quick Reference Sheets for GF3 and GF3-Proc 1989. 22 pp.**
(English, French, Spanish, Russian)
- 18 User Guide for the Exchange of Measured Wave Data. 1987. 81 pp.**
(English, French, Spanish, Russian)
- 19 Guide to IGOSS Specialized Oceanographic Centres (SOCs). 1988. 17 pp.**
(English, French, Spanish, Russian)
- 20 Guide to Drifting Data Buoys. 1988. 71 pp. (English, French, Spanish, Russian)**
- 21 *(superseded by IOC Manuals and Guides no. 25)***
- 22 GTSPP Real-time Quality Control Manual. 1990. 122 pp. (English)**
- 23 Marine Information Centre Development : An Introductory Manual. 1991. 32 pp.**
(English, French, Spanish, Russian)
- 24 Guide to Satellite Remote Sensing of the Marine Environment. 1992. 178 pp. (English)**
- 25 Standard and Reference Materials for Marine Science. Revised Edition, 1993. 577 pp.**
(English)
- 26 Manual of Quality Control Procedures for Validation of Oceanographic Data. 1993.**
436 pp. (English)
- 27 Chlorinated Biphenyls in Open Ocean Waters : Sampling, Extraction, Clean-up and**
Instrumental Determination. 1993. 36 pp. (English)
- 28 Nutrient Analysis in Tropical Marine Waters. 1993. 24 pp. (English)**
- 29 Protocols for the Joint Global Ocean Flux Study (JGOFS) Core Measurements. 1994.**
178 pp. (English)

Preface	1
Chapter 1 Introduction by Dr. A.H. Knap	2
Chapter 2. Shipboard Sampling Procedures	
1.0 Introduction	3
2.0 Hydrocasts	3
3.0 Water Sampling	4
4.0 Primary Production	4
5.0 Sediment Trap Deployment and Recovery	4
6.0 Shipboard Sample Processing	5
Chapter 3 CTD and Related Measurements	
1.0 Scope and field of application	5
2.0 Apparatus	5
3.0 Data Collection	7
4.0 Data Processing	8
5.0 References	11
Chapter 4. Quality Evaluation and Intercalibration	
1.0 Introduction	13
2.0 Definition	15
3.0 Principle	15
4.0 Apparatus	15
5.0 Reagents	15
6.0 Sampling	16
7.0 Procedures	16
8.0 Calculation and expression of results	16
9.0 Quality assurance	17
10.0 References	17
Chapter 5. Salinity Determination	15
1.0 Scope and field of application	15
2.0 Definition	15
3.0 Principle of Analysis	15
4.0 Apparatus	15
5.0 Reagents	15
6.0 Sampling	16
7.0 Procedures	16
8.0 Calculation and expression of results	16
9.0 Quality assurance	17
10.0 References	17
Chapter 6. Determination of Dissolved Oxygen by the Winkler Procedure	
1.0 Scope and field of application	18
2.0 Definition	18
3.0 Principle of Analysis	18
4.0 Apparatus	19
5.0 Reagents	20
6.0 Sampling	21
7.0 Titration Procedures	22
8.0 Calculation and expression of results	23
9.0 Quality assurance	24
10.0 References	25
Chapter 7. The Determination of Total Inorganic Carbon by the Coulometric Procedure	
1.0 Scope and field of application	26

2.0	Definition	26
3.0	Principle of Analysis	26
4.0	Apparatus	27
5.0	Reagents	28
6.0	Sampling	29
7.0	Procedures	29
8.0	Calculation and expression of results	31
9.0	Quality assurance	31
10.0	References	32

Chapter 8. The Determination of Nitrite, Nitrate + Nitrite, Orthophosphate and Reactive Silicate in Seawater using continuous Flow Analysis

1.0	Scope and field of application	33
2.0	Definition	33
3.0	Principle of Analysis	34
4.0	Apparatus	35
5.0	Reagents	40
6.0	Sampling	42
7.0	Procedures and Standardization:	46
8.0	Analytical Methods	52
9.0	Calculations.	66
10.0	Quality Assurance:	72
11.0	References	74

Chapter 9. The Determination of Nitrate in Sea Water

1.0	Scope and field of application	76
2.0	Definition	76
3.0	Principle of Analysis	76
4.0	Apparatus	77
5.0	Reagents	77
6.0	Sampling	77
7.0	Procedures	77
8.0	Calculation and expression of results	79
9.0	Notes	79
10.0	References	80

Chapter 10. The Determination of Nitrite in Sea Water

1.0	Scope and field of application	81
2.0	Definition	81
3.0	Principle of Analysis	81
4.0	Apparatus	81
5.0	Reagents	81
6.0	Sampling	81
7.0	Procedures	82
8.0	Calculation and expression of results	83
9.0	References	83

Chapter 11 The Determination of Phosphorus in Sea Water

1.0	Scope and field of application	83
2.0	Definition	83
3.0	Principle of Analysis	84
4.0	Apparatus	84
5.0	Reagents	84
6.0	Sampling	84
7.0	Procedures	85
8.0	Calculation and expression of results	86
9.0	References	86

Chapter 12. The Determination of Reactive Silicate in Sea Water		
1.0	Scope and field of application	87
2.0	Definition	87
3.0	Principle of Analysis	87
4.0	Apparatus	87
5.0	Reagents	87
6.0	Sampling	88
7.0	Procedures	88
8.0	Calculation and expression of results	89
9.0	Notes	90
10.0	References	90
Chapter 13. Measurement of Algal Chlorophylls and Carotenoids by HPLC		
1.0	Scope and field of application	91
2.0	Definition	91
3.0	Principle of Analysis	91
4.0	Apparatus and Reagents	92
5.0	Eluants	92
6.0	Sample Collection and Storage	93
7.0	Procedure	93
8.0	Calculation and expression of results	94
9.0	References	95
Chapter 14. Measurement of Chlorophyll a and Phaeopigments by Fluorometric Analysis		
1.0	Scope and field of application	97
2.0	Definition	97
3.0	Principle of Analysis	97
4.0	Apparatus	97
5.0	Reagents	98
6.0	Sample Collection and Storage	98
7.0	Procedure	98
8.0	Calculation and expression of results	100
9.0	References	100
Chapter 15. Determination of Particulate Organic Carbon and Particulate Nitrogen		
1.0	Scope and field of application	101
2.0	Definition	101
3.0	Principle of Analysis	101
4.0	Apparatus	101
5.0	Reagents	101
6.0	Sampling	102
7.0	Procedures	102
8.0	Calculation and expression of results	103
9.0	References	103
Chapter 16. Determination of Dissolved Organic Carbon by a High Temperature Combustion/Direct Injection Technique		
1.0	Scope and field of application	104
2.0	Definition	104
3.0	Principle of analysis	104
4.0	Apparatus	105
5.0	Reagents	105
6.0	Sampling	106
7.0	Procedures	108

8.0	Calculation and Expression of Results	110
9.0	Quality control/quality assessment	113
10.0	Notes	114
11.0	Intercomparison	116
12.0	References	117
Chapter 17 Determination of New Production by ^{15}N		
1.0	Scope and field of application	119
2.0	Definition	119
3.0	Principle of Analysis	119
4.0	Apparatus	119
5.0	Reagents	120
6.0	Sampling	120
7.0	Procedures	120
8.0	Calculation and Expression of Results	121
9.0	Quality Control	122
10.0	Intercomparison	122
11.0	Parameters	122
12.0	References	123
Chapter 18. Determination of Bacterioplankton Abundance		
1.0	Scope and field of application	125
2.0	Definition	125
3.0	Principle of Analysis	125
4.0	Apparatus	125
5.0	Reagents	125
6.0	Sampling	126
7.0	Procedures	126
8.0	Calculation and expression of results:	127
9.0	Quality control	127
10.0	References	127
Chapter 19. Primary Production by ^{14}C		
1.0	Scope and field of application	128
2.0	Definition	128
3.0	Principle of Analysis	128
4.0	Apparatus	128
5.0	Reagents and Supplies	129
6.0	Sampling	131
7.0	Procedures	132
8.0	Calculation and expression of results	133
9.0	Quality Control	133
10.0	Notes	134
11.0	References	134
Chapter 20. Determination of Bacterial Production using Methyl- tritiated Thymidine		
1.0	Scope and field of application	135
2.0	Definition	135
3.0	Principle of analysis	135
4.0	Apparatus	135
5.0	Reagents	136
6.0	Sampling and incubation	137
7.0	Procedures	137
8.0	Calculation and expression of results	138
9.0	Quality Control	138
10.0	Interpretation of results	139
11.0	References	139

Chapter 21. Determination of Bacterial Production using Tritiated**Leucine**

1.0	Scope and field of application	141
2.0	Definition	141
3.0	Principle of analysis	141
4.0	Apparatus	141
5.0	Reagents.	142
6.0	Sampling and incubation.	142
7.0	Procedures.	143
8.0	Calculation and expression of results.	143
9.0	Other Remarks	144
10.0	References	145

Chapter 22. Microzooplankton Biomass

1.0	Scope and field of application	147
2.0	Definition	147
3.0	Principle	147
4.0	Apparatus	147
5.0	Reagents	147
6.0	Sampling	148
7.0	Procedures	148
8.0	Calculation and expression of results	149
9.0	Quality control and assessment	150
10.0	Notes	150
11.0	Intercomparison	151
12.0	References & JGOFS papers published using these techniques	151

Chapter 23. Microzooplankton Herbivory

1.0	Scope and field of application	152
2.0	Definition	152
3.0	Principle	152
4.0	Apparatus	152
5.0	Reagents	153
6.0	Sampling	153
7.0	Procedures	153
8.0	Calculation and expression of results.	155
9.0	Quality control and assessment	155
10.0	Notes	155
11.0	Intercomparison	155
12.0	References & JGOFS papers published using these techniques	155

Chapter 24. JGOFS Sediment Trap Methods

		157
1.0	Scope and field of application	157
2.0	Scope and Field of Application	157
3.0	Definition	157
4.0	Principle of Analysis	158
5.0	Apparatus	158
6.0	Reagents	158
7.0	Sampling	158
8.0	Post-collection Procedures	160
9.0	Calculation and Expression of Results	162
10.0	Quality Control/Quality Assessment	162
11.0	Intercomparison	163
12.0	Notes	163
13.0	References	163

Chapter 25. Trap-Collected Particle Flux with Surface-Tethered

	Traps	
1.0	Scope and field of application	164
2.0	Definition	164
3.0	Principle of Analysis	164
4.0	Apparatus	165
5.0	Reagents	165
6.0	Sampling	166
7.0	Sample Processing Procedures	167
8.0	Calculation and expression of results.	168
9.0	Quality Control and Assessment	168
10.0	References and Related Literature	169

Preface

The Joint Global Ocean Flux Study relies on a variety of techniques and measurement strategies to characterize the biogeochemical state of the ocean, and to gain a better mechanistic understanding required for predictive capability. Early in the program, a list of Core Measurements was defined as the minimum set of properties and variables JGOFS needed to achieve these goals. Even at the time of the North Atlantic Bloom Experiment (NABE), in which just a few nations and a relatively small number of laboratories contributed most of the measurements, there was a general understanding that experience, capability and personal preferences about particular methods varied significantly within the program. An attempt to reach consensus about the best available techniques to use is documented in JGOFS Report 6, "Core Measurement Protocols: Reports of the Core Measurement Working Groups". As JGOFS has grown and diversified, the need for standardization has intensified. The present volume, edited by Dr. Anthony Knap and his colleagues at the Bermuda Biological Station for Research, is JGOFS' most recent attempt to catalog the core measurements and define the current state of the art. More importantly, the measurement protocols are presented in a standardized format which is intended to help new investigators to perform these measurements with some understanding of the procedures needed to obtain reliable, repeatable and precise results.

The job is not finished. For many of the present techniques, the analytical precision is poorly quantified, and calibration standards do not exist. Some of the protocols represent compromises among competing approaches, where none seems clearly superior. The key to further advances lies in wider application of these methods within and beyond the JGOFS community, and greater involvement in modification and perfection of the techniques, or development of new approaches. Readers and users of this manual are encouraged to send comments, suggestions and criticisms to the JGOFS Core Project Office. A second edition will be published in about two years.

JGOFS is most grateful to Dr. Knap and his colleagues at BBSR for the great labor involved in creating this manual. Many scientists besides the Bermuda group also contributed to these protocols, by providing protocols of their own, serving on experts' working groups, or reviewing the draft chapters of this manual. We thank all those who contributed time and expertise toward this important aspect of JGOFS. Finally, we note the pivotal role played by Dr. Neil Andersen, US National Science Foundation and Intergovernmental Oceanographic Commission, in motivating JGOFS to complete this effort. His insistence on the need for a rigorous, analytical approach employing the best available techniques and standards helped to build the foundation on which the scientific integrity of JGOFS must ultimately rest.

Hugh Ducklow
Andrew Dickson
January 1994

Chapter 1. Introduction

The Joint Global Ocean Flux Study (JGOFS) is an international and multi-disciplinary study with the goal of understanding the role of the oceans in global carbon and nutrient cycles. The Scientific Council on Ocean Research describes this goal for the international program: "To determine and understand the time-varying fluxes of carbon and associated biogenic elements in the ocean, and to evaluate the related exchanges with the atmosphere, sea floor and continental boundaries." As part of this effort in the United States, the National Science Foundation has funded two time-series stations, one in Bermuda and the second in Hawaii and a series of large process-oriented field investigations.

This document is a methods manual describing many of the current measurements used by scientists involved in JGOFS. It was originally based on a methods manual produced by the staff of the US JGOFS Bermuda Atlantic Time-series Study (BATS) as part of their efforts to document the methods used at the time-series station. It has been modified through the comments of many JGOFS scientists and in its present form is designed as an aid in training new scientists and technicians in JGOFS style methods. An attempt was made to include many JGOFS scientists in the review of these methods. However, total agreement on the specifics of some procedures could not be reached. This manual is not intended to be the definitive statement on these methods, rather to serve as a high quality reference point for comparison with the diversity of acceptable measurements currently in use.

Presented in this manual are a set of accepted methods for most of the core JGOFS parameters. We also include comments on variations to the methods and in some cases, make note of alternative procedures for the same measurement. Careful use of these methods will allow scientists to meet JGOFS and WOCE standards for most measurements. The manual is designed for scientists with some previous experience in the techniques. In most sections, reference is made to both more complete detailed methods and to some of the authorities on the controversial aspects of the methods.

The organization and editing of this manual has been largely the effort of the scientists and technicians of the BATS program as administered by the Bermuda Biological Station For Research, Inc. (Dr. Anthony H. Knap as principal investigator). A large number of scientists from around the world submitted valuable comments on the earlier drafts. We acknowledge the considerable input from our colleagues at the Hawaii Ocean Time-series (HOT) and members of the methods groups of the international JGOFS community. The Group of Experts on Methods, Standards and Intercalibration (GEMSI), jointly sponsored by the Intergovernmental Oceanographic Commission and the United Nations Environment Programme, have also reviewed this document. The support for compilation of this work was provided in part by funds from the United States National Science Foundation OCE-8613904; OCE-880189.

Dr. Anthony H. Knap
Chairman, IOC/UNEP - GEMSI

Chapter 2. Shipboard Sampling Procedures

1.0 Introduction

Described here is a model sampling scheme that uses the methods in this manual. It is based on the core monthly time-series cruises of the Bermuda Atlantic Time-series Study (BATS). This sequence is described for illustrative purposes. The actual cruise plan for a specific experiment is determined by the scientific objectives and logistical constraints. The order of sampling from each CTD cast may vary, but some of the general patterns (i.e. sampling gases immediately after retrieval of the cast) will hold for all programs.

Each BATS cruise is four to five days duration and occur at biweekly to monthly intervals. The core set of measurements are collected on two hydrocasts, one measurement of integrated primary production and a sediment trap deployment of three days duration. These cruises usually follow a regular schedule for the sequence and timing of events. Weather, equipment problems and other activities occasionally cause this schedule to be interrupted or rearranged. In the data report for each cruise, the exact schedule actually used should be reported, including the timing and nature of other activities. The schedule described below represents a summary of all the core activities on each cruise in the order that they would be performed barring any other factors.

Immediately after arrival near the station (31° 50' N, 64° 10' W), the sediment traps are deployed. This trap array has Multi-traps at 150, 200, and 300 m depths. The trap is free-floating and equipped with a strobe, radio beacon and an ARGOS satellite transmitter. The ship remains near the trap for the rest of the sampling period (see production section below) resulting in a quasi-Lagrangian sampling plan. The locations of each cast are reported with the data reports. The decision to keep the ship near the drifting trap is done for logistical reasons only. In other studies, casts at a fixed location may be preferred.

2.0 Hydrocasts

The core measurements require 2 hydrocasts using the 24 place rosette system. The deeper of the two casts is usually done first. 24 discrete water samples are taken on each cast with the 12 l Niskin bottles.

The cast order is as follows:

Cast 1: 0–4200 m. Bottle samples (24) are collected at 4200, 4000, 3800, 3400, 3000 (duplicates), 2600, then at 200 m intervals until 1400 m, and at 100 m intervals from 300–1400 m.

Cast 2: 0–250 m. 2 bottles are closed at each of 12 depths of 250, 200, 160, 140, 120, 100, 80, 60, 40, 20 and the surface. The extra pair of bottles are closed at the subsurface chlorophyll *a* maximum as determined by the fluorescence profile on the downcast. Gases, nutrients and dissolved organic matter samples are taken from this cast, as well as water samples for particulate organic carbon and particulate nitrogen, pigments and bacterial abundance.

3.0 Water Sampling

- 3.1 Sampling begins immediately after the rosette is brought on board and secured. Care should be taken to protect the rosette sampling operation from rain, wind, smoke or other variables which may effect the samples. Oxygen samples are drawn first (if freon and/or helium is sampled, they should be drawn before the oxygen samples). Two 115 ml BOD bottles are filled from each Niskin and the order of the two samples is recorded. One set of BOD bottles is for the first oxygen sample, termed O₂-1 and a different and distinct set is for the second oxygen sample which is termed the replicate oxygen sample or O₂-2 in all data records. After the oxygens, samples for total CO₂ and alkalinity (only taken on cast 2) are drawn, followed by a single salinity sample. This sampling order is common to all the bottles in the two casts. The remainder of the sampling differs depending on the depth.
- 3.2 The next step in the sampling is drawing particulate organic carbon and nitrogen samples, followed by nutrient samples. Samples for bacterial enumeration are drawn at 3000 and 4000 m and most of the shallow depths. The replicate depths in cast 2 are used for chlorophyll determination, bacterial enumeration and samples for HPLC determination of pigments.
- 3.3 Deckboard water-processing activities are usually divided into specific tasks. Two or three people draw the water, while one person adds reagents to the oxygen samples and keeps track of the sampling operation. Bottle numbers for each sample at each depth are determined before the cast. All of the sampling people are informed of the sampling scheme and the oversight person ensures that it is being carried out accurately.

4.0 Primary Production

The primary production cast is generally performed on the second day, depending on the weather, time of arrival at station, etc. The dawn to dusk in situ production measurement involves the pre-dawn collection of water samples at 8 depths using trace-metal clean sampling techniques. A length of Kevlar hydrowire has been mounted on one of the winches. The bottles are 12 liter Go-Flos with Viton O-rings. These Go-Flos are acid cleaned with 10% HCl between cruises. The bottles are mounted on the Kevlar line and depths are measured with a metered block, or premeasured before the cast, and marked with tape. These samples are brought back on deck, transferred in the dark to 250 ml incubation flasks, ¹⁴C added and the flasks attached to a length of polypropylene line at each depth of collection. This array is deployed with surface flotation which includes a radio beacon and a flasher. The ship follows this production array during the 12–15 hour period that it is deployed, occasionally shuttling back to the sediment trap location. This array is recovered at sunset and processed immediately.

5.0 Sediment Trap Deployment and Recovery

Upon arrival at the BATS station, the sediment trap array is deployed and allowed to drift free for a 72 hour period. The array's location is monitored via the ARGOS transponder and by regular relocation by the ship. Twice daily, the trap position is radioed to the ship by BBSR personnel. The rate of drift can be considerable, as much as 100 km in three days.

6.0 Shipboard Sample Processing

Most of the actual sample analysis for the short BATS cruises is done ashore at the Bermuda Biological Station for Research. Oxygen samples are analyzed at sea because of concerns regarding the storage of these samples for periods of two to three days. Oxygen samples collected on the last day are sometimes returned to shore for analysis. All of the other measurements have preservation techniques that enable the analysis to be postponed. See the individual chapters for details. For longer cruises, it is strongly recommended that analytical work be carried out at sea for best results.

Chapter 3. CTD and Related Measurements

1.0 Scope and field of application

This chapter describes an appropriate method for a SeaBird CTD. The CTD with additional sensors is used to measure continuous profiles of temperature, salinity, dissolved oxygen, downwelling irradiance, beam attenuation and *in vivo* fluorescence. Other CTD systems are available, the details of which will not be discussed here. Individual research groups have developed a wide variety of methods of handling CTD data, some of which differ significantly from the method presented here. The BATS (Bermuda Atlantic Time-series Study) methods are presented as one example that gives good results in most conditions. As presented, they are specific to the SeaBird CTD and software. Most of the post-cruise processing can easily be modified to the data collected by other CTD systems.

JGOFS also recognizes certain protocols and standards adopted by the World Ocean Circulation Experiment (WOCE). In regard to CTD measurements of other hydrographic properties, we note the availability of the WOCE Operations Manual, particularly Volume 3, The Observational Programme; Section 3.1, WOCE Hydrographic Programme; Part 3.1.3, WHP Operations and Methods. This manual contains the reports and recommendations of a group of experts on calibration and standards, water sampling, CTD methods, etc. This report was published by the WOCE WHP Office in Woods Hole as WOCE WHP Office Report WHPO 91-1 (WOCE Report 68/91, July 1991). Copies are available on request from the SCOR Office at the Department of Earth and Planetary Sciences, The Johns Hopkins University, Baltimore, MD, 21201, USA (OMNET: E.GROSS.SCOR, fax +1-410-516-7933), or directly from the WHP Office, WHOI, Woods Hole, MA 02543 USA.

2.0 Apparatus

The SeaBird CTD instrument package is mounted on a 12 or 24 position General Oceanics Model 1015 rosette that is typically equipped with 12 l Niskin bottles. The package can be deployed on a single conductor hydrowire.

2.1 The Seabird CTD system consists of an SBE 9 underwater CTD unit and an SBE 11 deck unit. There are four principal components: A pressure sensor, a temperature sensor, a flow-through conductivity sensor and a pump for the conductivity cell and oxygen electrode. The temperature and conductivity sensors are connected through a standard Seabird "TC-Duct". The duct ensures that the same parcel of water is sampled

by both sensors which improves the accuracy of the computed salinity. The pump used in this system ensures constant sensor responses since it maintains a constant flow through the “TC-Duct”. The pressure sensor is insulated by standard SeaBird methods which reduces thermal errors in this signal.

- 2.1.1 *Pressure*: SeaBird model 410K-023 digiquartz pressure sensor with 12-bit A/D temperature compensation. Range: 0–7000 dBar. Depth resolution: 0.004% full scale. Response time: 0.001 s.
- 2.1.2 *Temperature*: SBE 3–02/F. Range: -5 to 35°C. Accuracy $\pm 0.003^\circ\text{C}$ over a 6 month period. Resolution: 0.0003°C . Response time: 0.082 s at a drop rate of 0.5 m/sec.
- 2.1.3 *Conductivity*: (flow-through cell): SBE 4-02/0. Range 0-7 Siemens/meter. Accuracy ± 0.003 S/m per year. Resolution: 5×10^{-5} S/m. Response time: 0.084 s at a 0.5 m/s drop rate with the pump.
- 2.1.4 *Pump*: SBE 5-02. Typical flow rate for the BBSR system is approx. 15 ml/s. (The pump is used to control the flow through the conductivity cell to match the response time to the temperature sensor. It is also used to pull water through the dissolved oxygen sensor.)
- 2.2 *Dissolved Oxygen*: (Flow-through cell): SBE 13-02 (Beckman polarographic type) Range: 0-15 ml/l. Resolution: 0.01 ml/l. Response time: 2 seconds.
- 2.3 *Beam Transmission*: Sea Tech, 25 cm path-length. Light source wavelength = 670 nm. Depth range 0–5000 m.
- 2.4 *Downwelling Irradiance* (PAR): Biospherical QSP-200L, logarithmic output, irradiance profiling sensor. Uses a spherical irradiance receiver (no cosine collector in use). Spectral response — equal quantum response from 400–700 nm wavelengths. Depth range: 0–1000 m. Used in conjunction with a Biospherical QSP-170 deckboard unit for measuring surface irradiance (PAR).
- 2.5 *Fluorescence*: Sea Tech SN/83 (plastic housing). Three sensitivity settings: 0–3 mg/m^3 (used in BATS), 0–10 mg/m^3 , and 0–30 mg/m^3 . Excitation: 425 nm peak, 200 nm FWHM. Emission: 685 nm peak, 30 nm FWHM. The fluorescence unit is rated to 500 m depth and is only used on the shallow casts. Connecting the fluorescence unit requires disconnecting and rearranging some of the other instruments. The oxygen sensor is disconnected. The transmissometer is plugged into the dissolved oxygen sensor socket, and the fluorometer plugged into the transmissometer socket.

The temperature transducer and conductivity cell are returned to SeaBird approximately once/twice a year for routine calibration by the NWRCC. The dissolved oxygen sensor is returned to SeaBird every six months for calibration; however, if the performance of the cell is found to be suspect, it is returned more frequently. The pressure transducer is calibrated less frequently and it is usual that this calibration is performed during complete CTD maintenance checks or upgrades at SeaBird.

3.0 Data Collection

The CTD package is operated as per SeaBird's suggested methods. The data from the package pass through a SeaBird deck unit and a General Oceanics deck unit before being stored on the hard disk of a PC-compatible portable computer. The CTD is powered with a single conducting electro-mechanical cable. This single conductor is unable to maintain power to the CTD during bottle fires. During this time, the CTD is kept at the desired depth for 90-120 seconds, after which time a software bottle marker is created. Following the mark, the bottle is immediately fired, which takes approximately 20 seconds during which time the CTD is depowered. Once power has returned to the CTD, the package is further maintained at depth for 120 seconds. After this period, the CTD sensors are found to be stable which permits the continuation of the upcast.

The data acquisition rate is 24 samples per second (Hz). The SeaBird deck unit averages these data to 2 Hz in real time. Averaging in the time-domain helps reduce salinity spiking. The 2 Hz data are subsequently stored on the PC. After each cast, a CTD log sheet is completely filled out (Figure 1). The ship's position is recorded directly from the GPS and Loran system. We use the Loran TD values rather than the Loran unit's calculated position which is not usually current. Relevant information such as weather conditions are added in the notes section.

The file naming convention used for BATS CTD data is as follows:

GF##C@@

is the cruise number (e.g. 08 for the eighth BATS cruise)

@@ is the cast number on that cruise (e.g. 04 for the fourth cast)

The SeaBird software produces four files for each cast using the above BATS prefix convention. The four files are:

GF##C@@.DAT	Raw 2 Hz data file, binary
GF##C@@.HDR	Header file, lat, long, time, etc.
GF##C@@.CFG	Configuration file, containing instrument configuration and calibrations used by the software
GF##C@@.MRK	Mark file, a record of all parameters when each bottle is fired

After the cast is complete, these four files are immediately backed up onto floppy disks. SeaBird data acquisition and processing software are used during the cruise for preliminary observations of raw data. The programs are:

SEASAVE: Display, recording and playback of data.

SEACON: Entry of calibration coefficients and recording of the configuration.

SPLITCTD: Split file into separate up and down casts.

BINAVG: Bin averages existing SEASAVE data files and converts to ASCII text.

In addition, the matrix manipulation program Matlab (The Math Works, Inc., 21 Elliot Street South Natick, MA 01760 USA) is used for post-cruise calibration of data with the discrete samples.

4.0 Data Processing

Data processing can be done on a UNIX workstation or IBM compatible microcomputer using the SeaBird software and Matlab. The raw 2 Hz data are first converted to an ASCII format. At this stage, a pressure filter is applied which effectively eliminates all scans for which the CTD speed through the water column is less than 0.25 ms^{-1} . Each profile is then plotted and visually examined for bad data and spikes which are removed. The salinity and dissolved oxygen data are then passed through a 7 point median filter to systematically eliminate spikes. The oxygen data are further smoothed by the application of a 17 point running mean. The necessary sensor corrections are then applied to obtain a calibrated 2 Hz data stream (see below). Finally, for data submission and distribution, the data are bin averaged to 2 dbar resolution.

4.1 *Temperature Corrections:* The SeaBird temperature sensors (SBE 3-O2/F) are found to have characteristic drift rates. The drift is a linear function of time with a dependency on temperature. For each cruise the calibration history of the sensor is used to determine an offset and slope value. The corrected temperature measurement is given by:

$$T = T_u + D$$

$$D = a + b \times T_u$$

where:

T	=	corrected <i>in situ</i> temperature (°C)
T_u	=	uncorrected <i>in situ</i> temperature (°C)
D	=	net drift correction
a	=	F(t), drift offset correction (°C)
b	=	F(t), drift slope correction (°C)

- 4.2 *Salt Corrections:* The salinity calculated from the conductivity sensor is calibrated using the discrete salinity measurements collected from the Niskin bottles on the rosette. The samples from the entire cruise are combined to give an ensemble of 36 samples in the depth range 0-4200 m. The bottle salinity samples from the upcast are mapped to the downcast CTD salinity trace, at the temperature of the Niskin closure. These matched pairs from all associated casts are grouped together and used to determine a specific salinity correction. The deviation between the bottle salinity and CTD values is regressed against pressure, temperature and the uncorrected CTD salinity using a polynomial relationship:

$$dS = R_0 + \sum_{i=1}^l A_i \left(\frac{P}{4300} \right)^i + \sum_{i=1}^m B_i \left(\frac{T}{30} \right)^i + \sum_{i=1}^n C_i \left(\frac{S_u}{37} \right)^i$$

$$S = S_u + dS$$

where:

dS	=	model (measured bottle salinity - CTD salinity)
S	=	calibrated salinity
R_0	=	offset
P	=	gauge pressure (dbar)
T	=	temperature (°C)
S_u	=	uncorrected CTD salinity
A_i, B_i, C_i	=	regression coefficients
l, m, n	=	order of the polynomial functions (usually = 3)

The order of each polynomial is modified for each cast to provide the best fit for the lowest order polynomial. The F-test indicates the statistical significance of the model. The r^2 value predicts the amount of variance explained by the model. The r^2 value and a graphical examination of the model residuals are used to determine the best form of the polynomial expression. The standard deviation of the residuals is typically less than 0.003. The consequent regression relationship is used to modify the CTD salinity values from the downcast profile and the regression relationship is reported with the CTD data.

- 4.3 *Oxygen Corrections:* In early cruises, the oxygen sensor was calibrated before each cruise. Saturated water was made by bubbling air from a SCUBA tank through tap

water for 5–10 hours. Oxygen free water was made by adding 3% sodium sulfite. The current (μA), temperature and barometric pressure were recorded for both solutions and entered into the SeaBird program OXFIT to calculate the calibration factors for the oxygen sensor. Nevertheless, the oxygen sensor gives a very poor fit to the bottle data, probably because of both pressure and temperature hysteresis effects. There are 36 replicate discrete oxygen samples from 0–4200 m. These oxygen samples from the upcast are mapped to the downcast profile at the temperature of the Niskin closure. These matched pairs from all associated casts are grouped together to determine a single equation for the complete depth range. The measured bottle oxygen values are regressed against temperature, pressure, oxygen current, oxygen temperature and oxygen saturation such that the CTD oxygen is directly predicted by the following equation:

$$MO = R_0 + \sum_{i=1}^l A_i \left(\frac{P}{4300} \right)^i + \sum_{i=1}^m B_i \left(\frac{T}{30} \right)^i + \sum_{i=1}^n C_i (OC)^i + \sum_{i=1}^o D_i \left(\frac{OS}{300} \right)^i$$

where:

MO	= model CTD oxygen
R_0	= linear offset
P	= pressure (dbar)
T	= temperature ($^{\circ}\text{C}$)
OC	= oxygen sensor current (μA)
$OS(T,p,S)$	= oxygen saturation value at measured temperature, salinity and pressure (μmolkg)
A_i, B_i, C_i, D_i	= regression coefficients
l, m, n, o	= order of the polynomial functions ($l = 3$, rest usually = 2)

The order of each polynomial is determined by comparing successive fits until the correlation coefficients stabilize, and the residuals seem randomly distributed. The standard deviation of the residuals is typically less than $1.5 \mu\text{mol kg}^{-1}$.

- 4.4 *Transmissometer Calibration.* The transmissometer shows frequent offsets in deep water which indicate variations in its performance. The theoretical clear water minimum beam attenuation coefficient is 0.364 (Bishop, 1986). We assume that the minimum beam 'C' value observed at the BATS site in the depth range 3000–4000 m is representative of a clear water minimum. We equate this minimum value with the theoretical minimum to determine an offset correction. The correction is given by:

$$\text{offset} = 0.364 - \text{BAC}_{\min}$$

where BAC_{\min} =minimum beam 'C' for $3000 \text{ m} < \text{depth} < 4000 \text{ m}$. This offset is applied to the entire profile.

The Sea Tech transmissometers used on these cruises have had a series of problems, some of them associated with component failures on the deeper casts. Other problems are associated with the temperature compensation unit in the transmissometer. These temperature related problems give rise to a variety of suspect behaviors: 1) high surface values (well beyond normal) that correlate with the time of day (highest at noon), 2) exponential decay within and below the mixed layer, 3) linear or exponential decays in the permanent thermocline, and 4) high cast to cast variability, even in deep water. The ability to distinguish between genuine patterns and instrument problems can be difficult.

- 4.5 *Fluorometer Calibration.* The fluorometer returns a voltage signal that is processed by the SEASOFT software to a chlorophyll concentration. There is a standard instrument offset which is determined from the voltage reading on deck with the light sensor blocked off. There is a "scale factor" which is determined for each chlorophyll range. The BATS fluorometer is scaled to read chlorophyll from 0 - $1.5 \mu\text{g l}^{-1}$.

In addition to the standard offset, there is a post cruise offset that is applied considering the measured chlorophyll concentration in the water column. This "field offset" is determined using the data from 250 m depth:

$$\text{Field Offset} = \text{Extracted chlorophyll (@ 250 m)} - \textit{in situ} \text{ fluorometer chlorophyll (@ 250 m)}$$

This offset procedure is applied to all of the CTD casts on that cruise. Further regression analysis of bottle chlorophyll versus fluorometry or HPLC chlorophyll can also be performed.

5.0 References

- Bishop, J. (1986). The correction and suspended particulate matter calibration of Sea Tech transmissometer. *Deep-Sea Research* **91**, 7761–7764.
- SeaBird Electronics, Inc. CTD Data Acquisition Software manual.

CTD LOG SHEET

Cruise:	Leg:	Station:
Cast #:	Type:	Date:

CTD status	time(LT)	lat (1)	long (1)	system (1)	lat (2)	long (2)	system (2)
in water							
on deck							

CTD Model		
Sensors (tick)	Serial number	Comments (offsets, performance, etc.)
Cond		
Press		
Temp		
Oxy		
Trans		
Fluor		
PAR		
SPAR		
Bottles		
Other		

Niskin #	Time tripped	Depth (M or db)	Desired depth (m)	Comments (misfiring, leaking, etc.)
1				
2				
3				
4				
5				
6				
7				
8				
9				
10				
11				
12				

Software version _____:

Averaging scheme:

Raw data Filename _____:

Split Files _____:

Plots created _____:

Weather and Sea Conditions

wind speed: wind dirn: gusts:
 seastate: swell: local wind waves:
 sun intensity: cloud cover:
 air temp: rainfall:
 met. synopsis

Additional comments

Figure 1. Sample BATS CTD Log Sheet.

Chapter 4. Quality Evaluation and Intercalibration

1.0 Introduction

The measurements described in the next chapters provide part of the core set of data for the scientists of JGOFS and the U.S. JGOFS Bermuda Atlantic Time-series Study (BATS). The continuous CTD data are calibrated by the bottle-collected salinity and oxygen data. Most of the techniques are standard and widely used. However, there are also numerous ways that the data can be inaccurate, from mechanical failure of the Niskin bottles to accidents in the laboratory. Since these kinds of problems are unavoidable, a lab must set up a series of procedures for checking the data both internally (consistency with the other similar data) and externally (consistency with historical data for the area and intercalibrations with other labs). These quality control methods are used primarily to evaluate the salinity, dissolved oxygen, dissolved inorganic carbon, and nutrient data, and to a lesser extent the particulate and rate measurements. The methods used in the BATS program are presented here as an illustration of a procedure that might be applicable to similar datasets.

The measures that BATS employs are a combination of formal and informal examinations of the data for inconsistencies and errors. The technicians who are making the measurements are well trained and make the same measurements month to month. They often spot an error in the data set as the number is being generated or as the data are entered into the computer. They know the values that they usually get at each depth and can spot many of the outliers. Such points are not automatically discarded. The identification of an aberrant result, either at this step or in the subsequent examinations, is only cause for rechecking the previous steps in the data generation process (sampling, analysis, data entry and calculation, etc.) for inadvertent errors. If no inadvertent error can be found, then a decision must be made. If the datum is out of the bounds of possibility the datum is likely discarded (see below).

The next step in data inspection is to graph the data with depth and visually examine the profile. At this step, aberrant points can also become evident as deviations from the continuity of the profile. These deviations are checked as above. The other analyses of samples from the same Niskin bottle are also examined to see if they all are aberrant, indicating that the bottle misfired or leaked. If a bottle appears to have leaked, all the measurements from that bottle are discarded, even if some of them appear to fall within the correct range.

Other graphical methods are also employed to examine the data. T-S diagrams are plotted and compared with historical data. Nutrients are plotted against temperature and density and against each other. Contour plots of a measurement on axes of potential density and time are particularly useful in identifying anomalous data and calibration errors. Nitrate-phosphate plots have proved very useful in identifying both individual and systematic problems in those nutrient data.

The final examination procedure is the comparison with a carefully selected set of data called our QC windows. In our case, this is a data set compiled by G. Heimerdinger (National Oceanic Data Center) from a number of cruises to within 200 miles of Bermuda between 1975 and 1985. These are data that he believes are of high quality and also reflect the kinds of variation that would be seen at the BATS station. Salinity and oxygen are well represented in

this data set, while nutrients are present for only four cruises. G. Heimerdinger is constantly expanding this QC data set. As the BATS data grows, we have compiled a second set of QC windows from BATS data to compliment G. Heimerdinger's. The BATS data are graphically overlaid on both sets of the QC data and both systematic and individual variations noted and checked carefully as above. Similar data can be compiled to construct QC windows for other ocean regions. This may not be helpful in coastal areas with great variability.

The most difficult problems to resolve are small systematic deviations from the QC envelopes. We are unwilling to automatically discard every deviation from the existing data, especially when they can find no reason that a previously reliable analysis should show the deviation. If the measurements were meant to come out invariant, there would be no reason to collect new data. Therefore, some of the data that are reported deviate from the QC envelope and it is left to others to decide whether they agree with the values. These deviations are noted in the cruise summaries that accompany each data report. BATS does not flag individual values. In the WOCE program the data reporting system is different. All of the measurements are reported and each is accompanied by a quality flag (see WOCE Manual cited previously).

Finally, one must constantly expand the methods used to check data quality. For many measurements, BATS has added internal standards, sample carry-overs between months and other procedures to prevent accuracy and standardization biases from giving false temporal change. They are currently involved in a number of intercalibration/intercomparison efforts between the BATS lab and other laboratories that regularly make these kinds of analyses. The results of these intercalibrations (and other types of methods checks) are reported in regular data reports.

Chapter 5. Salinity Determination

1.0 Scope and field of application

This procedure describes the method for the determination of seawater salinity. The method is suitable for the assay of oceanic levels (0.005–42). The method is suitable for the assay of oceanic salinity levels of 2–42. This method is a modification of one published by Guildline Instruments (1978).

2.0 Definition

The method determines the practical salinity (S) of seawater samples which is based on electrical conductivity measurements. The Practical Salinity Scale 1978 (PSS 78) defines the practical salinity of a sample of seawater in terms of the conductivity ratio (K_{15}) of the conductivity of the sample at a temperature of 15°C and pressure of one standard atmosphere to that of a potassium chloride (KCl) solution containing 32.4356 g of KCl in a mass of 1 kg of solution.

3.0 Principle

A salinometer is used to measure the conductivity ratio of a sample of seawater at a controlled temperature. The sample is continuously pushed through an internal conductivity cell where electrodes initiate signals that are proportional to the conductivity of the sample. Using an internal preset electrical reference, these signals are converted to a conductivity ratio value. The number displayed by the salinometer is twice the conductivity ratio. The internal reference is standardized against the recognized IAPSO standard seawater.

4.0 Apparatus

Guildline model 8400A Autosol Salinometer. The Autosol has a 4 electrode cell which measures the conductivity ratio of a sample seawater in less than one minute. The salinity range of the instrument is about 0.005–42 and has a stated accuracy of ± 0.003 by the manufacturer. In practice, accuracies of 0.001 are possible with careful analysis.

5.0 Reagents

IAPSO Standard Seawater. Standard seawater for instrument calibration.

6.0 Sampling

Salinity samples are collected from Niskin bottles at all depths. These samples are collected after the oxygen and CO₂ samples have been drawn. The bottles used are 125 and 250 ml borosilicate glass bottles with plastic screw caps. A plastic insert is used in the cap to form a better seal. The remaining sample from the previous use is left in the bottles between uses to prevent salt crystal buildup from evaporation and to maintain an equilibrium with the glass. When taking a new sample, the old water is discarded and the bottle is rinsed three times with water from the new sample. It is then filled to the bottle shoulder with sample. The neck of the bottle and inside of the cap are dried with a Kimwipe. The cap is then replaced and firmly tightened. These samples are stored in a temperature controlled laboratory for later analysis (1-5 days after collection). Every six months the bottles are acid washed (1 M HCl), rinsed with deionized and Milli-Q water. After this cleaning they are rinsed five times with copious amounts of sample before filling.

7.0 Procedures

The samples are analyzed on a Guildline AutoSal 8400A laboratory salinometer using the manufacturer's recommended techniques.

The salinometer is calibrated with IAPSO standard seawater. Two standards are run prior to running the samples. If those two standards agree, the samples are run. At the end of the run, two new standards are run to check for instrument drift. The drifts are generally found to be zero. Using this procedure, the instrument can give a salinity precision of ± 0.001 -0.002.

8.0 Calculation and expression of results

The calculation of salinity is based on the 1978 definition of practical salinity (UNESCO, 1978). The following gives the necessary computation to calculate a salinity (S) given a conductivity ratio determined by the salinometer:

$$S = a_0 + a_1 R_T^{\frac{1}{2}} + a_2 R_T + a_3 R_T^{\frac{3}{2}} + a_4 R_T^2 + a_5 R_T^{\frac{5}{2}} \\ + \frac{T-15}{1+kT-15} \left\{ b_0 + b_1 R_T^{\frac{1}{2}} + b_2 R_T + b_3 R_T^{\frac{3}{2}} + b_4 R_T^2 + b_5 R_T^{\frac{5}{2}} \right\}$$

where:

$a_0 = 0.0080$	$b_0 = 0.0005$
$a_1 = -0.1692$	$b_1 = -0.0056$
$a_2 = 25.3851$	$b_2 = -0.0066$
$a_3 = 14.0941$	$b_3 = -0.0375$
$a_4 = -7.0261$	$b_4 = 0.0636$
$a_5 = 2.7081$	$b_5 = -0.0144$
$k = 0.0162$	

R_T = conductivity ratio of sample (=0.5 salinometer reading)

T = bath temperature of salinometer ($^{\circ}\text{C}$)

$$\sum_{i=0}^5 a_i = 35.0000$$

$$\sum_{i=0}^5 b_i = 0.0000$$

for:

$$\begin{array}{ccccccc} -2^{\circ}\text{C} & \leq & T & \leq & 35^{\circ}\text{C} \\ 2 & \leq & S & \leq & 42 \end{array}$$

9.0 Quality assurance

- 9.1 *Quality control:* The bottle salinities are compared with the downcast CTD profiles to search for possible outliers. The bottle salinities are plotted against potential temperature and overlaid with the CTD data. Historical envelopes from the time-series station are further overlaid to check for calibration problems or anomalous behavior.
- 9.2 *Quality assessment:* Deep water samples (>3000 m) are duplicated. These replicate samples are found to agree in salinity of ± 0.001 .
- 9.3 Regular intercalibration exercises should be performed with other laboratories.

10.0 References

- Guildline Instruments. (1981). Technical Manual for 'Autosal' Laboratory Salinometer Model 8400.
- UNESCO. (1978). *Technical Papers in Marine Science*, **28**, 35pp.

Chapter 6. Determination of Dissolved Oxygen by the Winkler Procedure

1.0 Scope and field of application

This procedure describes a method for the determination of dissolved oxygen in seawater, expressed as $\mu\text{mol kg}^{-1}$. The method is suitable for the assay of oceanic levels, e.g. 0.5 to 350 $\mu\text{mol kg}^{-1}$ of oxygen in uncontaminated seawater and is based on the Carpenter (1965) modification of the traditional Winkler titration. As described it is somewhat specific to an automated titration system. A manual titration method is also described. There are currently alternative methods of assessing the endpoint (e.g., potentiometric) that give comparable precision, but these are not described here. This method is unsuitable for seawater containing hydrogen sulfide.

2.0 Definition

The dissolved oxygen concentration of seawater is defined as the number of micromoles of dioxygen gas (O_2) per kilogram of seawater ($\mu\text{mol kg}^{-1}$).

3.0 Principle of Analysis

The chemical determination of oxygen concentrations in seawater is based on the method first proposed by Winkler (1888) and modified by Strickland and Parsons (1968). The basis of the method is that the oxygen in the seawater sample is made to oxidize iodine ion to iodine quantitatively; the amount of iodine generated is determined by titration with a standard thiosulfate solution. The endpoint is determined either by the absorption of ultraviolet light by the tri-iodide ion in the automated method, or using a starch indicator as a visual indicator in the manual method. The amount of oxygen can then be computed from the titer: one mole of O_2 reacts with four moles of thiosulfate.

More specifically, dissolved oxygen is chemically bound to Mn(II)OH in a strongly alkaline medium which results in a brown precipitate, manganic hydroxide (MnO(OH)_2). After complete fixation of oxygen and precipitation of the mixed manganese (II) and (III) hydroxides, the sample is acidified to a pH between 2.5 and 1.0. This causes the precipitated hydroxides to dissolve, liberating the Mn(III) ions. The Mn(III) ions oxidize previously added iodide ions to iodine. Iodine forms a complex with surplus iodide ions. The complex formation is desirable because of its low vapor pressure, yet it decomposes rapidly when iodine is removed from the system. The iodine is then titrated with thiosulfate: iodine is reduced to iodide and the thiosulfate is oxidized to tetrathionate. The stoichiometric equations for the reaction described above are:

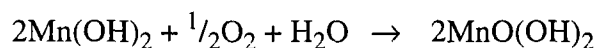

The thiosulfate can change its composition and therefore must be standardized with a primary standard, typically potassium iodate. Standardization is based on the co-proportionation reaction of iodide with iodate, thereby forming iodine. As described above, the iodine binds with excess iodide, and the complex is titrated with thiosulfate. One mole of iodate produces three moles iodine, and amount consumed by six moles of thiosulfate.



4.0 Apparatus

4.1 Sampling apparatus

- 4.1.1 *Sample flasks*: custom made BOD flasks of 115 ml nominal capacity with ground glass stoppers. The precise volume of each stopper-flask pair is determined gravimetrically by weighing with water. It is essential that each individual flask/stopper pair be marked to identify them and that they be kept together for subsequent use.
- 4.1.2 *Pickling reagent dispensers*: two dispensers capable of dispensing 1 ml aliquots of the pickling reagents. The accuracy of these dispensers should be 1% (i.e. 10 μl).
- 4.1.3 *Tygon[®] tubing*: long enough to reach from spigot to the bottom of the sample bottle.
- 4.1.4 *Thermometers*: one thermometer is used to measure the water temperature at sampling to within 0.5°C. Two platinum resistance temperature sensors are used to monitor the temperatures of the titrating solutions in the laboratory.

4.2 Manual titration apparatus

- 4.2.1 *Titration box*: a three-sided box containing the titration apparatus. The walls should be painted white to aid in end point detection.
- 4.2.2 *Dispenser*: capable of delivering 1 ml aliquots of the sulfuric acid solution.
- 4.2.3 *Burette*: a piston burette capable of dispensing 1 ml and 10 ml of KIO_3 for blank determination and thiosulfate standardization. An alternate, precisely calibrated dispenser may be used for these steps.
- 4.2.4 *Magnetic stirrer and stir bars*.
- 4.2.5 *Burette*: a piston burette with a one milliliter capacity and anti diffusion tip for dispensing thiosulfate.

4.3 Automated titration apparatus

- 4.3.1 *Metrohm 655 Dosimat burette*: a piston burette capable of dispensing 1 to 10 ml of KIO_3 for blank determination and standardization.
- 4.3.2 *Metrohm 665 Dosimat Oxygen Auto-titrator*. The apparatus used for this technique consists of a thiosulfate delivery system (the Dosimat) and a detector that measures UV transmission through the sample in a custom designed BOD bottle.
- 4.3.3 *AST computer*. The burette, endpoint detector and A/D convertor are controlled by an IBM compatible PC, in a system designed by R. Williams (SIO).
- 4.3.4 *Dispenser*: capable of delivering 1 ml aliquots of the sulfuric acid solution.
- 4.3.5 *Magnetic stirrer and stir bars*.

5.0 Reagents

- 5.1 *Manganese (II) chloride* (3M: reagent grade): Dissolve 600 g of $\text{MnCl}_2 \cdot 4\text{H}_2\text{O}$ in 600 ml distilled water. After complete dissolution, make the solution up to a final volume of 1 liter with distilled water and then filtered into an amber plastic bottle for storage.
- 5.2 *Sodium Iodide* (4M: reagent grade) and *sodium hydroxide* (8M: reagent grade): Dissolve 600 g of NaI in 600 ml of distilled water. If the color of solution becomes yellowish-brown, discard and repeat preparation with fresh reagent. While cooling the mixture, add 320 g of NaOH to the solution, and make up the volume to 1 liter with distilled water. The solution is then filtered and stored in an amber glass bottle.
- 5.3 *Sulfuric Acid* (50% v/v): Slowly add 500 ml of reagent grade concentrated H_2SO_4 to 500 ml of distilled water. Cool the mixture during addition of acid.
- 5.4 *Starch Indicator* (manual titration only): Place 1.0 g of soluble starch in a 100 ml beaker, and add a little distilled water to make a thick paste. Pour this paste into 1000 ml of boiling distilled water and stir for 1 minute. The indicator is freshly prepared for each cruise and stored in a refrigerator until use.
- 5.5 *Sodium Thiosulfate* (0.18 M: reagent grade): Dissolve 45 g of $\text{Na}_2\text{S}_2\text{O}_3 \cdot 5\text{H}_2\text{O}$ and 2.5 g of sodium borate, $\text{Na}_2\text{B}_4\text{O}_7$ (reagent grade) for a preservative, in 1 liter of distilled water. This solution is stored in a refrigerator for titrator use.
- 5.6 *Potassium Iodate Standard* (0.00167M: analytical grade): Dry the reagent in a desiccator under vacuum. Weigh out exactly 0.3567 g of KIO_3 and make up to 1.0 liter with distilled water. Commercially prepared standards can also be used. One ampule of Baker's DILUT-IT KIO_3 analytical concentrate solution is diluted 1:10 to create a 0.0167M stock solution. This solution is diluted 1:10 for titration use, 0.00167M. It is

important to note the temperature of the solution so that a precise molarity can be calculated.

6.0 Sampling

6.1 Collection of water at sea, from the Niskin bottle or other sampler, must be done soon after opening the Niskin, preferably before any other samples have been drawn. This is necessary to minimize exchange of oxygen with the head space in the Niskin which typically results in contamination by atmospheric oxygen.

6.2 *Sampling procedure:*

6.2.1 Before the oxygen sample is drawn the spigot on the sampling bottle is opened while keeping the breather valve closed. If no water flows from the spigot it is unlikely that the bottle has leaked. If water does leak from the bottle it is likely that the Niskin has been contaminated with water from shallower depths. The sample therefore may be contaminated, and this should be noted on the cast sheet.

6.2.2 The oxygen samples are drawn into the individually numbered BOD bottles. It is imperative that the bottle and stopper are a matched pair. Two samples are drawn from each Niskin and the order of sampling is recorded.

6.2.3 When obtaining the water sample, great care is taken to avoid introducing air bubbles into the sample. A 30–50 cm length of Tygon[®] tubing is connected to the Niskin bottle spout. The end of the tube is elevated before the spout is opened to prevent the trapping of bubbles in the tube. With the water flowing, the tube is placed in the bottom of the horizontally held BOD bottle in order to rinse the sides of the flask and the stopper. The bottle is turned upright and the side of the bottle tapped to ensure that no air bubbles adhere to the bottle walls. Four-five volumes of water are allowed to overflow from the bottle. The tube is then slowly withdrawn from the bottle while water is still flowing.

6.2.4 Immediately after obtaining the seawater sample, the following reagents are introduced into the filled BOD bottles by submerging the tip of a pipette or automatic dispenser well into the sample: 1 ml of manganous chloride, followed by 1 ml of sodium iodide-sodium hydroxide solution.

6.2.5 The stopper is carefully placed in the bottle ensuring that no bubbles are trapped inside. The bottle is vigorously shaken, then reshaken roughly 20 minutes later when the precipitate has settled to the bottom of the bottle.

6.2.6 After the second oxygen sample is drawn, the temperature of the water from each Niskin is measured and recorded.

6.2.7 Sample bottles are stored upright in a cool, dark location and the necks water sealed with saltwater. These samples are analysed after a period of at least 6-8 hours but within 24 hours. The samples are stable at this stage.

7.0 Titration Procedures

The basic steps in titrating oxygen samples differ little regardless of whether one uses the manual or the automated procedure. First the precise concentration of the thiosulfate must be determined. Next the blank, impurities in the reagents which participate in the series of oxidation-reduction reactions involved in the analysis, is calculated. Once the standard titer and blank have been determined, the samples can be titrated.

The fundamental differences between the manual and automated titration methods are the means of endpoint detection (visual versus a UV detector) and the method of thiosulfate delivery. The auto-titrator rapidly dispenses thiosulfate. As the changes in UV absorption are noted, the rate is slowed, and finally the continuous addition is stopped. The endpoint is approached by adding ever-smaller increments of thiosulfate until no further change in absorption is detected, indicating that the endpoint has been passed. Standardization, blank determination, and sample analysis are described generically below for both methods, with specifics where warranted.

7.1 *Standardization:*

- 7.1.1 To one BOD bottle add approximately 15 ml of deionized water and a stir bar.
- 7.1.2 Carefully add 10 ml of standard potassium iodate (0.00167 M) from an "A" grade pipette or equivalent or the Metrohm 655 Dosimat. Swirl to mix. Immediately add 1 ml of the 50% sulfuric acid solution. Rinse down sides of flask, swirling to mix, thus ensuring an acidic solution before the addition of reagents.
- 7.1.3 Add 1 ml of sodium iodide-sodium hydroxide reagent, swirl, then add 1 ml of manganese chloride reagent. Mix thoroughly after each addition. Once solution has been mixed, fill to the neck with deionized water.
- 7.1.4 Titrate the liberated iodine with thiosulfate immediately. In the manual method, use the 1 ml burette to titrate the standard with sodium thiosulfate (approximately 0.18 M) until the yellow color has almost disappeared. Add 1–2 ml of the starch indicator, which should turn the solution deep blue to purple in color. Titrate until this solution is just colorless and then record room temperature. This titration should be reproducible to within ± 0.03 ml, once the varying BOD bottle volumes have been accounted for.
- 7.1.5 The automated titrator system delivers 0.2 N thiosulfate to the acidified standard solution and reads the change in UV light absorption in the solution. As the endpoint is approached, it delivers progressively smaller aliquots of thiosulfate until no further change in absorption shows that the endpoint has been reached. The endpoint is determined by a least squares linear fit using a group of data points just prior to the endpoint, where the slope of the titration curve is steep, and a group of points after the endpoint, where the slope of the curve is close to zero. The intersection of the two lines of best fit is taken as the endpoint. Reproducibility should be better than 0.01 ml l⁻¹.

- 7.1.6 The mean value should be found from at least three and preferably five replicate standards, and standards should be run at the beginning, end, and periodically throughout the time that samples are being titrated.

7.2 Blank determination:

- 7.2.1 Place approximately 15 ml of deionized water in a BOD bottle with a stir bar. Add 1 ml of the potassium iodate standard, mix thoroughly, then add 1 ml of 50% sulfuric acid, again mixing the solution thoroughly.
- 7.2.2 Before beginning the titration add the reagents in reverse order: 1 ml of sodium iodide-sodium hydroxide reagent, rinse, mix, then 1 ml of manganese chloride reagent. Fill the BOD bottle to just below the neck with deionized water. Titrate to the endpoint as described for the standardization procedure.
- 7.2.3 Pipette a second 1 ml of the standard into the same solution and again titrate to the end point.
- 7.2.4 The difference between the first and second titration is the reagent blank. Either positive or negative blanks may be found.

7.3 Sample analysis:

- 7.3.1 After the precipitate has settled (at least 6-8 hours for the automated method), carefully remove the sealing water taking care to minimize disturbance of the precipitate. Wipe the top of the flask to remove any remaining moisture and carefully remove the stopper.
- 7.3.2 Immediately add 1 ml of 50% sulfuric acid. Carefully slide a stir bar down the edge of the bottle so as not to disturb the precipitate.
- 7.3.3 Titrate as described in the standardization procedure.

3.0 Calculation and expression of results

The calculation of oxygen concentration ($\mu\text{mol l}^{-1}$) from this analysis follows in principle the procedure outlined by Carpenter (1965).

$$O_2 \text{ (ml/l)} = \frac{(R - R_{b/k}) V_{\text{IO}_3} \cdot M_{\text{IO}_3} \cdot E}{(R_{\text{Std}} - R_{b/k}) (V_b - V_{\text{reg}})} - \text{DO}_{\text{reg}}$$

- R = Sample titration (ml) R_{Std} = Volume used to titrate standard (ml)
 $R_{b/k}$ = Blank as measured above (ml) M_{IO_3} = Molarity of standard KIO_3 (mol/l)
 V_{IO_3} = Volume of KIO_3 standard (ml) E = 5,598 ml O_2 /equivalent
 V_b = Volume of sample bottle (ml) DO_{reg} = oxygen added in reagents
 V_{reg} = Volume of reagents (2 ml)

- 8.1 The additional correction for DO_{reg} of 0.0017 ml oxygen added in 1 ml manganese chloride and 1 ml of alkaline iodide has been suggested by Murray, Riley and Wilson (1968).
- 8.2 *Conversion to $\mu\text{mol/kg}$* : To make an accurate conversion to $\mu\text{moles/kg}$, two corrections are needed: (1) to correct for the actual amount of thiosulfate delivered by the burette (which is temperature dependent); and (2) to correct for the volume of the sample at its drawing temperature. Both calculations are undertaken automatically in many versions of software driven titration. Two pieces of information are required: (a) the temperature of the sample (and bottle) at the time of fixing; the reasonable assumption being that the two are the same; (b) the temperature of the thiosulfate at the time of dispensing. Some versions of the automatic titration may also call for *in situ* temperature, as well as salinity, which allow for the calculation of oxygen solubility and thus the percentage saturation and AOU.

9.0 Quality assurance

- 9.1 *Quality Control*: For best results, oxygen samples should be collected in duplicate from **all** sample bottles. This allows for a real measure of the precision of the analysis on every profile. A mean squared difference (equivalent to a standard deviation of repeated sampling) is the measure of precision for these profiles. As this replication takes into account all sources of variability (e.g. sampling, storage, analysis) it gives a slightly larger imprecision than indicated by the analytical precision of the titration (e.g. repeated measures of standards in the lab). In addition, periodic precision tests are done by collection and analysis of 5–10 samples from the same Niskin bottle. This precision should be better than 0.01 ml l^{-1} . Field precision can vary from 0.005 to 0.03 depending on the sea conditions and the performance of the auto-titrator. Samples are reduced to oxygen concentrations prior to the next cruise to identify degradation of the precision, before too many additional profiles have been collected.
- 9.2 *Quality assessment*: No absolute standard exists for oxygen analysis. Standards are made by gravimetric and volumetric measurements of reagent grade chemicals. Commercially prepared standards such as DILUT-IT can be used for comparison with the freshly made up standard in the lab. Standard solutions are relatively stable and provide an early warning of errors by changes in their titer. Profiles of oxygen are examined visually and numerically. At any depth where the replicates differ by 0.04 ml/l or greater, the samples are carefully scrutinized. The profile is compared with the historical profiles for consistency, particularly in the deep water. These profiles are also compared with the CTD oxygen sensor. Although CTD oxygen sensors are very imprecise and inaccurate, they provide a continuous record. Deviations from the general shape of the profile by a single oxygen sample is evidence of inaccuracy in the wet oxygen measurement.

10.0 References

- Carpenter, J.H. (1965). The Chesapeake Bay Institute. Technique for the Winkler oxygen method. *Limnol. Oceanogr.*, **10**, 141–143.
- Grasshoff, K., Ehrhardt, M., and Kremling, K. (1983). *Methods of Seawater Analysis*. Grasshoff, Ehrhardt and Kremling, eds. Verlag Chemie GmbH. 419 pp.
- Murray J.N., Riley, J.P. and Wilson, T.R.S. (1968). The solubility of oxygen in Winkler reagents used for the determination of dissolved oxygen. *Deep-Sea Res.*, **15**, 237–238.
- Strickland, J.D.H., and Parsons, T.R. (1968). Determination of dissolved oxygen. in *A Practical Handbook of Seawater Analysis*. Fisheries Research Board of Canada, Bulletin, **167**, 71–75.
- Williams, P.J.leB., and Jenkinson, N.W. (1982). A transportable microprocessor-controlled precise Winkler titration suitable for field station and shipboard use. *Limnol. Oceanogr.*, **27** (3), 576–584.
- Winkler, L.W. (1888). Die Bestimmung des in Wasser gelösten Sauerstoffes. *Berichte der Deutschen Chemischen Gesellschaft*, **21**: 2843–2855.

Chapter 7. The Determination of Total Inorganic Carbon by the Coulometric Procedure

1.0 Scope and field of application

This procedure describes a method for the determination of total dissolved inorganic carbon in sea water, expressed as moles of carbon per kilogram of sea water. The method is suitable for the assay of oceanic levels of total dissolved inorganic carbon ($1800\text{--}2300\ \mu\text{mol}\cdot\text{kg}^{-1}$) and also for higher levels such as are found in the Black Sea ($3800\text{--}4300\ \mu\text{mol}\cdot\text{kg}^{-1}$). For a more definitive and comprehensive treatment of the analysis, the reader is referred to the D.O.E. (1991) handbook (Dickson, A.G., and Goyet, C., eds.) and the SOMMA manual (Johnson, 1992). The D.O.E. (1991) handbook by Dickson and Goyet provides protocols for other carbon dioxide system parameters (i.e. pH, TA, $p\text{CO}_2$). Scientists who employ this or other methods to measure total inorganic carbon should make themselves aware of the current and historical issues that surround these techniques and make appropriate decisions about specific methodologies for their application based on the scientific requirements and constraints of their individual programs.

2.0 Definition

The total dissolved inorganic carbon content of seawater is defined as:

$$C_T = [\text{CO}_2^*] + [\text{HCO}_3^-] + [\text{CO}_3^{2-}]$$

where brackets represent total concentrations of these components in solution ($\mu\text{mol}\ \text{kg}^{-1}$), and $[\text{CO}_2^*]$ represents the concentration of all unionized carbon dioxide, whether present as H_2CO_3 or as CO_2 (UNESCO, 1991).

3.0 Principle of Analysis

Total dissolved inorganic carbon (C_T) is measured by acidifying a seawater sample to convert HCO_3^- and CO_3^{2-} to undissociated CO_2 , and then extracting this CO_2 as a gas, trapping and titrating the amount evolved (Johnson *et al.*, 1987). A high degree of precision and accuracy is maintained by using a computer-controlled automated dynamic headspace analyzer that extracts total carbon dioxide (C_T) from seawater using a SOMMA (Single-Operator Multiparameter Metabolic Analyzer) designed by K. Johnson of Brookhaven National Laboratory (Johnson, 1992). This apparatus is coupled to a commercial coulometer that detects the extracted CO_2 (Huffman, 1977; Lindberg and Cedergren, 1978).

The analytical system forces a sample (either seawater, Na_2CO_3 standard solution or distilled water) into a volume-calibrated pipette using a pressurized headspace gas of pure N_2 . This known sample volume (~ 30 ml) is then dispensed into a stripping chamber previously acidified with ~ 1.5 ml of phosphoric acid (the chamber and phosphoric acid are purged with pure N_2 carrier gas prior to the addition of each sample). CO_2 gas evolved from the acidified sample is then passed through a thermostated condenser (4°C) and a magnesium perchlorate trap to remove water vapor. Any acidic or reactive gases are removed by passing through activated silica gel.

The amount of CO₂ gas extracted from the acidified sample by a continuous flow of pure N₂ through the chamber is determined coulometrically by trapping and titrating the CO₂ with a DMSO based absorbent containing ethanolamine. The resulting hydroxyethylcarbamic acid which is formed with electrochemically generated hydroxide ions is titrated to maintain the absorbing solution at constant pH. Relevant chemical equations occurring in the solution are:

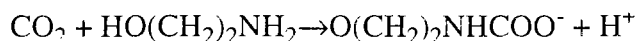

Hydroxide ions are generated by electrolysis of water at the platinum cathode and the total amount of CO₂ extracted from the sample is based on the time integrated current of the OH⁻ generated to maintain the absorbing solution at a constant, colorimetrically defined pH.

The determination of seawater total dissolved inorganic carbon is calibrated with known volumes of pure CO₂ (Johnson, 1992), a modification of the CO₂ gas loop system described by Johnson *et al.* (1985) and Johnson *et al.* (1987).

4.0 Apparatus

- 4.1 *SOMMA (Single-Operator Multi-Parameter Metabolic Analyzer)*, available from University of Rhode Island in conjunction with K. Johnson, Brookhaven National Laboratory. Includes:
 - 4.1.1 Eight port gas chromatography valve
 - 4.1.2 Two loops of stainless steel tubing of known volume
 - 4.1.3 Three thermistors accurate to ± 0.05°C
 - 4.1.4 SOMMA glassware (e.g. stripping chamber, calibrated water-jacketed pipette, water-cooled condenser, aerosol traps)
 - 4.1.5 Temperature controlled water bath circulators
 - 4.1.6 Temperature controlled sample bottle holder
- 4.2 A model 5011 CO₂ *coulometer* (UIC Inc., P.O. Box 863, Joliet, IL 60434)
 - 4.2.1 Coulometer cell (temperature controlled)
 - 4.2.2 Electrodes: platinum spiral cathode and silver rod anode
 - 4.2.3 Rubber cell top
 - 4.2.4 Stir bar

4.3 *Computer system*

4.3.1 PC (e.g. 286)

4.3.2 Printer

4.3.3 Software program (K. Johnson)

4.4 *Sampling equipment*

4.4.1 Clean 1000 ml borosilicate reagent bottles and ground-glass stoppers

4.4.2 Apiezon L grease

4.4.3 Tygon[®] drawing tube

4.4.4 Pipette to dispense mercuric chloride

4.5 *Other*: Barometer, e.g. Paroscientific transducer

5.0 **Reagents**

5.1 *Compressed gases*:

5.1.1 Carrier gas: Nitrogen (>99.9995%)

5.1.2 Calibration gas: CO₂ (>99.999%)

5.1.3 Headspace gas: Air (350 μatm CO₂)

5.2 *Phosphoric acid* (reagent grade): Phosphoric acid, diluted with deionized water by a factor of 10:1 (~8%) is used to acidify seawater samples.

5.3 *Magnesium perchlorate* (reagent grade): For the removal of water vapor.

5.4 *Activated silica gel*: For the removal of reactive acidic gases. Glass tubes (ORBO-53 traps) with activated silica are custom-made by Supelco Inc., U.S.A.

5.5 *Cathode solution*: UIC Coulometrics, Inc. proprietary mixture of water, ethanolamine, tetraethylammonium bromide, and thymolphthalein in solution in dimethyl sulfoxide (DMSO).

5.6 *Anode solution*: UIC Coulometrics, Inc. proprietary solution containing saturated potassium iodide in water and DMSO.

5.7 *Potassium iodide* (reagent grade): Added to anode solution.

- 5.8 Saturated solution of *Mercuric chloride*:
- 5.9 *Ascarite*: For the removal of CO₂ from the carrier gas.
- 5.10 *Sodium carbonate* (optional): Na₂CO₃ (99.95% pure: Alkometric standard, Fisher Scientific Co.): Six solutions are prepared for standard calibration ranging in concentration from distilled water to 500, 1000, 1500, 2000, and 2500 μmol C.kg⁻¹.

6.0 Sampling

- 6.1 Seawater sample for C_T analysis are collected in the teflon-coated Niskin bottles either on the General Oceanics rosette or individually mounted on stainless steel hydrowire. C_T seawater is collected after the first and replicate oxygen samples.
- 6.2 The samples are drawn into 12 individually numbered, clean, one liter borosilicate glass bottles. Water is also drawn into at least three duplicate bottles. In obtaining seawater samples, care is taken to minimize turbulence and to prevent the retention of air bubbles in the bottles. A 30-50 cm length of Tygon[®] tubing is connected to the Niskin bottle spout. The end of the tube is elevated before the spout is opened to prevent the trapping of bubbles in the tube. With the water flowing, the tube is placed in the bottom of the bottle. The bottle is slowly rotated and the side of the bottle tapped with the stopper to ensure that no air bubbles adhere to the bottle walls. At least two to three volumes of water are allowed to overflow from the bottle. A headspace of >1% of the bottle volume is left to allow for water expansion. 200 μl of saturated mercuric chloride is then added to the sample bottle to prevent further biological activity. The bottle neck is dried with a Kim-Wipe stick and then the bottle is sealed with an Apiezon grease ground-glass stopper, ensuring that it remains gas-tight. Rubber bands are placed around the lip of bottle and the stopper in crisscross manner as positive closure of the bottle.
- 6.3 The samples are then stored in a cool, dark location until analysis.

7.0 Procedures

- 7.1 *Bottle preparation*: Bottles should be carefully cleaned before use. Used bottles are emptied and any grease on the bottle neck is removed with kim-wipes. Bottles are thoroughly washed with a commercial detergent, then rinsed with a 10% HCl solution. Copious rinsing with deionized/distilled water is followed by an acetone rinse. The bottles are then allowed to air dry for an hour and sealed with ground-glass stoppers.
- 7.2 *Maintenance of SOMMA-Coulometer system*
- 7.2.1 The titration cell is cleaned with copious rinses of deionized water and a rinse with acetone. The sidearm of the cell is then filled with acetone which is then left to drain overnight through the frit separating the cathode compartment from

the sidearm. The cell is then rinsed with deionized water and left to dry overnight at 55°C.

- 7.2.2 The rubber top, electrodes, stir bar and perchlorate trap are thoroughly cleaned with deionized water.
- 7.2.3 The titration cell, rubber stopper, stir bar, electrodes, magnesium perchlorate glass trap, and teflon carrier gas lines are dried overnight at 55°C.
- 7.2.4 The ORBO-53 tubes and magnesium perchlorate traps are renewed with each newly prepared coulometer cell.

7.3 *Determination of the background level*

- 7.3.1 Each analysis session, fresh coulometer cell solutions are used.
- 7.3.2 An aliquot of phosphoric acid is introduced into the coulometer cell. CO₂-free N₂ carrier gas is allowed to run through the SOMMA system and into coulometer cell. Once the background titration rate is stable, a background level is determined by averaging over a 10 minute period.

7.4 *Calibration*

- 7.4.1 The electrical calibration of the coulometer is not perfectly accurate and the current efficiency of the electrode processes occurring in the coulometer cell have been shown to vary from 100% (D.O.E., 1991). It is therefore necessary to calibrate the coulometer using known volumes of pure CO₂ or with a suite of Na₂CO₃ solutions (e.g. Goyet and Hacker, 1992). The amount of C_T titrated by the coulometer is recorded by microcomputer.
- 7.4.2 Valves that operate the CO₂ calibration and sample extraction systems are controlled by microcomputer (Johnson 1992).
- 7.4.3 A stainless-steel loop of known volume is filled with pure CO₂. The loop is then flushed with carrier gas into the coulometer cell and titrated. A mean calibration factor is calculated from two different loops.
- 7.4.4 Standard concentrations of C_T ranging from 500 to 2500 μmol.C kg⁻¹ can also be prepared using distilled water and variable amounts of dried Na₂CO₃ salt (D.O.E., 1991; Goyet and Hacker, 1992). Sodium carbonate solutions are treated as if they were seawater samples. A blank standard solution (distilled water without any Na₂CO₃) is also prepared.

7.5 *Analysis of a seawater sample*

- 7.5.1 Once the background level and calibration factor have been determined satisfactorily, the coulometric system can be used to analyze seawater samples.

7.5.2 The stripping chamber is drained on any previous sample. An aliquot of phosphoric acid (~1.5 ml) is dispensed into the stripping chamber. The pipette and the silicone sample lines are flushed with a new sample. The pipette is then filled and allowed to drain into the stripping chamber. CO₂ gas evolved is transferred with carrier N₂ gas to the coulometer cell and titrated.

7.6 *Post-analysis*: The dispensing and stripping systems are cleaned by rinsing with deionized/distilled water.

8.0 Calculation and expression of results

The amount of C_T titrated by the coulometer for a seawater sample is multiplied by the calibration factor (slope of calculated vs. measured concentration), giving the seawater C_T, expressed in μmol kg⁻¹ of seawater is computed as follows:

$$C_T = \frac{N - b \cdot t}{c} \times \frac{1}{V \cdot p}$$

Where:

C	=	total dissolved inorganic carbon (μmol.kg ⁻¹)
N	=	coulometer reading in counts
b	=	background level of the system
c	=	coulometer calibration factor
t	=	time required to measure pipette
V	=	volume of seawater sample
p	=	density of seawater

9.0 Quality assurance

9.1 *Quality control*: Written instructions outlining the standard operating procedures are maintained and continually reviewed and updated. Standard operating procedures are kept within guidelines proposed by the D.O.E. CO₂ survey science team (D.O.E., 1991).

9.2 *Quality assessment*:

9.2.1 The background level is usually within 0.1 μg C min⁻¹.

9.2.2 The recovery of CO₂ compared to theory during gas calibration is maintained at better than 0.2%. The two gas loops must give the same calibration factor within 0.05% before analysis of samples begin.

- 9.2.3 Within-bottle replicate and between-bottle duplicate measurement of over 100 samples give a standard deviation of approximately $0.3 \mu\text{mol.kg}^{-1}$ and $0.5 \mu\text{mol.kg}^{-1}$ respectively, well within guidelines proposed (D.O.E., 1991).
- 9.2.4 Stable seawater reference materials, supplied by A. Dickson, are analyzed regularly. Analyses of these reference materials at BBSR are within the standard deviation of the mean reported by the Scripps Institution of Oceanography ($0.3 \mu\text{mol.kg}^{-1}$). Intercomparison exercises are also undertaken with other laboratories.

10.0 References

- D.O.E. (1991). *Handbook of methods for the analysis of the various parameters of the carbon dioxide system in seawater; version 1.0*, edited by A.G. Dickson and C. Goyet.
- Goyet, C., and Hacker, S.D. (1992). Procedure for calibration of a coulometric system used for total inorganic carbon measurements in seawater, *Marine Chemistry*, **38**, 37-51.
- Huffman, E.W.D. Jr. (1977). Performance of a new automatic carbon dioxide coulometer. *Microchemical Journal*, **22**, 567-573.
- Johnson, K.M. (1992). Single-Operator Multiparameter Metabolic Analyzer (SOMMA) for Total Carbon Dioxide (C_T) with Coulometric Detection. SOMMA Manual 1.0, January 1992, Brookhaven National Laboratory, 70 pp.
- Johnson, K.M., King, A.E., and Sieburth, J.McN. (1985). Coulometric TCO_2 analyses for marine studies: an introduction. *Marine Chemistry*, **16**, 61-82.
- Johnson, K.M., Sieburth, J.M., Williams, P.J. leB., and Brandstrom, L. (1987). Coulometric total carbon dioxide analysis for marine studies: automation and calibration. *Marine Chemistry*, **21**: 117-133.
- Lindberg, A.O., and Cedergren, A. (1978). Automatic coulometric titration with photometric endpoint detection. Part II. Coulometric determination of nanomolar amounts of carbon dioxide by non-aqueous titration. *Analytica Chimica Acta*, **96**, 327-333.
- UNESCO. (1991). Reference materials for oceanic carbon dioxide measurements. In: *Report of the Sub-panel on Standards for CO_2 Measurements of the Joint Panel on Oceanographic Tables and Standards*. Report of meeting in Acapulco, Mexico, 29-31 August 1988. UNESCO Technical Papers in Marine Science.

Chapter 8. The Determination of Nitrite, Nitrate + Nitrite, Orthophosphate and Reactive Silicate in Sea Water using Continuous Flow Analysis

1.0 Scope and field of application

The following protocol for nutrient analysis is taken from the WOCE (World Ocean Circulation Experiment) Methods Manual WHPO 91-1, "A Suggested Protocol for Continuous Flow Automated Analysis of Seawater Nutrients (Phosphate, Nitrate, Nitrite and Silicic Acid) in the WOCE Hydrographic Program and the Joint Global Ocean Flux Study" (Gordon et al. 1993).

This suggested protocol provides a description of procedures which, when implemented by a competent analytical chemist, can provide high quality measurements of the concentrations of the nutrients, silicic acid, phosphate, nitrate plus nitrite, and nitrite in seawater samples. These procedures are not necessarily the only procedures which will meet this claim. Nor are they necessarily the best procedures to use for all oceanographic studies. They have been optimized to provide data to be used in open ocean, deep water, descriptive and modelling studies. Careful adherence to the protocol and methods outlined can facilitate obtaining data which can meet U.S. WOCE specifications (U.S. WOCE Office, 1989). However, to accomplish this requires a great deal of attention to detail and scrupulous monitoring of the performance of the CFA system. Although it only addresses four of the nutrients being measured in the Joint Global Ocean Flux Studies (JGOFS) program, it can serve as a basis for these analyses in part of that program. The JGOFS program primarily addresses euphotic zone experiments and observations. But it treats deep water column issues and sediment-water situations as well. For near-surface waters the concentration ranges of the nutrients are usually much lower than in most of the WOCE study areas. By adjusting experimental parameters the methods of this Protocol can be made considerably more sensitive for the near-surface work. For JGOFS work in deeper and near-bottom waters and in the Southern Ocean these methods are quite serviceable as they are presented.

2.0 Definition

Several conventions are used for denoting the nutrients discussed here: Silicic acid, phosphate, nitrate plus nitrite, and nitrite. Although some of these conventions are more precise than the abbreviated terms used in this suggested protocol, the authors beg the readers' sympathy with the need to be concise. A glossary of terms follows:

Aerosol-22	≡	a proprietary surfactant, widely sold under this name
ASW	≡	artificial seawater
BPM	≡	bubbles per minute
Brij-35	≡	a proprietary surfactant, widely sold under this name
CFA	≡	continuous flow analysis (or analyzer)
DIW	≡	deionized water
F/C, f/c	≡	flowcell
I.D.	≡	inside diameter (in reference to pump tubing)
I/F	≡	interference filter

IPH	≡	inches per hour (1 IPH = $7.06 \times 10^{-4} \text{ cm}\cdot\text{sec}^{-1}$)
LNSW	≡	low-nutrient natural seawater
M	≡	molar (1 gram mole of solute / liter of solution) M or <u>M</u>
Nitrate	≡	dissolved reactive nitrate ion, NO_3^-
Nitrite	≡	dissolved reactive nitrite ion, NO_2^-
O.D.	≡	outside diameter (refers to glass or plastic tubing)
OSU	≡	Oregon State University
OTCR	≡	open tube cadmium reductor
Phosphate	≡	dissolved, reactive, inorganic ortho-phosphate ion, HPO_4^{2-}
psi	≡	pounds in^{-2} (1 psi = $6.895 \times 10^3 \text{ Pa}$)
Silicic acid	≡	dissolved reactive ortho-silicic acid, $\text{Si}(\text{OH})_4$. This undissociated acid is probably the most abundant species of silicic acid and its dissociation products present in seawater. Theoretically it accounts for approximately 80-90% of the silicic acid present in seawater with its first dissociation product constituting most of the remainder. A very small fraction might be present in low molecular weight polymers; however dimers, and probably, trimers are recovered by the method given.
	≠	Silicate, dissolved silica, or sometimes “silica” (Used in this sense, “silica” is not correct chemical nomenclature. Silica denotes solid SiO_2 !)
SIO-ODF	≡	Scripps Institution of Oceanography, Oceanographic Data Facility
SLS	≡	sodium lauryl sulfate, $\text{C}_{12}\text{H}_{25}\text{NaO}_4\text{S}$
μM	≡	micromolar (10^{-6} moles of solute/liter of solution)

3.0 Principle of Analysis

A Continuous Flow Analyzer (CFA) uses a multichannel peristaltic pump to mix samples and chemical reagents in a continuously flowing stream to automate colorimetric analysis. CFA's reduce technician error principally by treating samples and standards exactly alike and by precision in timing and proportioning of reagent addition. Segmenting the sample stream with air bubbles reduces mixing of adjacent samples and enhances mixing of the reagents within the sample stream. The segmented stream passes through a system of glass coils where mixing and time delays are accomplished. The sample-reagent mixture reacts chemically to produce a colored compound whose light absorbance is approximately proportional to the concentration of nutrient in the sample. Finally the absorbance is measured by a flow-through colorimeter located at the end of the flow path. The colorimeter output is an analog voltage proportional to absorbance.

A fundamental difference between manual and CFA procedures is that complete color development is not required with CFA. Since all standards and samples are pumped through the system at the same rate and in constant proportion to the color developing reagents, all samples and standards achieve virtually identical degrees of color development. This saves considerable time and is one reason for the higher speeds attainable with CFA systems.

However, this aspect can introduce errors from any factor affecting the kinetics of color development, e.g. laboratory temperature. Laboratory temperature fluctuation historically has caused serious problems with the silicic acid analysis in particular. The modification described in this protocol greatly reduces the effect of ambient laboratory temperature.

In the Oregon State University (OSU) and Scripps Institution of Oceanography - Oceanographic Data Facility (SIO-ODF) programs, the Technicon- AutoAnalyzer- II (AA-II) and Alpkem Rapid Flow Analyzer- (RFA-) systems have been used to determine the seawater concentrations of silicic acid, phosphate, nitrate + nitrite and nitrite since the early 1970's. The principles of these methods are only briefly described here. Operational details for each method are given in Section 8.

The phosphate analysis is a modification of the procedure of Bernhardt and Wilhelms (1967). Molybdic acid is added to the seawater sample to form phosphomolybdic acid which is in turn reduced to phosphomolybdous acid using hydrazine as the reductant. Heating of the sample stream is used to speed the rate of color development.

Nitrate + nitrite and nitrite are analyzed according to the method of Armstrong *et al.* (1967). At a buffered, alkaline pH the sample nitrate is reduced to nitrite in a column of copperized cadmium. The sample stream with its equivalent nitrite is treated with an acidic sulfanilamide reagent and the nitrite forms nitrous acid which reacts with the sulfanilamide to produce a diazonium ion. N-Naphthylethylene-diamine added to the sample stream then couples with the diazonium ion to produce a red azo dye. With reduction of the nitrate to nitrite, both nitrate and nitrite react and are measured; without reduction, only nitrite reacts. Thus, for the nitrite analysis no reduction is performed and the alkaline buffer is not necessary. Nitrate is computed by difference.

The silicic method is analogous to that described for phosphate. The method used is essentially that of Armstrong *et al.* (1967), wherein silicomolybdic acid is first formed from the silicic acid in the sample and added molybdic acid; then the silicomolybdic acid is reduced to silicomolybdous acid, or "molybdenum blue," using stannous chloride as the reductant. This method is quite sensitive to laboratory temperature. The method is also nonlinear at high silicate concentrations, necessitating on-line dilution of samples from deep and high latitude waters and/or correcting for the nonlinearity during data processing. The OSU choice has been to dilute high concentration samples on-line by using larger flow of a diluted molybdic acid reagent, while the ODF choice has been to correct for the nonlinearity during data processing. An adaptation of the Armstrong *et al.* method by Gordon *et al.* (in preparation) greatly reduces the effect of laboratory temperature and improves linearity. This adaptation is presented here.

4.0 Apparatus

4.1 *Continuous Flow Analyzers:* This protocol covers use of either the Technicon AutoAnalyzer -II or the newer Alpkem- RFA-300 or Alpkem RFA-2 systems. In this protocol, the abbreviation "CFA" refers to continuous flow analyzer systems including both the Technicon and Alpkem systems. "AA-II" denotes the Technicon Instruments Industrial AutoAnalyzer II systems and "RFA" denotes both the RFA-300 and RFA-2 systems collectively or separately. All operational and chemical considerations apply equally to both RFA's. The AA-II and RFA systems tested gave comparable results for the same

natural seawater samples to which known additions of nutrients had been made. This remained valid upon comparison of contemporary deep-water data obtained with the RFA systems with historical data of modern quality obtained in the same area using the AA-II. The criterion for “comparable results” is agreement within routinely achieved precision, namely the WOCE specifications for nutrient precision.

The Alpkem systems have the advantage of speed (ca. a factor of two), lower consumption rate of reagents and seawater samples (ca. a factor of four or more) and somewhat lower space requirements for the RFA-II. However the Technicon AA-II hardware is somewhat more reliable and robust and permits longer pathlengths for greater sensitivity for phosphate. Unfortunately, the longer pathlengths and more primitive flowcell designs of the AA-II add to the magnitudes of the corrections for refractive index differences between pure water and seawater.

Both lines of equipment include an automated sampler that introduces the seawater samples into the analytical system at precise intervals. It separates the samples by introducing for short periods of time a “wash” consisting of low nutrient seawater or artificial seawater having low nutrient content. The effect of the wash is to provide a low-concentration marker (generally a negative-going “spike”) between samples and between standards. It serves little useful purpose as an actual “wash” of the system.

The next major component is a peristaltic pump that simultaneously pumps samples, reagents and air bubbles through the system. The pump is the analog of the chemist who pipets reagents into samples in manual methods. The analytical “cartridges” are systems of injection fittings, helical mixing coils and heating baths. Figure 8.1 schematically illustrates the general components of a CFA.

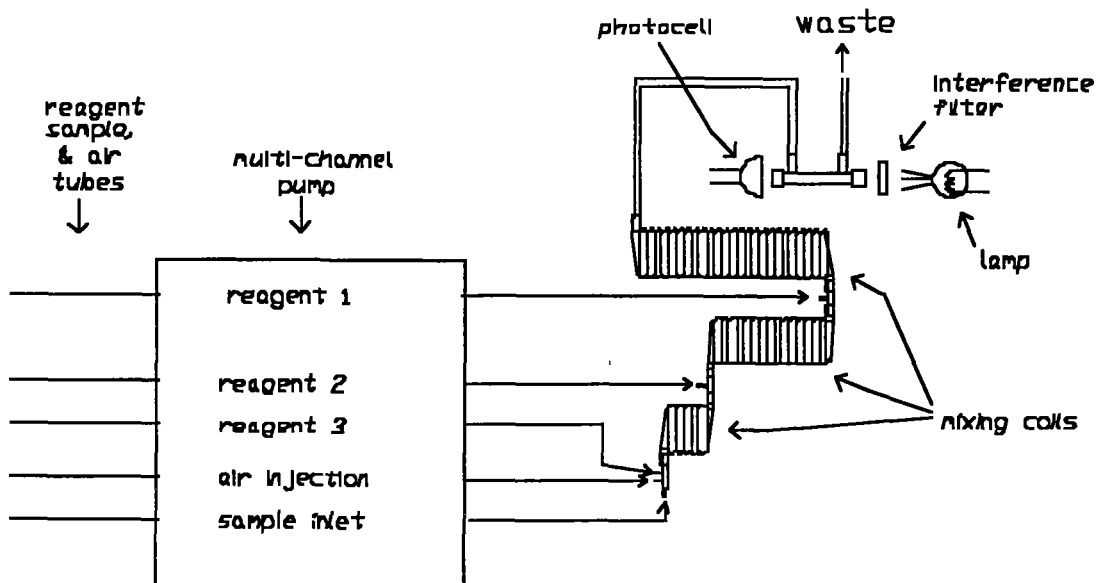

Figure 8.1. A generalized continuous flow analyzer, schematic picture.

For satisfactory results the components must be arranged with several ideas in mind. First, the pathlengths between sampler and pump, pump and analytical “cartridges,” etc. must be kept as short as possible. This is especially true of parts of the flow streams that are not segmented by air bubbles, e.g. the lines between the sample “sipper” and

the pump.¹ Otherwise excessive mixing between adjacent samples and between samples and wash water results. Second, all components should be arranged in a near horizontal plane. This is especially true of the relationships between the sample sipper tube, the flow stream “waste” outlets and the levels of reagents in the reagent reservoirs. Thus, it is not good practice to locate reagent reservoirs on shelves over the CFA, or drain waste tubes of small diameter into receptacles on the floor. The objective is to avoid large hydraulic pressure heads along the flow stream. Large hydraulic heads promote noisy output signals. A third point is to avoid “dead volumes” in the flow channels. These can be introduced by debubblers, voids in butt joints between ends of tubes, and unnecessarily large inside diameter tubing. The solutions are to avoid debubblers if not absolutely required, to cut the ends of pieces of connecting tubing square and make certain they are tightly butted together (and stay that way) and tight in their sleeves, and to use no longer connecting tubing than necessary. Voids at joints between connecting tubing and glass fittings are notorious for disrupting bubble patterns.

Regular bubble patterns are necessary for noise-free output signals. Achieving good bubble patterns primarily depends upon maintaining a clean system. Appropriate wetting agents at proper concentrations are also vitally important in most of the analyses. Excessively high temperatures of heating baths can also seriously disrupt bubble patterns.

4.2 *Volumetric Laboratory Ware:*

All volumetric glass- and plastic-ware used must be gravimetrically calibrated. Plastic volumetric flasks must be gravimetrically calibrated at the temperature of use within 2-3K. Temperature effects upon volumes contained by borosilicate glass volumetric ware are well documented and volumes at normally encountered ship and shore laboratory temperatures can easily be computed from any usual calibration temperature (e.g. Kolthoff et al., 1969; Weast, 1985).

A note about the use of glass volumetric ware and contamination of standard solutions by dissolution of the glass is in order. In response to reviewers' comments to an earlier draft of this manual the OSU group has collected data on dissolution rates of Pyrex-volumetric flasks. This group of flasks gave initial dissolution rates of 0.03 to 0.045 μM silicic acid per minute into LNSW and virtually no dissolution into DIW. Note that these data apply to the set of flasks tested and these flasks have had a varied history of prior use in the OSU laboratories. Prior leaching by acid solutions, for example might profoundly influence the dissolution rate.

Because of the marked superiority of Pyrex flasks to plastic with respect to thermal expansion and because of the very slow attack by DIW, Pyrex is recommended for preparation of the concentrated “A” and “B” standard solutions (the OSU “ABC” standard solution nomenclature is explained in Section 7). Exposure time to the Pyrex is kept to minimum. The details of use of glass and plastic ware for standard preparation are given in Section 7.

4.2.1 *Volumetric flasks.* Volumetric flasks of NIST Class A quality, or the equivalent, should be used because their nominal tolerances are 0.05% or less over the size

1. The “sipper” is a ca. 1 mm I.D. stainless steel tube that dips into the successive sample containers on the sampler tray under control of the sampler timing circuit.

ranges likely to be used in this work. Class A flasks are made of borosilicate glass and as just noted, the standard solutions are transferred to plastic bottles as quickly as possible after they are made up to volume and well mixed in order to prevent excessive dissolution of silicic acid from the glass. High quality plastic (polymethylpentene, PMP, or polypropylene) volumetric flasks must be gravimetrically calibrated and used only within 2-3K of the calibration temperature.

Plastic volumetric flasks must be of ISO class 384 tolerance. **N.B. All volumetric flasks, including Class A, must be weight calibrated before use!** Occasional calibration errors are made by manufacturers. Handbook tables make the computation of volume contained by glass flasks at various temperatures other than the calibration temperatures quite easy (e.g. Weast, 1985). Because of their larger temperature coefficients of cubical expansion and lack of tables constructed for these materials, the plastic volumetric flasks must be gravimetrically calibrated over the temperature range of intended use and used at the temperature of calibration within 2°C. The weights obtained in the calibration weighings must be corrected for the density of water and air buoyancy. **The gravimetrically calibrated volumes must be used in computing concentrations of standard solutions.** The volumes of plastic volumetric flasks calibrated in the OSU laboratory have been stable over several years' time. However, it is recommended that each volumetric flask be recalibrated once after an interval of ca. six months and annually after that in order to accumulate good replicate calibration data.

Use of uncalibrated plastic volumetric ware and lack of attention to solution temperature at the time of making up standards can lead to aggregate errors on order of three percent or even more.

- 4.2.2 *Pipets and pipettors.* All pipets should have nominal calibration tolerances of 0.1% or better. These too must be gravimetrically calibrated in order to verify and improve upon this nominal tolerance.

Up to this time two commercial pipettors have proven to provide adequate precision for WOCE nutrient work in the experience of the OSU group. The first is the U.S.-made Lab Industries Standard REPIPET- which dependably provides 0.1% precision. To achieve 0.1% accuracy the REPIPET must be gravimetrically calibrated; because its volume adjustment has been known to shift slightly it must be regularly recalibrated during and after a cruise. Considerable skill which can be attained with practice is required to achieve the 0.1% precision. Because REPIPETs employ a glass syringe they contaminate with silicic acid unless certain precautions are taken. A plastic reservoir prevents contamination from that source. Flushing the syringe three or four times by dispensing to a waste receptacle immediately before use removes contaminated solution from the syringe.

The second high precision pipettor readily available in the U.S.A. is the Eppendorf Maxipettor. Its specifications claim 0.05 to 0.1% precision and accuracy in delivery volumes ranging from 10 to 1cc, respectively. These specifications apply to use with special, "positive displacement" tips individually calibrated with a matched pipettor. The pipettors and tips must be serially numbered and correct matching maintained during use. Gravimetric calibrations performed by five analysts and technicians of varying skill levels and with four different

pipettors and dozens of tips have shown that these specifications are credible. These pipettors should nevertheless be gravimetrically calibrated by each analyst who will use them to verify accuracy for each new pipettor and set of tips and to ensure that each analysts skill with the pipettor is adequate. Because the wetted parts of the Maxipettor are plastic, contamination with silicic acid is not a problem.

There are undoubtedly other commercially available pipettors that have sufficiently high precision and accuracy for this work. However we have not certified any others as of the time of this writing. Other nominations are welcome, particularly when accompanied by qualifying data.

Volumetric, borosilicate glass transfer pipets of the Mohr type are no longer recommended for preparation of reference or calibration standards in the WOCE Hydrographic Program (WHP). There are several reasons for this. Their accuracy and precision, with the most skillful use and gravimetric calibration, do not match those of the Eppendorf Maxipettor. Under marginal conditions of sea state it becomes difficult to maintain the attention to detail in their use required for acceptable accuracy and precision. Being glass and of awkward dimensions they are susceptible to breakage. Breakage at sea makes it impossible to recalibrate them should an error in their calibration be suspected. Maxipettors appear to be remarkably insensitive to operator technique and are quite robust.

- 4.2.3 *Calibration of pipets at sea.* This is dependent upon the particular volumetric ware being used. Because their delivery volume settings can slip, REPIPETs must be calibrated once every week to ten days to detect possible changes in delivery volume. At-sea “calibration” is done by dispensing replicate deliveries into glass ampules and sealing the ampules with a oxygen-gas torch. Care must be taken not to evaporate any of the water delivered, for instance from a drop deposited in the neck of the ampule. The ampules are returned to the shore lab where the volumes delivered are weighed and the delivery volumes calculated and checked. This is done as quickly as possible after the end of the cruise.

Note that during this step it is not important that glass drawn off from the ampule neck be saved. It may be discarded. However, when the final opening, rinsing and drying of the ampules is performed after obtaining their gross weights considerable care must be taken. One must not only not lose any fragments of glass when cracking off the necks but must keep each paired broken-off neck and parent ampule together. This can be done by assigning each ampule and broken-off neck to their own numbered and tared container such as a borosilicate glass Petri dish. The opened and rinsed (DIW) ampules, necks and their Petri dishes are dried in an oven at 105-110 °C overnight, cooled to room temperature and reweighed.

- 4.3 *Other Laboratory Ware.* For the remaining laboratory ware the main requirements are convenience, scrupulous cleanliness, and guarding against exposure of either standard solutions or silicic acid reagents to contamination by glass dissolution. Unpublished results of work here at OSU and at the U.S. Geological Survey in Menlo Park, California, indicates that an effective method for cleaning and maintenance of standard and sample bottles is by use of acetone (Gordon et al., unpublished results; S.W. Hager, personal communication) or 10% HCl (Gordon et al., unpublished results). The acetone

procedure consists of rinsing once or twice with DIW to remove most dissolved salts, rinsing once with acetone, rinsing with DIW two or more times and finally storage until next use, “shaken dry” and capped. For the HCl procedure simply rinsing with the HCl followed by thorough rinsing with DIW and storage as for acetone treatment suffices. The HCl procedure avoids the fire and toxicity hazard of acetone use.

Regular cleaning of storage containers reduces variance in the analytical results, i.e., samples degenerate more slowly in well maintained bottles than in dirty ones. Similar cleaning procedures using isopropyl alcohol or DIW instead of acetone or dilute acid did not maintain low variance after storage.

5.0 Reagents

In general all reagents must be of very high purity. Terms denoting adequate purity in the U.S.A. include “C.P. (Chemically Pure) Reagent Grade,” “Analytical Grade,” “Analyzed Reagent Grade” and others.

N.B. When weighing and packaging “preweighed” reagents or “preweighs” for work at sea it is imperative that the label of each preweighed container contain the name of the manufacturer and lot number from the label of the original container. Further, when making up the actual reagent solutions, it is imperative that all of the information contained on the label of the preweighed package be copied into the laboratory notebook. The analyst must also note the time and date of reagent preparation and the time and date when its use is begun. Such information can be invaluable for tracing sources of problems arising from “bad batches” of reagents or improperly formulated or weighed reagents.

Special considerations apply for chemical reagents to be used for standard materials because some candidate materials are not available in sufficient or known purity or they may be unstable with time. For example, assays of nitrite salts given by reagent manufacturers are commonly in the range of 95-96%. The assays are often given to 0.1% but the figure is really a minimum guaranteed value and not necessarily precise or accurate; nitrites are unstable salts. Fortunately, nitrite concentrations in the oceans are generally low and the required analytical precision is usually only on order of 2-5% of water column maxima at best. When an assay is given on the reagent bottle one may use that value to adjust the weights taken. Reported nitrite concentrations using this procedure therefore might be biased by ca. one percent, a figure we regard as acceptable for nitrite. If one could assure that the reduction efficiency of the cadmium reductor of the nitrate channel were nearly 100%, the nitrite assay could be checked by passing the nitrite standard through the nitrate channel. Unfortunately, the efficiency of the cadmium reductor is usually checked by comparing the responses of the nitrate channel to nitrite and to nitrate standards, making this difficult. Note that no precision or accuracy specification has been adopted for nitrite concentration in the U.S. WOCE hydrographic program (U.S. WOCE Office, 1989, p.30).

In the WOCE Hydrographic Program the objective for silicic acid precision is much stricter. Although the specified objective is only 3% precision and accuracy, several laboratories routinely achieve short-term, within-laboratory precision of a few tenths percent (Weiss et al., 1983). Hence it would seem desirable to achieve accuracy in preparation of standards to this level. The goal of the protocols and methods set forth in this Suggested Protocol is on order of 0.1% for accuracy and precision of standard preparation. Even though sodium

fluosilicate is a convenient and reproducible material for producing working standards to calibrate the CFA, it is not available in sufficient purity to function as a calibration standard on its own. Individual batches from the same or different manufacturers differ in equivalent silicic acid content by as much as 3% or more. Therefore, although fluorosilicate may be used as a routine calibration standard, its composition must be assayed by comparison with standards prepared by fusion of very pure silicon dioxide.

Sufficient replicate comparisons of pure silicon dioxide (SiO_2) with replicate standards prepared from sodium fluorosilicate must be made to assure adequate confidence in the assay. Extremely high purity SiO_2 is available from suppliers to the semiconductor industry; more than 99.9% purity is readily available at modest cost. (It must be dried by ignition at high temperature following manufacturers' specifications in order to meet this purity criterion.)

A suitable procedure is given by Kolthoff et al. (1969, p. 651). This procedure is followed as far as the dissolution of the fusion cake. At that point the solution is diluted to a precise volume and a suitable aliquot is diluted to a working concentration. This concentration should be similar to that of a fluorosilicate working standard made from the fluorosilicate reagent to be assayed. Finally, the solutions are compared using the method given in this Protocol. Once a bottle of silicofluoride has been so assayed it may be used for years if care is taken to prevent contamination. **N.B.** At the outset of the assay process the fluorosilicate should be mixed thoroughly using a scrupulously clean metal spatula to assure homogeneity.

5.1 *Deionized Water.*

Dependable, pure water is an absolute necessity for the nutrient work. It may be double distilled water (DDW) or deionized water (DIW). In the case of DDW, the analyst must be careful to avoid contamination with silicic acid from dissolution of quartz or glass stills, connecting tubing or reservoirs. There are several high quality, commercially available systems that consistently deliver high purity DIW having 18.0 Megohm-cm specific resistance or better (American Society for Testing and Materials, or ASTM, Type I). These systems generally employ four steps including a prefilter, a high capacity resin cartridge and two tandem, ultrahigh purity, mixed-bed cartridges. This water suffices for preparation of reagents, higher concentration standards and for measurement of reagent and system blanks.

To be certain of an adequate supply of DIW or DDW at installation time in the ship-board laboratory it may be necessary to obtain reliable DIW or DDW supply from a local laboratory or vendor, perhaps 50 l or more. This supply may have to last through the first few days at sea while purer water from the ship's evaporator (distilling system) flushes shore water out of ship's storage tanks. In port water supplies are notoriously impure and can rapidly exhaust the very expensive cartridges in a demineralizer system. Furthermore, the high concentrations of silicic acid present in many coastal fresh waters cause some silicic acid to pass through many commercial water purification systems. Often it is best to obtain feed water for the laboratory deionizer system directly from the ship's evaporator if possible. The analyst must check the water immediately for possible contamination by phosphate and/or silicic acid. These are common ingredients in formulations for cleaning and eliminating boiler scale in evaporators.

5.2 *Low-Nutrient Seawater (LNSW)*: Final, working, or calibration standards are best prepared using natural seawater of low nutrient content as the matrix. Given the complex composition of seawater, there are manifold possibilities of interferences by exotic constituents. An inherently dependable way of compensating such errors is to make the working standards in a matrix as close in composition to the unknown samples as possible. Fortunately, low nutrient seawater is abundantly available in open ocean, central gyres in the late spring and summer. Ideally, it should be collected and filtered through a filter having a pore size of 10 μm or smaller and then be stored in the dark for several months to stabilize. Filtration and storage are not absolutely necessary, but more consistent day-to-day results will result from use of filtered and aged seawater. The accuracy and precision of working standards will not suffer markedly using fresh, unfiltered seawater if the time between preparation and use of the standards is kept short, less than two or three hours, to avoid significant change. The nitrate and silicic acid concentrations of the LNSW should be less than ca. 5 μM to avoid driving the total concentrations of these nutrients significantly out of the concentration range for which the nonlinearity has been measured.

6.0 Sampling

Two factors dictate nutrient sampling procedures; the range of concentrations of nutrients present in the oceans, from extremely low to only moderate concentrations, and the biochemical and chemical reactivity of the nutrients present in seawater.

The extremely low concentrations present in oligotrophic surface waters of central gyres in spring and summer can be contaminated seriously during sampling and sample storage. Microbial films form on sampler and sample bottle walls in very short times, hours to a few days. Such films can take up or release nutrients significantly.

The nutrients vary widely in biochemical and *in vitro* reactivity. Nitrite and phosphate are the most labile while silicic acid appears to be the least reactive. Nitrite concentrations in seawater samples and standard solutions often change markedly in a few hours under common storage conditions. Yet silicic acid samples and standards can often be stored at room temperature (in the dark) for days with little detectable change.

At the beginning of every cruise leg and at approximately weekly intervals or more often if indicated, the water samplers (usually 10L Niskin samplers in the WHP) must be inspected for evidence of biological or inorganic films on the interior walls, valves or end caps. A powerful flashlight or work light is necessary for this. Watch especially for iron rust staining on walls near the points where sampler handles are installed and on the end caps where coatings on springs may have worn through allowing the spring to corrode. If present the rust stains must be removed with 8M, or stronger, HCl. Springs whose coatings have worn through must be replaced and any other sources of rust must be eliminated or adequately protected from corrosion. Check with the hydrographic technicians for components and assistance. Accumulated microbial films should be removed using suitable brushes, scouring agents and detergent solutions. The scouring agents and/or detergents used must be checked to be certain they are nutrient-free.

6.1 *Nutrient Sample Containers.*

These may be made of any of several plastics. Glass of any kind including “resistance glass” or “borosilicate glass” is not acceptable. Any glass contaminates the samples with silicic acid by easily measurable dissolution. 30cc (1oz.) high density polyethylene or polypropylene small mouth bottles (“Boston Rounds”) serve very well. These bottles, when filled ca. 2/3 full, contain ample water for either the AA-II or the RFA. Many laboratories have shown these bottle materials to be acceptable; they neither add nor remove nutrients from seawater samples. Before using them for the first time they are easily cleaned with warm detergent solutions but again, one must avoid nutrient-containing detergents. Some workers find 50cc screw-capped, plastic centrifuge tubes more useful. The particular plastics in these tubes should be checked for possible interferences such as adsorption of phosphate from the samples.

The sample bottles or other containers must be cleaned frequently to prevent nutrient uptake or release from microorganisms that colonize the inside surfaces. Experiments were conducted at sea, aimed at reducing variance in the data that arise from this source particularly if samples have to be held for a time before analysis, with or without refrigeration. Cleaning at least once every four days with acetone or dilute acid following a procedure such as that in Section 4.3 significantly reduced variance in replicate samples. The experiments also showed that rinsing with DIW or isopropanol is not effective in stopping the activities of these microorganisms.

After cleaning the bottles may be stored filled with DIW or shaken nearly dry and stored in that condition. They must not be stored filled or partially filled with seawater! At the very least the seawater remaining after analysis should be poured out and the bottles shaken dry.

6.2 *Sampling Order, Procedure and Precautions.*

In the WOCE Hydrographic Program the nutrient samples are to be drawn immediately following the tritium samples and just before the salinity samples for CTD calibration (Joyce et al., 1991) making them the ninth set of samples drawn. In general, drawing the nutrient subsamples immediately after the samplers arrive on deck is not critically important. It is certainly less so than for some of the dissolved gases (e.g. dissolved oxygen, CFC's and other trace gases such as nitrous oxide and carbon monoxide). The nutrients should be sampled before the tritium samples if possible. This can save up to one hour of nutrient decomposition time. In any case, the analyst should not waste any more time at this stage than is necessary especially because perhaps an hour will have already been lost while the other preceding samples have been drawn. One should try to keep the interval between arrival on deck and start of analysis to less than an hour and a half if possible. When no other gas or tracer samples than dissolved oxygen are to be taken, the nutrients immediately follow oxygen sampling. When practical, preliminary start-up of the CFA should be done before actually beginning the nutrient sampling in order to keep the delays to a minimum.

The sampling procedure is important. Sample containers must be rinsed three times with approximately 10-15cc of sample, shaking with the cap loosely in place after drawing each rinse. Pour the rinse water into the cap to dissolve and rinse away any salt

crusts remaining from earlier sampling and trapped in the threads of the cap. Finally, fill the sample container ca. 2/3 to 3/4 full and screw the cap on firmly.

During sampling care must be taken not to contaminate the nutrient samples with fingerprints. Fingerprints contain measurable amounts of phosphate. Thus one should not handle the end of the sample draw tube, touch the inside of the sample bottle cap or any place on the sample bottle neck. Another point to watch while sampling is not to let the nutrient samples be contaminated with seawater, rainwater or other spurious material dripping off the rosette or water samplers.

Immediately upon completion of the nutrient sampling take the samples to the analytical laboratory and begin the analyses as quickly as possible. Again, if possible, have the CFA running with reagents flowing before going to collect the samples. Often the preliminary blank and standard sequences can be programmed into the analyzer during waiting periods while sampling. In a series of observations, phosphate concentrations changed by 0.005 $\mu\text{M/hr}$ for Antarctic waters while sitting in the sampler tubes on the analyzer sampler (Gordon and Dickinson, unpublished data).

6.3 *Sample Storage.*

Nutrient samples must be analyzed immediately after sampling if at all possible!

The only exception is if the CFA is not functioning correctly. Refrigeration of nutrient samples is not effective for more than an hour or two. Refrigerator temperatures are not low enough to stop growth of many marine organisms, those which grow optimally at typical deep-sea temperatures of 1-4°C. To be sure, growth is slower at lower temperatures but it is in general not stopped. This problem may or may not appear with some water samples from particular regions of the oceans and with varying degrees of cleanliness of the nutrient sample bottles. There has not been a great deal of quantitative data published on this subject (but see Gilmartin, 1967; Grasshoff *et al.*, 1983; Macdonald *et al.*, 1986; Chapman and Mostert, 1990). However most analysts agree that whenever possible natural seawater samples should be analyzed for nutrients as quickly as possible after collection. Sample storage is to be avoided in the WOCE hydrographic program where accuracy and precision are of highest priority (Group of Technical Experts on Nutrient Analysis, 1988).

As a last resort, if the CFA is not operable and it appears that it can be repaired within less than eight or perhaps up to 12 hours, the samples can be refrigerated in the dark at 4 °C or less. Should this happen, it must be noted in the laboratory notebook and/or on the sample log sheets. In general, the resulting variance and accuracy will suffer.

If longer storage is necessary samples should be frozen as soon after collection and as rapidly as possible. Before freezing ensure that no sample bottles are filled more than 3/4 full and all caps are firmly screwed on because loss of brine can cause extreme systematic errors. If a freezer is used, it should be a deep freezer ($t \leq -20^\circ\text{C}$). Good air circulation around the bottles in the freezer is important. An open wire rack is preferable to wooden trays. Ensure that the sample bottles remain upright while freezing and while in storage. Again, loss of unfrozen brine will be fatal to good results. Errors on order of 100% can result! Often, when a low temperature freezer is not available, a better freezing method is to use an ice-salt bath and later to transfer the samples to the storage freezer. Another expedient is to use an anti-freeze solution in a bath in the ordinary freezer to improve heat transfer rates during the freezing step. Nutrient samples contin-

uously degrade during frozen storage. Analyze them as soon as possible. Keep a maximum-minimum recording thermometer in the storage freezer to detect otherwise unnoticed, thawing temperatures that might occur before analysis. As a final note, samples should be frozen only as a last resort, when they cannot be analyzed within 8-10 hours of collection.

Important: To thaw frozen samples for analysis use a tepid water bath (ca. 40°C) and thaw the samples in less than 15 minutes; no more at a time than can be accommodated by the CFA, perhaps 5-10 at a time. A running (cold) water bath is also satisfactory if the samples can be thawed within 15 minutes. In either case take care not to contaminate the samples with the water used for thawing; make certain the caps are screwed on firmly and try to keep the bottles upright with the caps above the water line in the bath. Also important—be certain to mix the samples thoroughly after thawing in order to mix the supernatant, fresher water completely with the concentrated, underlying brine that was formed by the freezing. Otherwise, errors can exceed 300% depending upon vagaries of geometry of the CFA sampler, ship motion and other conditions.

If silicic acid concentrations exceed ca. 40 μ M the samples will have to be saved after the first pass through the CFA and re-analyzed after standing for 24 hr. Silicic acid numbers will be biased low for the first pass. Store the samples in the dark at room temperature to allow polymerized silicic acid to depolymerize. Then, mix the samples thoroughly again before analysis.

7.0 Procedures and Standardization:

7.1 Calibration Protocol.

This protocol is designed for calibration of the continuous flow analyzer (CFA) systems to be used for nutrient analyses in WOCE and JGOFS. It assumes that working standard solutions for calibration of the analyzers will be prepared by dissolution at sea of pure, crystalline standard materials, pre-weighed ashore, followed by dilution to appropriate, working concentrations (described in Sections 7.2-7.4). Efforts have been made in the OSU laboratory to prepare stable working calibration standards at oceanic concentrations that can be prepared ashore prior to an expedition, shipped to the expedition ports and stored with integrity for several months. These efforts have not been successful. Therefore this protocol continues the scheme of preweighing and packaging the dry, crystalline standard materials and making the working standard solutions at sea.

The procedure given here consists of first preparing a set of "A" standards using precisely weighed (to ± 0.1 mg) primary standard materials (phosphate, nitrate, nitrite) dissolved in DIW and made up to accurately known volumes. The weights taken must be corrected to *in vacuo*. The nominal weights given here for standard preparation are **NOT** *in vacuo* weights. The correction is approximately 0.1%. The buoyancy correction should be calculated for the laboratory conditions of atmospheric pressure, temperature and humidity occurring at a given institution. It will be essentially constant and one value for the correction factor can probably be used at all times. However, this should be checked for each set of laboratory conditions. For all WOCE work and deep-water work in JGOFS, standard concentrations must be calculated for the exact weights taken, not the nominal weights.

Nitrite A standards are made separately but phosphate and nitrate may be made up as a single, mixed A standard. A "B" standard is next prepared by dissolving a preweighed silicic acid standard material in DIW, adding an aliquot of mixed or aliquots of single phosphate and nitrate A standard(s) and making the solution up to an accurately known volume. Finally, an aliquot of the B standard together with an aliquot of the nitrite A standard is added and the solution is made up to working, calibration-standard concentrations, or "C" standards, at typical, oceanic concentrations using LNSW. The working standards are thus mixed standards containing all four nutrients. Note that whether or not nitrite is present in the mixed standard appreciable systematic errors in the nitrate results can occur under certain conditions. These conditions are discussed in the section on nitrate analysis.

The proportions of the different nutrients in the standards may need to be adjusted to approximate ca. $80 \pm 10\%$ of their maximum concentrations in the ocean basin to be studied. This may be done by adjusting the weights of primary standard materials taken or the volumes of A standards pipetted into the B or working C standards, as appropriate. The proportions to be used must be decided before beginning a cruise leg and not changed during the leg.

To summarize the standard solution nomenclature:

A standard: stock standard solution containing primary standard nitrate, phosphate, or nitrite prepared in DIW. It may contain both nitrate and phosphate.

B standard: stock standard solution containing aliquots of the phosphate and nitrate A standards plus the primary standard for silicic acid (also prepared in DIW).

C standard: the calibration standard or working standard that is actually introduced into the analyzer for calibration (prepared in low-nutrient seawater).

The timing and frequency of standard preparations, comparisons and analyzer calibrations given here represent minimum guidelines. Individual laboratories and analysts may have more stringent protocols that will match or improve the accuracy and precision of their work beyond that attainable with these minimum guidelines. Other protocols are acceptable only insofar as they result in achieving the WOCE and JGOFS specifications of precision and accuracy. The protocols given here, if carefully followed, will assure achievement of the WOCE and JGOFS specifications.

N.B. It is imperative the analyst keep a complete and detailed record in the laboratory notebook of all pipet, pipet tip and volumetric flask identities used for preparation of each standard. Further, the label information for each preweighed standard used must also be recorded in the notebook. Record the date and time of preparation and date and time placed in use.

7.1.1 *Scheduling of preparation of A standards.*

Prepare three sets of A standards at the beginning of a cruise or cruise leg. One will be used for preparation of working, calibration standards. The others will be used for preparation of reference standards to be used to check the integrity of the working A standard. Whenever possible, the first check should be carried out before the first station of the cruise or leg and certainly before the end of the first week. The absorbances of working standards prepared from the A standards must agree within 0.2, 0.3 and 0.4% for silicic acid, nitrate and phosphate, respectively. Nitrite must agree within an absorbance difference corresponding to 0.05 μM . If the standards do not agree within these specifications, a fourth A standard is to be prepared and another check conducted immediately. Usually the standard will agree within specifications with two of the first three and any of them may be used to prepare the working standards. If not, a fifth must be prepared, checked and the preparations repeated until satisfactory results are obtained. If this requires more than three preparations something is likely to be seriously wrong with homogeneity of the standard reagent material, the weighings or the volumetric work. Any wildly discordant A standard preparations may be discarded after complete and appropriate notes have been entered in the field notebook. Thus, a sufficient number of dark, plastic storage bottles must be provided to save up to four A standards.

Retain all concordant A standard preparations throughout a cruise leg, or until used up. Prepare a fresh A standard at least once a month and immediately check against the previously prepared standards. If possible, the working A standards should be compared with an A check standard once per week, the comparison data processed and examined that day and results of the comparison noted in the seagoing lab notebook.

7.1.2 *Scheduling of preparation of B standards:* Prepare B standards at least once per week. This frequency must be monitored for the particular shipboard laboratory conditions by following this scheduling protocol. More frequent checking may

be necessary under some conditions. Lack of agreement within the specifications noted earlier is an indication that more frequent comparisons are required. Note that each B standard preparation requires a new, preweighed silicic acid standard. Provision must be made for a sufficient number of B standard preparations to meet the worst-case number of preparations for the duration of the cruise.

7.1.3 *Scheduling of preparation of C standards:* These are, in general, stable for no longer than four to six hours. They must be prepared just before each station unless the stations are separated by no more than three hours. Lack of agreement between results from deep water samples from adjacent stations may indicate storage of working, calibration standards for too long.

7.1.4 *Frequency of calibration of the nutrient analyzer.*

The drifts of the nutrient analyzer sensitivities for all the methods, colorimeters and laboratory conditions checked at OSU appear almost always to be monotonic and approximately linear with time. This seems valid for periods of about one to one and a half hours, approximately the time required to analyze one station's set of samples. It also assumes use of the low temperature drift modification of the silicic acid method described here (Gordon et al., in preparation).

Therefore the protocol presented here consists of running a complete set of reagent blank (DIW) samples, working standard matrix (MAT) and upscale concentration (STD) calibration standards only at the beginning and end of each station's set of samples. If the time lapse between standard sets exceeds one and a half hours, sample degradation can become a problem. Possible remedies include dividing the samples into batches with standards and blanks at beginning and end of each, or the station sample sequence can be interrupted to allow a mid- batch standard and blank set. If the OSU nutrient data processing software is being used, it must be modified to correctly process the data. At present it cannot handle mid-batch standards and blanks.

7.1.5 *Linearity ("Beer's Law") checks.*

Although all of the analytical methods described in this Suggested Protocol are sufficiently linear for the WHP (when corrected as necessary), linearity must be checked at the beginning of the cruise or leg, before any samples are analyzed. The checks must be repeated once a week thereafter and again at the very end of the station work, just after or together with the last station's samples. There are several reasons for this. One is that performing a linearity check provides a good test of system performance. It helps assure that all of analytical parameters are correctly set up. The data from the first linearity test can be used to evaluate the "carryover correction" for each channel, an excellent quality control check. If the data originating group chooses this approach the linearity data are used to correct for nonlinearity. This approach won't be discussed here. Perhaps most importantly, if an operating parameter has inadvertently been changed, thereby making a method excessively nonlinear, the existence of the nonlinearity measurements permits post-cruise correction.

All of the methods presented here are linear within experimental error on averaging of several linearity checks. This should be true with a mid-scale offset

from a straight line of less than 0.2%. If not, something is wrong and troubleshooting must be started before any samples (or any more samples) are analyzed. For the previous CFA methods for silicic acid from ca. 1973 to the present there was a mid-scale non-linearity of ca. 0.4 to 0.7%. This is a sensitive function of the extent of dilution of the sample to acceptable, maximal concentrations. The new silicic acid method described in this Suggested Protocol, optimized to reduce lab temperature sensitivity, also meets this nonlinearity specification.

7.2 *Materials for Preparation of Calibration Standards, General Considerations.*

We now give a detailed set of instructions for preparation of the working, or calibration standards. The reference A standards to be used for checking the working A standards are prepared according to the same instructions and using the same high-accuracy volumetric techniques as for the calibration standards. Again, the working, or calibration, standards are used for calibrating the CFA; the reference A standards are used for checking the integrity of the calibration standards.

7.2.1 *The primary standard materials:* These must be chemically pure, reagent grade or primary standard grade chemicals, crushed and dried at 105°C for ≥ 2 hours and stored in a desiccator over BaO or MgSO₄ (P₂O₅ also may be used but with care to avoid contamination). **NB.** The chemicals are finely **crushed** using a carefully cleaned mortar and pestle; they must not be **ground**! There is a difference.¹ Again, weights must be corrected to *in vacuo* in order to achieve 0.1% accuracy which is desirable given the reproducibility attainable with CFA. The weights given below are nominal. If, for efficiency, exact weights are not taken, careful track must be kept of the exact weights placed in each “preweighed” container, air buoyancy corrections made, and actual concentrations used in subsequent computations of concentrations.

7.2.2 *Deionized water (DIW):* This is prepared by passing fresh water through two or more research grade, mixed-bed, ion exchange columns. See Section 5.1 for more details on commercially available systems capable of producing acceptable deionized water.

7.2.3 *Artificial seawater (ASW).*

ASW of salinity ca. 34.7 is prepared by dissolving 128.5 g sodium chloride (NaCl); 28.5 g magnesium sulfate heptahydrate (MgSO₄·7H₂O); and 0.672 g sodium bicarbonate (NaHCO₃) in four liters of DIW. These reagents must be high quality reagent grade, to avoid excessive nutrient or trace metal contamination. ASW is used for wash solution between seawater samples and in an emer-

1. Crushing is accomplished with use of minimum force, rocking the pestle back and forth over a small amount of the material to be crushed. Grinding is defined here as a vigorous circular movement of the pestle against the mortar, with maximum or strong force. Grinding can impart considerable energy to the material being ground, sufficient to cause chemical change in some cases. The need for crushing is to fracture coarsely crystalline material into a rather fine, fairly uniform powder so that water trapped in coarse crystals can evaporate during the drying process.

gency for making up the C standards (and, in that case, it also substitutes for the LNSW).

Some laboratories have been more or less successful in making “zero nutrient” artificial seawater for measuring reagent blanks. Usually the constituent salts are too contaminated with nutrients to make this feasible, particularly with respect to phosphate and silicic acid. With the advent of commercially ultra-high purity materials this might now be possible. If so it would be nice to have an artificial seawater of essentially zero nutrient concentration with which to measure reagent blanks without having to worry about refraction errors.

There appear to be two drawbacks to this approach but it should be pursued. First, it is likely to be quite expensive to make ASW in the necessary quantities. Second, it is possible that interfering substances in natural seawater but not present in the usual recipes for ASW might be quantitatively significant. This places a burden of responsibility upon a laboratory using that approach to guard carefully against this possibility.

- 7.2.4 *Low-nutrient seawater (LNSW)*: Natural seawater containing low concentrations of nutrients should be filtered upon collection and stored in the dark for three or four months to stabilize (see Section 5.2). This water is used for preparation of the C standards. It need not contain “zero” nutrient concentrations because it is **not** used for reagent blank measurements. Also, it is usually too precious to be used for “baseline checks.” OSU requirements are usually ca. 100L for a typical one-month WOCE-type expedition leg.
- 7.2.5 *Volumetric glassware*: For reagent preparation it is not necessary to calibrate the volumetric ware used. For standard preparation it must be gravimetrically calibrated! (See Section 4.2)

7.3 Preparation of A Standards.

- 7.3.1 *Phosphate and nitrate A standards*: 2,500 μM HPO_4^{-2} and 37,500 μM NO_3^- . Quantitatively transfer 0.3402 g potassium di-hydrogen phosphate (KH_2PO_4) and 3.7912 g potassium nitrate (KNO_3) to a calibrated 1000 ml volumetric flask and dissolve in DIW, bring exactly to the mark with DIW. If using a gravimetrically calibrated plastic volumetric flask, the temperature of the DIW must be within 2°C of its calibration temperature. This A standard may be made up as two individual phosphate and nitrate solutions with subsequent aliquots in Table 8.1 adjusted accordingly.
- 7.3.2 *Nitrite A standard*: 2,000 μM NO_2^- . In a 1000 ml volumetric flask dissolve 0.1380 g sodium nitrite (NaNO_2) in DIW and dilute exactly to the mark with DIW. Pure NaNO_2 is difficult to obtain; one should check the manufacturer's assay (e.g. Kolthoff et al., 1969, p. 821). The typical purities of 97-98% are usually adequate for oceanographic purposes (see Section 5.0).

- 7.4 *B Standard*: 2500 μM in silicic acid, 50 μM in phosphate, 750 μM in nitrate.
- 7.4.1 Quantitatively transfer 0.4701 g sodium silicofluoride (Na_2SiF_6) to a 1000 ml polypropylene or PMP Erlenmeyer flask containing ca. 800 ml of DIW, cover with plastic film and dissolve on an electric reciprocating shaker at moderate speed. Alternatively, the solution can be stirred with a shaft stirrer using a plastic stirrer. Complete dissolution usually requires 2-24 hours. Gentle warming can be used to speed dissolution of the fluorosilicate. Again, note that sodium fluorosilicate cannot easily be obtained in purities greater than 99%. Hence it must be assayed against pure SiO_2 (available in ultra-high purity grades, see Section 5.0).
- 7.4.2 Inspect the solution for undissolved material and record the observation in the notebook. Quantitatively transfer the solution to a 1000 ml Pyrex volumetric flask. Add: 20ml $\text{HPO}_4^{-2} + \text{NO}_3^-$ mixed A standard or 20 ml each of the separate HPO_4^{-2} NO_3^- A standards if so formulated. The actual 20 ml volumes dispensed must be known to ± 0.02 ml.
- 7.4.3 Dilute to the 1000 ml mark exactly with DIW. Mix thoroughly.
- 7.4.4 Store in a polyethylene bottle previously well-rinsed with acetone, DIW, then with three 15-20 ml portions of this B standard. Do not forget to rinse the bottle cap also.

Table 8.1 Concentrations of nutrients in the B standard

HPO_4^{-2}	50 μM
NO_3^-	750 μM
NO_2^-	0 μM
$\text{Si}(\text{OH})_4$	2,500 μM

- 7.4.5 *B Matrix Solution*: Save approximately 500 ml of the DIW used for preparation of the B standard and store as for B standard. This solution is taken as the "MAT" in the third column of Table 8.2.

- 7.5 *Working Standards*: Of various nominal concentrations.

Nominal concentrations, given in Table 8.2, are obtained by diluting the given volumes of B standard and Secondary Matrix Solution to 500 ml with LNSW. These proportions between nutrient concentrations have been found convenient for Pacific and Antarctic work. As noted earlier, they may be, and should be, adjusted for other ocean basins. This may be done by adjusting weights of solid primary standard materials and/or the volumes of aliquots taken at suitable points in the preparations.

All working standard concentrations are nominal and must be corrected according to the gravimetrically calibrated volumes contained by all the volumetric flasks and deliveries of all the pipets employed, corrected to the temperatures at which the flasks and pipets are used. For the best work, the calibrations must be checked before and after each cruise and no less often than every six months.

Possible changes in nutrient concentrations of the B standard over time must be monitored by comparing freshly prepared B standard with B standard that has been stored one day or more. In general, HPO_4^{-2} , NO_3^- and Si(OH)_4 concentrations are stable for several days in the B standard (if NO_2^- and/or NH_3 were also present in the B standard formulation their concentrations commonly would change appreciably after only 1 or 2 days). However, this is only a guideline. The B standards must be monitored and the guideline confirmed or adjusted for each expedition because the stability of the B standard may change as a function of the particular conditions prevailing during any given time.

Table 8.2: calibration standard recipes and concentrations

STD NO.	Volume (cc)			Concentration added (μmol)				
	B STD	MAT	$\text{NO}_2\text{-A}$	HPO_4^{-2}	NO_3^-	$\text{NO}_3^- + \text{NO}_2^-$	NO_2^-	SiO_2
0 (LNSW)	0	30	0.00	0.0	0.0	0.0	0.0	0.0
1	5	25	0.05	0.5	7.5	7.7	0.2	25.0
2	10	20	0.10	1.0	15.0	15.4	0.4	50.0
3	15	15	0.15	1.5	22.5	23.1	0.6	75.0
4	20	10	0.20	2.0	30.0	30.8	0.8	100.0
5	25	5	0.25	2.5	37.5	38.5	1.0	125.0
6	30	0	0.30	3.0	45.0	46.2	1.2	150.0

8.0 Analytical Methods

This section presents the details of each of the analytical methods for use with either the AA-II or RFA systems. The chemistry of the methods is the same for each. Of course the pump tube volumes and details of plumbing will differ. Flow schematics, reagent formulations and special notes where appropriate are given for both systems.

The reader will observe that analytical wavelengths for the analyses in general differ somewhat for the AA-II and RFA methods. This is mainly historical, having to do with availability of interference filters at optimum wavelengths in the early years. In some cases it was the result of the wavelengths having been specified by previous authors or by the instrument vendors. The wavelengths given here are all satisfactory if not always maximally optimum. To assure optimal wavelength selection, it is good analytical practice to measure the absorption spectrum of the colored species for each analysis as produced by the particular method used. This is done by collecting the effluent from the flowcell, preferably directly into

a microflowcell, and measuring the spectrum as quickly as possible. Modern, linear diode array spectrophotometers help immensely in this regard. It is also good technique to regularly measure the band pass spectrum of each and every interference filter to be used in all of the analyses; this includes measurement of the spare filters as well. The interlayer metal films of interference filters are subject to corrosion with resultant loss of transmission and widening of bandwidth.

In order to maintain regular bubble patterns, necessary for clean signals, the flow channels must be frequently cleaned. This should be done at least daily using 1.2M HCl followed by thorough rinsing by flowing DIW through all reagent and sample tubes. Occasional washes with 2.5M NaOH are very helpful. Care must be taken to have thoroughly flushed reagents out of their tubes and out of the system before the acid or base wash. Some of the reagents will precipitate or decompose in strong acid or base solutions and cause minor to major havoc in the system tubing. Related to cleanliness and regular bubble patterns is the issue of wetting agents (surfactants). Consistency in use of particular wetting agents is an important consideration for long term consistency in results. Substitution of one surfactant for another without careful checking on many analytical factors is dangerous. If bubble patterns break up it is often wiser to clean the system rather than trying to add more wetting agent or change to another, especially at sea.

NB. When preparing reagents is imperative that the analyst carefully record all of the label information for all preweighed reagents in the laboratory notebook. The analyst must also record the date and time of preparation, her or his initials as preparer and when each new batch of reagent is placed in use. At the beginning of the expedition leg the analyst should enter his or her full name and initials to be used to annotate each reagent preparation and the time of coming on watch.

8.1 *Phosphate:*

The phosphate method is a modification of the procedure of Bernhardt and Wilhelms (1967) employing hydrazine as the reductant. This method provides ca. 15% increased sensitivity over the ascorbic acid method often used and at the same time seems to reduce coating of the flowcell window. Because of reduced flowcell coating it also exhibits less drift than does the stannous chloride method previously reported (Hager et al., 1968). Slow coating of the flowcell windows does occur with hydrazine over a period of a few weeks. The coating can be removed by treatment with 5.4 M (30%) sulfuric acid approximately once a week.

The manifolds for the analysis are shown in Figure 8.2. For the AA-II a 5cm flowcell and Technicon- wide range S-1 phototubes (also designated as CE-25V) are used. Historically, 830 nm interference filters were used but because the absorbance maximum is rather broad, 820 nm is equally acceptable. 820 nm is routinely used with the RFA. This phosphate method characteristically exhibits a linear response up to 5.0 μM HPO_4^{2-} with a worst-case deviation from a linear regression through the Beers-Law check data of less than 0.1% of full scale. This was the highest concentration tested. At the wavelengths indicated the analytical sensitivity is 0.071 AU/ μM phosphate in the seawater

sample stream. Maximum absorbance for the highest open ocean concentrations is ca. 0.25 AU.

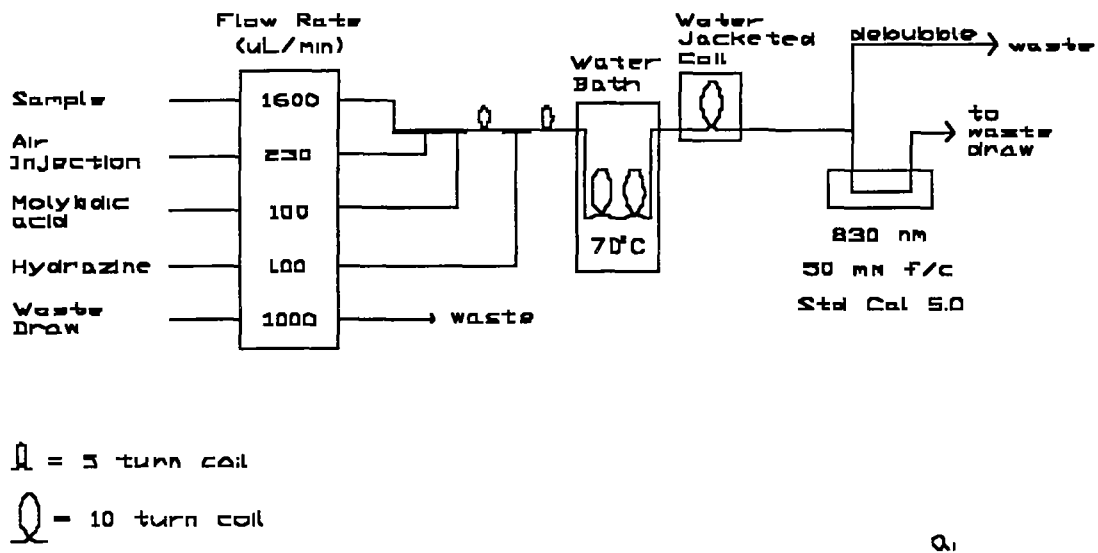

Figure 8.2.a Flow diagrams for the phosphate method. a. OSU AA-II method. See text for wavelength considerations. BPM signifies bubbles per minute.

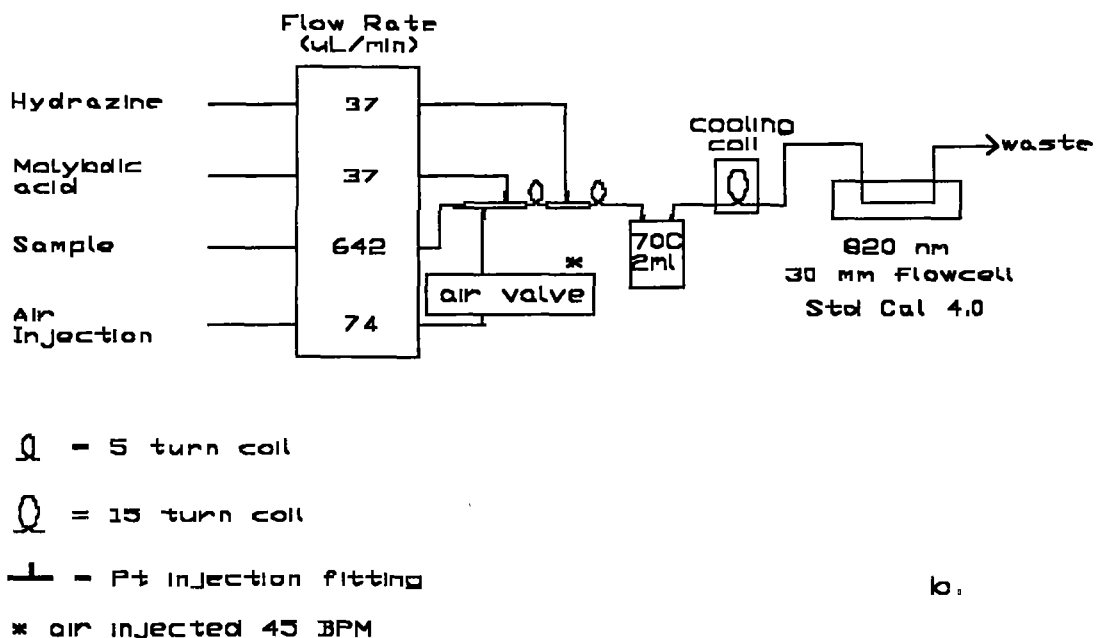

Figure 8.2.b Flow diagrams for the phosphate method. b. OSU RFA method. See text for wavelength considerations. BPM signifies bubbles per minute.

Note that the SIO-ODF analytical group uses an insulated air bath for the accelerated color development instead of a water bath. Also, in that modification, there is no water jacketed cooling coil between the heating bath and the colorimeter. Drafty conditions in some shorebased and shipboard labs might cause the sample stream entering the colorimeter to fluctuate in temperature and cause noisy colorimeter output. This needs to be checked for individual installations and conditions.

At this writing, the AA-II appears to give more dependable performance with the phosphate analysis. The RFA tends to be somewhat noisier and exhibits drift more frequently. When, as usual, it is functioning correctly it matches the AA-II in performance.

8.1.1 Reagent Preparation:

8.1.1.1 Molybdic acid reagent, 0.186 μM in 6.3 μM sulfuric acid.

8.1.1.1.1 Ammonium molybdate, 0.088 μM ; 109 g $(\text{NH}_4)_6\text{Mo}_7\text{O}_{24}\cdot 4\text{H}_2\text{O}$, diluted to 1000 ml with DIW. **NB.** Seven moles Mo/mole ammonium molybdate enters the calculation of the concentration of the final reagent.)

8.1.1.1.2 Sulfuric acid, 8.8 M; carefully add 1280 ml concentrated H_2SO_4 to 1620 ml DIW. Allow to cool between partial additions. Cool to room temperature.

8.1.1.1.3 Molybdic acid. Mix above and allow to cool. If the reagent has a bluish tinge or a precipitate develops, discard it and prepare a new solution. Store in a dark polyethylene bottle. This is usually stable for three to four months.

Requirement: AA-II, 150 ml/24 hours; RFA, 54 ml/24 hours.

Note: A molybdic acid reagent using 224 g ammonium molybdate instead of 109 g gave an increase in absorbance of approximately 15% at the level of 2.5 μM HPO_4^{2-} . However, this reagent caused very high reagent blanks and excessive baseline drift. All linearity and other tests were performed with the reagent concentration listed above.

8.1.1.2 Hydrazine sulfate, 0.062 μM (1% w/v).

2.5 g dihydrazine sulfate, $(\text{NH}_2)_2\text{SO}_4$, are dissolved and diluted to 250 ml with DIW. This reagent is usually consumed before any sign of instability is noticed; no particular storage requirements. Requirement: AA-II, 150 ml/24 hours; RFA 54 ml/24 hours. 0.5ml Aerosol-22 per 250ml may be added to this reagent.

8.1.1.3 *Wash Water:* Artificial seawater should be used to wash between samples. This will greatly reduce noise in the recorder trace caused by refractive effects of switching between seawater and distilled water. Natural seawater having a very low concentration of nutrients also can be used if a plentiful and cheap source is available.

8.1.1.4 *Wetting agents:* The methods presented here do not use wetting agents, relying instead upon keeping the flow system scrupulously clean. Some workers have reported problems with interferences and erratic baselines when using wetting agents with the phosphate analysis. Experience at OSU is consistent with these observations.

8.2 Nitrate:

The nitrate + nitrite analysis uses the basic method of Armstrong et al. (1967) with modifications to improve the precision and ease of operation. The original method is unacceptably non-linear at concentrations above ca. 15 μM . To achieve a more linear response in the AA-II system we dilute the sample. One scheme requires one sample

tube (0.23 ml/min) and a DIW dilution tube (1.20 ml/min), an arrangement which provides linearity up to 40.0 μM and adequate sensitivity for deep water nitrate samples. Alternatively the buffer solution may be diluted and its pump tube size increased to provide the necessary dilution while keeping the sample tube size constant. A similar procedure may be employed with the RFA. The methods shown here include the latter modification. Conversely, at low concentrations, higher sensitivity can be had by concentrating the buffer solutions and using higher sample to buffer flow rate ratios.

The manifolds for the analysis are shown in Figure 8.3. For the AA-II a 15 mm flow-cell, selenium photocells and 520 nm interference filters are used in the colorimeter. For the RFA the standard Alpkem phototubes and 540 nm filters are used. At the wavelengths shown the analytical sensitivity is ca. 0.0048 AU/ μM nitrate (and/or nitrite) in the sample stream. Maximum absorbance for the highest open ocean concentrations is ca. 0.25 AU.

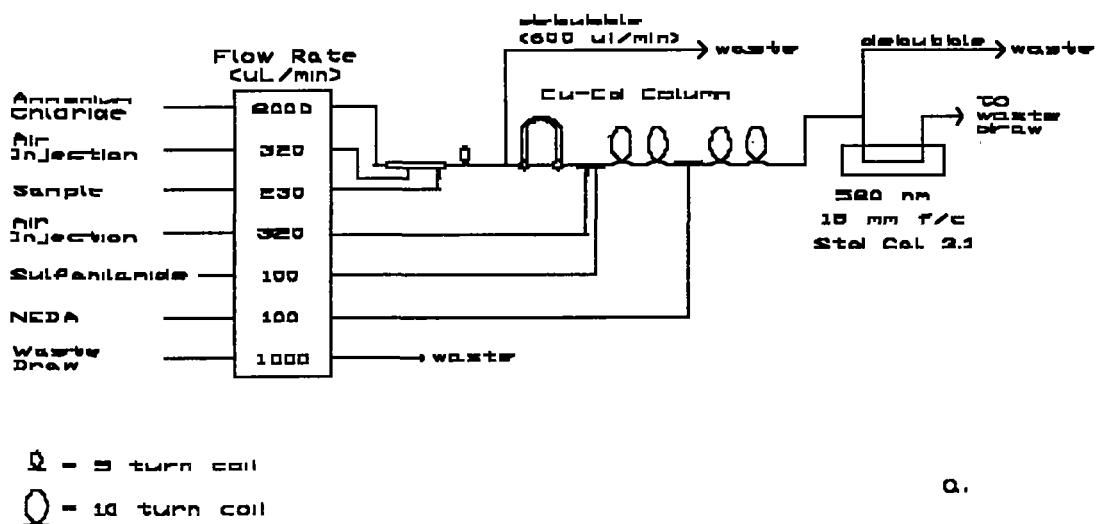

Note that the two small circles at the ends of the “U”-shaped cadmium column in the AA-II diagram denote two, three-way valves used to switch the column in and out of the flow system without having to shut off the pump. One four-way valve can also be used: Care must be used in selecting and using a suitable valve to minimize bubble breakup or introduction of unwanted dead volume into the sample stream. Care must be exercised in turning an otherwise satisfactory valve to the proper position to avoid bubble breakup. In some installations only one three-way valve is used, the downstream one being replaced by a tee. This diverts the flow around the column but does not completely isolate it from the sample stream. The end left open can allow slow diffusion of unbuffered rinse water into the column, as the pressure in the system oscillates during the channel shutdown and start-up periods. With attention paid to this possibility, the system can be operated without undesirable column degradation.

“Copperized” cadmium reduces nitrate to nitrite in both the AA-II and RFA methods. (The methods actually measure this nitrite.) The AA-II uses a packed column, the RFA an open tube cadmium reductor (OTCR). The latter has the advantage of being more convenient to use, lower toxicity hazard in handling and no requirement for debubbling the flow stream prior to its entry into the reductor. It is purchased completely fabricated for conditioning and insertion into the system. Its main disadvantage is its high cost. From time to time vendors have supplied defective columns which required (no-cost)

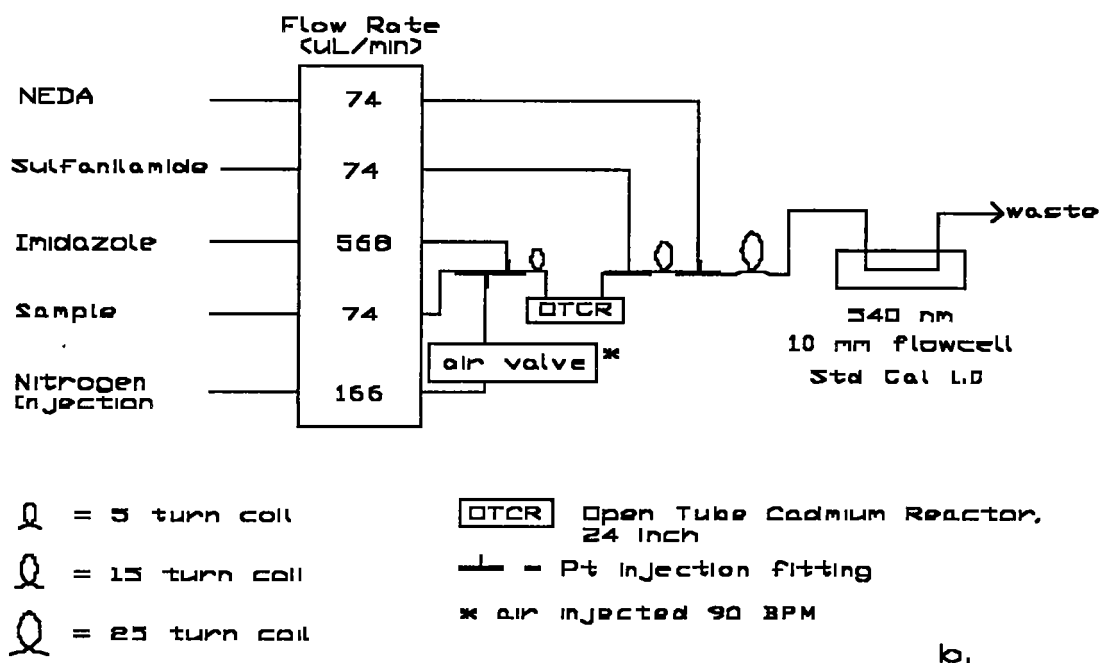

Figure 8.3. Flow diagrams for the nitrate method. a. AA-II. b. RFA See text for discussion of wavelengths. "ul/min" signifies µl/min.

replacement at some inconvenience to the user. Directions for preparing packed columns are given in section 8.2.2. For instructions on activating and maintaining the OTCR, see the Alpkem manual for the RFA-300 or RFA-II. We find their instructions complete and reliable. Although the OSU RFA method employs the OTCR, either reductor type can be used with good results. **N.B.** Take very seriously the Alpkem instructions for storage of the OTCR between measurement sessions. OTCR's can be irreparably destroyed by improper storage.

If, for analytical efficiency, as is recommended in this Protocol, the nitrate and nitrite channels are calibrated using mixed nitrate and nitrite working standards, reductor efficiency must be carefully monitored. This is done by comparing the response of the nitrate channel alternately to nitrate and nitrite standards at nearly full-scale nitrate concentrations. As an example one may place ten each, alternate 30 µM standard nitrate and nitrite solutions in the sampler. Note that nitrite salts are commonly less than 100% pure while nitrate reagent grade salts are typically 99.9% pure or better. This means that if the reductor were 100% efficient in reducing nitrate and also did not further reduce any nitrite it would be possible to observe 100% or greater efficiencies, that is, higher response to nitrate than to nitrite solutions of the same concentration. This rarely happens. Reductors usually gradually degrade yielding reduction efficiencies that can drop below 90%, 80% or less. Although the final degradation of the column can be rapid, the early stages of gradual degradation can be insidious. Garside (1993) has shown that for low column efficiencies (85%) and some combinations of nitrate and nitrite standard and sample concentration ranges serious systematic errors in observed nitrate concentration of more than 1 µM (up to 3% of deep water values) can occur.

To prevent this from happening, the analyst must regularly measure the reductor efficiency and monitor the magnitude of the nitrate sensitivity factor. The reductor effi-

ciency should be checked at least once a week and the sensitivity factor should be checked as quickly as possible at or even before the end of every set of analyses. For the WOCE program the reductor should be reactivated if the efficiency drops below 95% and replaced if reactivation cannot bring the efficiency above 95%. To minimize the adverse impact of low reductor efficiency, the nitrite calibration standard concentration should be kept as low as possible for the oceanic region of study. For open ocean studies, away from intense upwelling systems (e.g. northern Indian Ocean bays, Peruvian upwelling system) or open ocean locations like the Costa Rica Dome where high nitrite concentrations can be expected, nitrite calibration standards should be limited to at most ca. 1.0 μM .

8.2.1 Nitrate Reagents:

- 8.2.1.1 Ammonium Chloride buffer/complexing agent, NH_4Cl , 0.71 M (3.8% w/v) for the AA-II method. Dissolve 38 g NH_4Cl and 1 ml BRIJ-35 per liter in DIW. It's convenient to make this in 4 L batches because of the high consumption rates. Requirement: AA-II, 1400 ml/24 hours. This is the historical Technicon buffer but the RFA imidazole buffer which follows may also be used, with excellent results.
- 8.2.1.2 Imidazole buffer/complexing agent, 0.05 M , containing copper (3 μM), for the RFA method. Dissolve 6.8 g imidazole, $\text{C}_3\text{H}_4\text{N}_2$, in ca. 1500 ml DIW; add 30 ml ammonium chloride-copper sulfate stock solution (described below) and 2ml BRIJ-35; make up to 2000 ml with DIW. Adjust the pH to 7.8-7.85 with concentrated HCl (ca. 2 ml). This reagent is usually consumed before showing any signs of instability; no particular storage requirement.
Requirement: RFA, 820 ml/24 hours.
- 8.2.1.3 Sulfanilamide, 0.06 M (1% w/v) in 1.2 M HCl. Dissolve 10g sulfanilamide, 4- $\text{NH}_2\text{C}_6\text{H}_4\text{SO}_3\text{H}$, in 1 L of 1.2 M (10%) HCl. Stable at room temperature. Requirement: AA-II, 150 ml/24 hours; RFA, 106 ml/24 hours.
- 8.2.1.4 N-1-Naphthylethylene-diamine dihydrochloride, NEDA, 0.004 M . Dissolve 1 g NEDA, $\text{C}_{10}\text{H}_7\text{NHCH}_2\text{CH}_2\text{NH}_2 \cdot 2\text{HCl}$, in 1 L of DIW. Refrigerate in an airtight, dark bottle; discard if colored. Requirement: AA-II, 150 ml/24 hours; RFA, 106 ml/24 hours.
- 8.2.1.5 Ammonium chloride-copper sulfate stock solution, 4.7 M NH_4Cl - 0.2 mM CuSO_4 . Dissolve 250 g ammonium chloride, NH_4Cl , in 1 L DIW, add 2.5 ml copper sulfate stock solution. Requirement: One liter lasts for more than one month-long cruise.
- 8.2.1.6 Copper sulfate stock solution, 0.08 M . Dissolve 20 g cupric sulfate pentahydrate, $\text{CuSO}_4 \cdot 5\text{H}_2\text{O}$, in 1 L DIW. Stable at room temperature. Requirement: One liter lasts for much more than a month-long cruise.

8.2.2 Cadmium Column Preparation and Maintenance:

For the AA-II. Figure 8.4 shows a Cd-Cu packed column. (Packed columns are used in all AA-II work and may also be used for the RFA. More on this later.) Note that SIO-ODF uses unwaxed dental floss rather than glass wool for item 5.

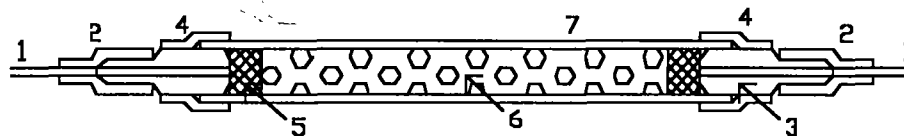

Figure 8.4. Packed Cd-Cu reduction column for use in AA-II nitrate analysis: 1. Teflon tubing (1 mm I.D.); 2. Tygon sleeving; 3. Technicon N-6 nipple; 4. Tygon tubing (1/4"); 5. Glass wool plug; 6. Copperized cadmium granules; 7. Glass tubing (~1/4" O.D., 3" long) or vinyl tubing of similar dimensions formed into a "U".

8.2.3 Prepare the column as follows:

- 8.2.3.1 Sieve 250 g of E. Merck¹ granulated cadmium (Product No. 2001) keeping the 20-50 mesh size fraction.
- 8.2.3.2 Wash sieved granules several times with isopropyl alcohol, DIW and 1.2 M HCl; rinse well with DIW.
- 8.2.3.3 Wash granules with 75-100 ml of 2% w/v copper sulfate stock solution. Repeat, allowing the blue color of the solution to disappear before decanting and adding fresh solution. After treating the granules with about 500 ml of 2% copper sulfate solution they should appear bright again. Wash the "copperized" granules with DIW several times to remove all colloidal Cu. **From this point on, it is very important to avoid any further exposure of the cadmium granules to the air. They must be kept covered with DIW or buffer/complexing agent at all times.** For this reason, some workers prefer to pack the column before copperizing and to then copperize the packed column either using syringes for the copperizing, washing and conditioning solutions or doing it online using the system pump (e.g. Mostert, 1988). However, great care must be taken to prevent passing fine copper particles into the flowcell! Therefore one must disconnect the outlet of the column from the rest of the system and pass its effluent to waste during online copperizing and washing steps. Failure to observe this precaution may cause noisy traces during analysis because of copper particles trapped in the flowcell.
- 8.2.3.4 Transfer the granules in suspension to the column (see Wood et al., 1967). To prevent trapping of air bubbles, the column should be filled with water and the lower connecting tubing sealed off. The full column should be tightly packed with the granules, tapping while filling to assure this. Carefully add the other end fitting without adding air bubbles. In this form, the column can be stored air free for several weeks. The column body may be either glass or PVC tubing. PVC is less fragile. Segmenting the flow stream with nitrogen instead of air in the AA-II method, as is done with the RFA, will give longer column life.

1. Can be purchased through E. M. Laboratories, 500 Exec. Blvd., Elmsford, N. Y. 10523.

- 8.2.3.5 The column is conditioned on stream. Before introducing the column to the sample stream, start the buffer through and allow sufficient time for it to flush the system beyond the column inlet. Momentarily stop the pump. Add the column to the sample stream keeping it free of air bubbles. Restart the pump. Stopping the pump is not necessary if a single three-way or a four-way valve is used to isolate the column. The column is then conditioned by running 30 ml of 2.5% w/v Na₂EDTA and 10 ml of 60-100 μM nitrate standard through it. (SIO-ODF finds the EDTA conditioning step unnecessary.) **Be sure to remove and flush any sulfanilamide reagent from the system before this conditioning. The acidic sulfanilamide reagent can precipitate the EDTA and clog the flowcell or a transmission line.** Columns prepared and conditioned in this way remain effective for hundreds to thousands of samples.

For the RFA. Either a packed column or an open column tubular reductor (OCTR) may be used. The OCTR has the advantage that the flow stream does not require debubbling before passage through the reductor. The presence of a debubbler in the system increases carryover as noted earlier in this Protocol. The useful lifetime of an OCTR seems to be comparable to that of a packed column reductor. Reduction efficiency is also comparable. However, some workers have chosen to use packed columns with the RFA and have accepted the need for debubbling, claiming better performance or column life. If a packed column reductor is used for the RFA its inside diameter should be reduced by a factor of ca. 2 from the AA-II, and debubbling will be necessary. It may also be necessary to use a finer size fraction for the cadmium granules. The OSU group has no experience using packed column reductors with the RFA systems.

Preparation of the OCTR is similar to the preparation of the packed column reductor with obvious differences such as not having to transfer cadmium granules to the reductor. The OCTR is particularly convenient and easy to clean, copperize and condition. Most operations are easily performed using 5 or 10 ml plastic syringes to hold the successive reagents. The detailed instructions for preparing and maintaining the OCTR that come with the RFA systems are clearly written and should be followed carefully to assure proper operation and long life of the OCTR. Imidazole is the usual buffer/Cd complexing agent for the OCTR and may be used quite successfully with packed columns as well.

8.2.4 Factors Affecting the Success of the Methods:

- 8.2.4.1 The sample/dilution mixture must be thoroughly mixed prior to entering the debubbler in the AA-II method.
- 8.2.4.2 Bubbles must be rigorously excluded from the reducing column in the AA-II method.
- 8.2.4.3 The column should be well packed but not so densely that flow is impeded. Good packing minimizes dead space and greatly improves resolution.

- 8.2.4.4 Colloidal copper formed during the “copperizing” step causes serious problems and must be removed from the cadmium by thorough washing.
- 8.2.4.5 Whenever transmitting an unsegmented stream (e.g. the output tubes from packed Cd-Cu columns and debubblers) use small bore (1 mm I.D.) tubing. This decreases transmission time and minimizes carry-over of samples.
- 8.2.4.6 Both packed columns and OTCR's should be kept filled with buffered sample or buffered DIW stream at all times; **never with unbuffered DIW or sample**. Before introducing the column into the flow stream, make certain that buffer has reached the reductor inlet point. When shutting down the system be sure to isolate the reductor before moving the buffer tube from the buffer reservoir to DIW. A microbore, four-way valve at this point in the system works very well for this as does a three-way valve (cf. section 8.2).
- 8.2.4.7 Linearity checks are important in the nitrate method.

8.3 Nitrite:

Nitrite analysis is performed on a separate channel, omitting the cadmium reductor and the buffer. The volume flow of the buffer is compensated by using a correspondingly larger sample pump tube; this also increases sensitivity. Nitrate concentrations never become high enough in the open oceans for the system response to become unacceptably nonlinear. The colorimeter sensitivity may also be increased by resetting the “Standard Cal” potentiometer and or using a longer flow cell. The resultant flow system is shown in Figure 8.5. All reagents required are described in Section 8.2.1. At the wavelengths indicated the analytical sensitivity is 0.056AU/ μM nitrite in the sample stream. Maximum absorbance for the highest open ocean concentrations is 0.25 AU.

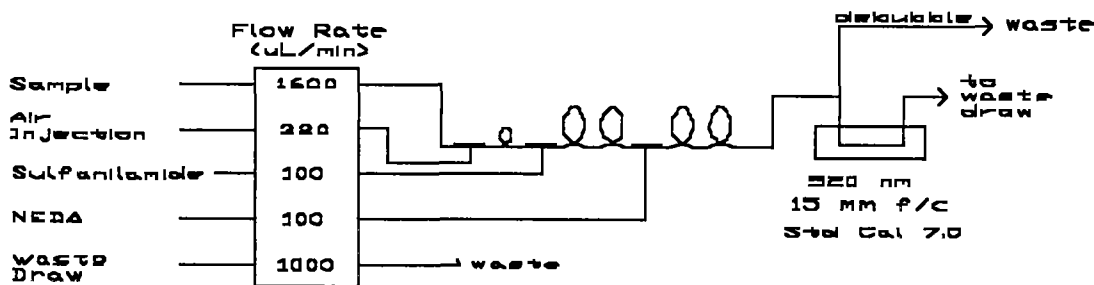

R = 5 turn coil
 Q = 10 turn coil

a.

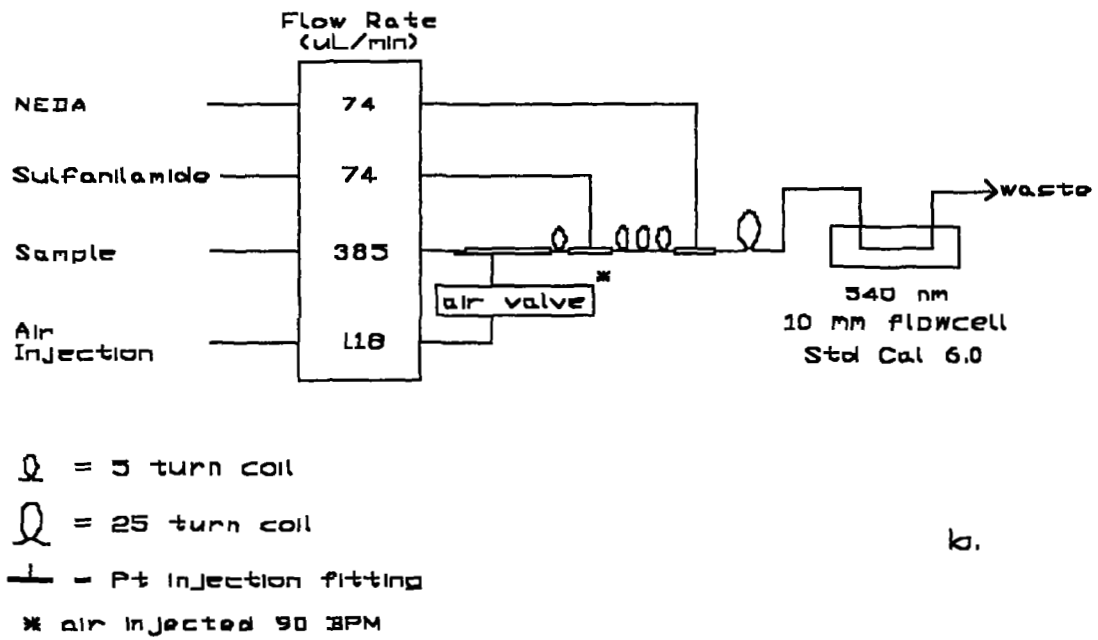

Figure 8.5. Flow diagrams for the nitrite method. a. AA-II. b. RFA. See text for discussion of wavelength. "µl/min" signifies µl/min.

8.4 *Silicic Acid:*

The method is based on that of Armstrong et al. (1967) as adapted by Atlas et al. (1971). The modifications presented here reduce its sensitivity to laboratory temperature (Gordon et al., in preparation). The rationale is explained in a later paragraph.

The Armstrong et al. silicic acid method is excessively nonlinear at deep-water concentrations. The modified method shown also reduces the nonlinearity to an acceptable degree over the oceanic concentration range of 0-200 μM silicic acid. However, considerable nonlinearity can also be corrected in the data processing stage as is done by the SIO-ODF. At the wavelengths indicated the sensitivity is ca. 0.006 AU/ μM silicic acid in the sample stream. Maximum absorbance for the highest, open ocean concentrations is ca. 1.0 AU.

Figure 8.6 shows our flow diagrams and operational parameters for the silicic acid analysis. The colorimeter for the AA-II uses a 15 mm flowcell pathlength, 660 or 820 nm interference filters and Technicon S-10 phototubes. The interference filters for the RFA are either 815, 820 or 660 nm and the flowcell pathlength is 10 mm. The 660 nm choice for the AA-II reduces the degree of nonlinearity. Although sensitivity is less at this wavelength, the method is sufficiently sensitive for deep, "blue-water" work. The absorbance maximum lies at ca. 813 nm and at that wavelength somewhat better sensitivity and, to some extent, linearity result. Unfortunately filters close to this wavelength have not been available until recently. They are now available at 815 nm for the RFA but not for the AA-II. Results at this wavelength have been favorable so far. Some methods call for work at 880 nm. Spectra for blanks taken at OSU have shown considerable blank absorbance and this wavelength also lies well down the side of the absorbance maximum, not an ideal analytical condition.

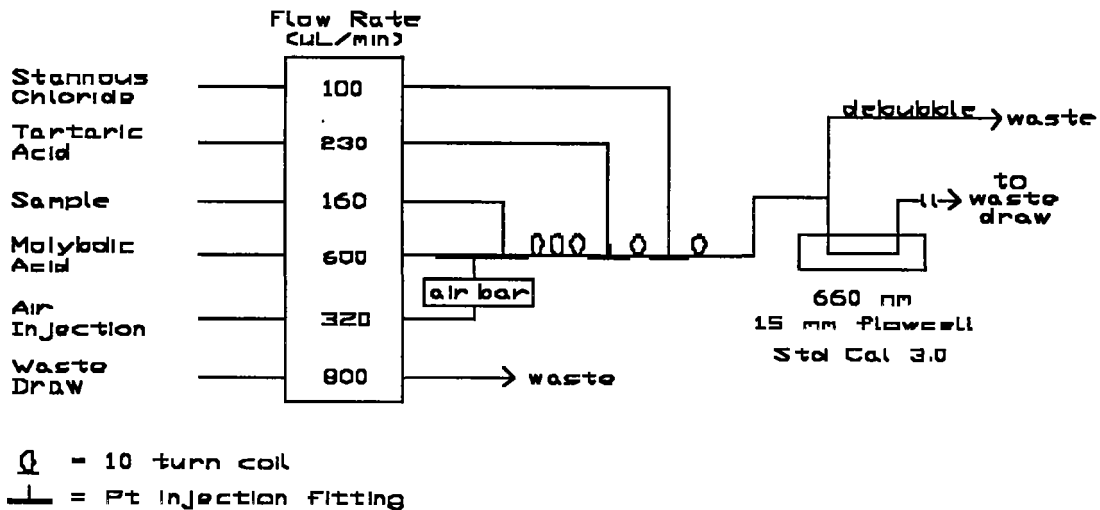

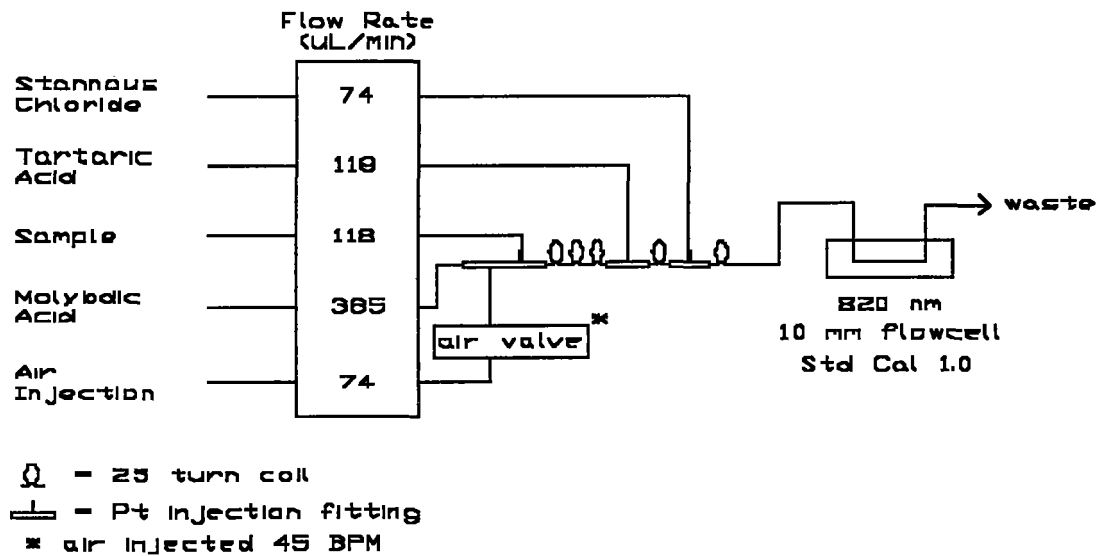

b.

Figure 8.6.b. Flow diagrams for the silicic acid method. (b) RFA. See text for wavelength considerations, also for differing parameters at OSU and SIO-ODF.

The marked temperature sensitivity of the Armstrong *et al.* method is caused by the very short time allowed for production of silicomolybdic acid by reaction of the molybdic acid and the silicic acid in the sample. The kinetics of this reaction are, of course, temperature dependent. The initial rate of increase in silicomolybdic acid, and hence the ultimate absorbance, is quite fast. By allowing the reaction to go closer to completion the temperature-dependent kinetics become less important. The laboratory temperature effect is ca. 20 times less than the Armstrong *et al.* method formerly used at OSU. A reviewer of an earlier draft of this manual stated that methods using ascorbic acid or metol as the reductant to silicomolybdic acid are not dependent upon laboratory temperature. Because the effect appears to be caused by the formation of silicomolybdic acid prior to reduction, it would be difficult to understand how this could be. This has not been checked at OSU. Some workers choose to heat the sample stream after addition of molybdic acid. This should also solve the temperature dependence problem but at the cost of more added complexity to the system.

The SIO-ODF method for the AA-II uses somewhat different analytical parameters from OSU's. Typical SIO-ODF flow rates are, in µl/min: sample, 420; stannous chloride, 100; tartaric acid, 320; DIW, 1200; molybdic acid, 160; air injection, 320; and waste draw, 1400. Also the molybdic acid reagents differ. Because the sample stream is diluted less, the SIO-ODF method is more nonlinear.

Figure 8.6.a. Flow diagrams for the silicic acid method. (a) AA-II. See text for wavelength considerations, also for differing parameters at OSU and SIO-ODF.

8.4.1 Reagent Preparation:

Molybdic acid reagent for AA-II, SIO-ODF, 0.113 μ M in 0.74 μ M HCl.

8.4.1.1 Ammonium molybdate stock solution, 0.0405 μ M (5% w/v). Dissolve 50 g $(\text{NH}_4)_6\text{Mo}_7\text{O}_{24}\cdot 4\text{H}_2\text{O}$ in 1000 ml DIW. This 5% molybdate stock solution is stable for several months if stored in a dark, air-tight bottle. If a white precipitate forms, the solution should be discarded and a fresh batch prepared.

8.4.1.2 Hydrochloric acid, 1.24 μ M (10% v/v). Add 100 ml concentrated HCl to 800 ml DIW, mix, bring to 1000 ml, mix.

8.4.1.3 Molybdic acid reagent Mix 200 ml 5% ammonium molybdate stock solution with 300 ml 1.24 μ M HCl. Requirement: For AA-II, 230ml/24 hours.

8.4.1.4 Molybdic acid reagent for RFA and OSU AA-II, 0.061 μ M in 0.03 μ M sulfuric acid.

Dissolve 10.8g ammonium molybdate, $(\text{NH}_4)_6\text{Mo}_7\text{O}_{24}\cdot 4\text{H}_2\text{O}$, in 1000 ml DIW containing 2.8ml concentrated H_2SO_4 and 2.0ml 15% SLS per liter. Requirement: For AA-II, 900 ml; RFA, 555 ml/24 hours.

8.4.1.5 Tartaric Acid, 1.25 μ M (20% w/v) in DIW for both AA-II and RFA. Dissolve 200 g tartaric acid, $\text{HOOC}(\text{CHOH})_2\text{COOH}$, in 950 ml DIW. Filter every ten days. Add one ml of reagent grade chloroform per 4 liters for preservation, refrigerate. Do not add too much chloroform; its solubility limit is ca. 0.6% in DIW; droplets of undissolved chloroform can cause noisy traces if they find their way to the flowcell. Requirement: AA-II, 470 ml/24 hours; RFA, 170 ml/24 hours.

8.4.1.6 Stannous Chloride

8.4.1.6.1 Hydrochloric acid, 6 μ M (50% v/v). Dilute 50 ml concentrated HCl to 100 ml with DIW, mix. The resulting concentration is only approximately 6 μ M but need not be more exact than this.

8.4.1.6.2 Stannous chloride stock solution, ca. 4.4 μ M (50% w/v) in ca. 6 μ M HCl. Dissolve 50g $\text{SnCl}_2\cdot 2\text{H}_2\text{O}$ in 6 μ M HCl and make up to 100 ml with 6 μ M HCl. **Store in a plastic bottle in a freezer at -10 C or below. If no freezer is available, store under mineral oil with a piece of mossy tin added.** At freezer temperatures the solution is stable for one to two months.

8.4.1.6.3 Stannous chloride working solution, ca. 0.11 μ M (ca. 1.1%) in 1.3 μ M HCl. Dilute 5 ml of stannous chloride stock solution to 200 ml with 1.2 μ M HCl. Make up fresh daily. Refrigerate whenever possible. A piece of mossy tin may be added. Requirement: AA-II, 150 ml/24 hours; RFA, 107 ml/24 hours.

8.4.1.6.4 SLS, 0.5 μ M (15% w/v). Dissolve 15g sodium lauryl sulfate ($\text{C}_{12}\text{H}_{25}\text{NaO}_4\text{S}$) in 87ml DIW.

8.4.2 *Reagent Notes.*

- 8.4.2.1 The stannous chloride reagent deterioration can be very rapid and may cause an unstable baseline, poor peak shapes and, in case of total deterioration, no response at all. When experiencing these problems with the silicate analysis, this is the first place to look for the remedy.
- 8.4.2.2 Stannous chloride as purchased, or sometimes after prolonged storage, does not always dissolve completely. An insoluble white residue remains and the reagent is unfit for use. Therefore, all new batches or batches that have been stored for some time since last being used should be tested! SIO-ODF recommends use of anhydrous stannous chloride finding that it stores better than the dihydrate. This hasn't been checked at OSU.
- 8.4.2.3 Tin is not an environmentally friendly pollutant. Some in the nutrient analyzing community use more benign reagents. Ascorbic acid is used by some groups, metol by others; work at OSU indicates there are some disadvantages to using ascorbic acid and further work continues.
- 8.4.2.4 Again, care must be taken to monitor the silicic acid concentration of the DIW used for measuring the reagent blank for several days after leaving port (see Section 5.1).

9.0 Calculations.

The data processing described in this section consists of converting a set of voltage readings to concentrations of nutrients in the samples analyzed. The voltages read are analogs of optical absorbance of the sample streams flowing through the colorimeters.

The two main steps are to correct the absorbance (voltage) data for a number of zero-offset errors, and to multiply the corrected absorbances by appropriate response factors, or “sensitivities,” for the various analyzer channels. The zero-offset corrections include:

- (a) correction for nutrient impurities in the reagents and impurities in the reagents that behave like the nutrients in generating measurable color in the flow stream. This correction is termed the “reagent blank,”
- (b) errors in the optics arising from the difference in refractive index between deionized water and seawater. This correction is the “refraction correction,” (Atlas et al., 1971), and
- (c) the electronic and/or optical zero offset of the colorimeter/recorder system. This correction is made manually when adjusting the CFA colorimeters at the start of analysis and does not appear explicitly in the computations.
- (d) An error having a similar behavior arises from the contamination of a sample in the flow stream by a residuum of the previous sample. This is commonly called the “wash-out” or “carryover” error. This affects all sample, standard and blank measurements, to a greater or lesser degree depending upon the differences in concentrations of successive samples entering the flow stream. It is highly dependent upon the presence of poorly flushed “dead volumes” in the flow stream and upon the sheer length and complexity of the flow stream. Unfortunately this error is time dependent, often having

characteristic times on the order of the residence time of one or a few samples in the flow colorimeter.

9.1 *Reagent Blank Estimation.*

Correction for the reagent blank depends upon a reliable source of a nutrient-free solution. Ideally, this would be nutrient-free natural seawater. However it is extremely difficult in practice to obtain or prepare nutrient-free seawater. Deionized water (DIW) is used instead. Sufficiently nutrient-free DIW is quite easy to prepare routinely and reliably at sea (see Section 4.2). **NB.** DIW prepared by ion exchange techniques can become contaminated by high levels of silicic acid in the fresh water supply. This can happen, and has too often happened, when ships take on fresh water in ports of call.

One measures the reagent blank by introducing two or more samples of DIW at the beginning and at the end of each batch of samples analyzed. In principle, the absorbance developed by these samples will result only from:

- a) the presence of nutrient impurities in the reagents.
- b) from the colorimeter's optics and electronics (instrumental zero) and.
- c) nutrients present in the wash water introduced between samples.

Thus, one can subtract the reagent blank absorbance from all the remaining samples and standards and arrive at the absorbance arising just from the nutrients contained in those standards and samples. But note that the instrument zero can drift measurably; experience shows that this drift is generally monotonic and linear with time. Therefore the combined instrument zero and reagent blank absorbances (readings for DIW) are regressed upon position number in the batch being analyzed and interpolated values subtracted from all sample absorbances. They may also be subtracted from standard and standard matrix absorbances; in that case they cancel out upon taking differences to calculate response (or “sensitivity”) factors as will be explained later. Note that it is not necessary to bring the output signals down to the reagent blank level between each pair of samples by prolonged “wash times!” When operating properly a CFA should not drift enough to make this necessary for the nutrient methods described here. Operation in this mode approximately doubles the analysis time; the result is more or less degeneration of the samples by bacterial activity and loss of operational efficiency. The only purpose of the intersample wash is to provide an easily detected mark between the output signals of adjacent samples!

9.2 *Refraction Error Estimation.*

The use of DIW to measure the reagent blank corrections introduces a new source of error, the refraction error (Atlas et al., 1971). It derives from the difference in refractive indices of pure water and seawater and the imperfect optics of the AutoAnalyzer or RFA flow cell. (Were the end windows of the flow cell planar and parallel to each other, the light beam perfectly collimated and the flow cell's inside diameter sufficiently larger than the diameter of the light beam there would be no error from this cause.) The measured “reagent blank” therefore includes both the true reagent blank and this refractive error.

To measure the refractive error itself one first removes a critical reagent from each analyzer flow stream, replacing the reagent with DIW. The critical reagent selected is the one contributing least to the total ionic strength of the stream and its total flow rate and whose absence assures complete elimination of color development at the wavelength of absorbance measurement. Then, one passes a series of alternating DIW and natural seawater samples through the system, records the absorbances and computes the refraction error, d , as the average difference with regard to sign. At least ten differences should be obtained.

$$d = \frac{\Sigma (A_{SW} - A_{DW})}{n}$$

where:

d = refraction error

A = absorbance

n = number of differences between seawater and DIW peaks

DW = DIW

SW = seawater

This procedure is followed for all analytical channels and the resulting average refractive corrections are subtracted from the signals of all samples, working calibration standards (including standard matrices). The refractive correction is sensitive to reagent and sea salt concentrations in the flow cell, colorimeter "Standard Cal." or range settings, and recorder gain settings. Therefore it must be remeasured after any change in pump tubes, even if no pump tube sizes have been changed, and any change in any of these colorimeter or recorder settings! Note that the sign of the refraction may be negative. Given CFA system optics, this is a possible and acceptable case and attention must be paid to the sign of the correction.

Typical refraction errors range from zero for silicic acid to one or two percent of full scale concentration for phosphate. The error, with the AA-II optics, can be as much as three percent of deep-water phosphate concentrations. Fortunately these errors are quite constant and measurable with good precision. Thus, the variability is less than 0.1% for silicic acid, ranging to ca. 0.3% at most for phosphate, with respect to deep water concentrations.

9.3 *Computation of Carryover Correction.*

The carryover results from the finite and more or less incomplete flushing of the flow system between samples. Thus an error is present in any given absorbance reading. Angelova and Holy (1983) have shown that the carryover signal can be approximated

as linearly dependent upon the difference between the absorbance of a given sample and that of the preceding sample for a linear system:

$$o = k(A_i - A_{i-1})$$

where:

o = carryover correction

k = carryover coefficient

i = sample position number

A_i = absorbance of the first full-scale standard

A_{i-1} = absorbance of the near-zero standard preceding the first full-scale standard

To correct a given absorbance reading, A_i , one then adds the carryover correction:

$$A_{i,c} = A_i + o$$

where:

$A_{i,c}$ = corrected absorbance

The carryover coefficient, k , is obtained for each channel by measuring the difference between the absorbances of the second and first full-scale standards following a near-zero standard or sample, all having the same, natural seawater matrix composition. It can equally well be calculated from the difference between the first two near-zero standards following a full-scale standard or sample. Measurement of the carryover is done in triplicate at the beginning of a cruise in order to obtain a statistically significant number. It must be checked carefully every time any change in plumbing of a channel is done, including simple pump tube or coil replacement.

The formula for k is:

$$k = \frac{A_{i+1} - A_i}{A_i - A_{i-1}}$$

where:

A_i = Absorbance of the first full-scale standard

A_{i+1} = Absorbance of the second full-scale standard

A_{i-1} = Absorbance of the near-zero standard preceding the first full-scale standard

Note that k is also valuable for monitoring system performance. Its value depends strongly upon several operational conditions such as constant timing of the pump and minimal dead volume in the flow system. Mechanical wear in the pump or pump tubes or dead volume accidentally introduced when maintaining the flow system can often be detected very quickly by monitoring k . To monitor for these effects, one should carefully record values of k and, if possible, accumulate them in a data quality control file and frequently and regularly plot k against time.

Carryover corrections for well designed and maintained channels are usually less than 0.3%. The worst cases are for systems with large volumes such as those containing heating baths (phosphate) or debubblers (AA-II channels) or packed bed columns (the nitrate reduction column).

9.4 *Calibration of analyzer response*

The response of each analytical channel per unit nutrient concentration is obtained by addition of known nutrient concentrations to natural seawater and measuring the resultant increases in absorbances. Using natural seawater assures that systematic effects (possible, unknown interferences) derived from natural seawater constituents will be present in both the calibration standards and seawater samples. However the natural seawater used for this purpose will, in general, contain finite concentrations of nutrients. It is not necessary that these concentrations be zero, only low, thus, “low-nutrient seawater” (LNSW). If the concentration were high to begin with, adding sufficient additional nutrients to obtain a usefully large signal might increase the total nutrient concentration enough that the analyzer response becomes nonlinear. In particular, this must be avoided if linear formulae for data processing are used. Even when nonlinear responses are corrected using nonlinear data processing techniques application of the corrections can become complicated if the matrix seawater contains appreciable nutrient concentrations. (OSU protocols strive for a mid-range nonlinearity of no more than 0.4% in all analyses and use a linear algorithm for data processing. The SIO-ODF employs a nonlinear algorithm.) In general, LNSW is acceptable if it contains less than ca. five percent of full-scale concentrations of all the nutrients. Given this condition the calibration procedure then consists of measuring both the LNSW and the LNSW with known additions of nutrients. The system response to nutrient addition is computed from the slope of the “Beer's Law” plot of measured absorbance versus standard additions to the matrix LNSW. Again, a nonlinear fit to this plot may be used.

Other than to correct the responses to the working standards for the nutrient content of the matrix LNSW the signals from the LNSW alone are of no intrinsic value. In some situations they're of value to monitor the DIW used for reagent blank measurement, for example when contamination of shipboard DIW occurs.

Calibration standards (at least in duplicate, preferably triplicate) must be placed at the beginning and end of each and every set of samples analyzed. Insert standards more often if the time required for a set exceeds one and a half hours. This time was selected on the basis of observed instrument response drift rates. Drifts in CFA response are usually linear and monotonic with time, similar to the situation with the zero offsets. The OSU data processing protocol regresses the observed beginning and ending response or “sensitivity factors” on sample number (counting blanks and standards as samples in this instance) and applies linearly interpolated “response factors” when computing con-

centrations. (Strictly speaking, the response factor as defined in the following equation is the reciprocal of sensitivity, hence the quotation marks.)

The response factors are computed from:

$$f = \frac{C_a}{(A_s - A_m)}$$

where:

f = response factor (or “sensitivity”)

C_a = added concentration of nutrient in the calibration standard

A_s = absorbance of calibration standard

A_m = absorbance of standard matrix seawater (LNSW)

9.5 *Summary of Steps for Computing Concentration:* To summarize, the data processing involves both additive corrections to the absorbances and multiplication of the fully corrected absorbances by the response factor to obtain the sample concentrations. The additive corrections can be made in the following sequence:

9.5.1 Correct all absorbances for carryover.

9.5.2 Regress the reagent blank absorbances against position number in the sample set and subtract the interpolated reagent blank from all absorbances. Strictly speaking, there is no need to do this for the calibration standard absorbances and their associated LNSW absorbances but there is no harm in doing so. It is simply easier to do it this way in most computer programs.

9.5.3 Subtract the refraction correction from all seawater sample absorbances. Again, there is no need to do this for the calibration standard and LNSW absorbances but it does no harm if done. This step produces fully corrected absorbances for all seawater samples.

9.5.4 Calculate the beginning and ending response factors, regress them against position number in the set and multiply sample absorbances by the interpolated values, giving the desired seawater concentrations.

Some of these computations can be carried out in orders other than what is given here. Three important points to note here are, a) that this procedure gives correct results, b) that the analyst must thoroughly understand the concepts involved before making any changes in the procedure and c) that the analyst must compare the results obtained by the changed procedure with those resulting from this one and be certain they agree over a variety of conditions and concentration levels before accepting the new procedure.

- 9.6 *Units for Expression of the Final Results and Conversion Factors:* The concentrations resulting from the preceding calculations are micromolar, that is, micromoles per liter (μM or $\mu\text{mol}\cdot\text{dm}^{-3}$) of the nutrient ion. Expressing nutrient concentrations in these volumetric units makes them numerically dependent upon the ambient pressure experienced by the seawater sample. In order to be free of this pressure dependence many workers, chiefly those in geochemistry, choose the pressure independent units, $\mu\text{mol}\cdot\text{kg}^{-1}$. To accomplish the numerical conversion it is necessary to know the density of the seawater samples at the time they are volumetrically drawn into the CFA pump and compared with the working standards whose concentrations are known in volumetric units. To do this one requires knowledge of the salinity of the samples and their temperature at analysis time. The salinities are generally known from the concomitant hydrographic observations. The sample temperatures closely enough approximate the laboratory temperature at the time the samples are analyzed. Fofonoff and Millard (1983) give a convenient algorithm for computing the density. The volumetric units are simply divided by the density to convert to pressure-independent gravimetric units.
- 9.7 *Computer Software:* The OSU group has developed a series of programs for nutrient data acquisition and processing. "DATABEEP," the first of these is a QuickBASIC program for control of a Keithley Instruments System500 data acquisition system in an IBM-PC type environment. It controls acquisition and digitization of the analog data from the flow colorimeters. It does this in "background" allowing the analyst to interact with DATABEEP's operational parameters in "foreground" to accomplish tasks like adjusting peak window delays and widths. DATABEEP's output is a raw, absorbance data file that can be edited and processed by the second program "NUTCALC."

NUTCALC, is also a QuickBASIC program. It carries out the computations described in this section in a menu-driven environment, operating upon an array of blank, standard and sample absorbances or voltage analogs. These can have been constructed by any digital data acquisition system including DATABEEP or by manually digitizing the data. It takes the raw data file through editing and processing steps to a new data file in concentration units. NUTCALC applies baseline and sensitivity drift (assumed linear and monotonic), applies carryover corrections, computes sensitivities (or calibration factors) and computes concentrations in micromolar units. Hydrographic and other bottle data can be entered into the nutrient data file, replicate samples averaged, sample depths entered, etc. Output from the program is in ASCII format.

NUTCALC and its companion programs including a multivariable plotting program are available on request from the authors at no cost.

10.0 Quality Assurance:

Quality assurance in nutrient analyses as with any analytical procedure begins with well designed and meticulously executed sampling methods. These have already been described. The same must be said for the execution of the actual analyses themselves. The analyst must carefully monitor the performance of the CFA at all times, correcting and noting any deviations from normal and acceptable performance.

It is imperative that the analyst not continue operation of the CFA should its performance not guarantee acceptably high quality data. In such a case operation must be halted and the

problem corrected. It's obvious that a CFA can generate a distressingly large amount of bad data in a short time if not properly maintained and operated. A gap in a data set is far less objectionable than a spate of bad data!

We'll go through a plan of quality assurance steps that can facilitate producing a good data set. This will include a program of replicate sampling to provide a measure of short-term, within laboratory precision, both for sampling from the water column and for analysis of homogeneous water samples by the CFA. Somewhat longer term precision can be evaluated by examining consecutive station agreement of deep samples and more rigorously by examination of variance along isopycnal surfaces over not-too-long horizontal distances.

- 10.1 *Replicate sampling*: Draw duplicate samples from two water samplers at each station. One pair is to be drawn from one of the deepest depths, another pair from the nitrate/phosphate maximum. Alternate the first with a mixed layer duplicate so that there is a good mix between low nutrient and high nutrient duplicates. The duplicates should be well separated in the sample tray and not placed in consecutive positions. As the cruise proceeds, maintain a cumulative log file of these replicate measurements.
- 10.2 *Replicate analysis*: For each station's set of samples, analyze two pairs of samples, selected in a manner similar to that in Section 10.1. Put seawater from each of the two sample bottles in two positions in the sampler tray. Again, the duplicates should be well separated in the sample tray and not placed in consecutive positions.
- 10.3 *Quality checks during operation*: Peak checking, offset detection. There are two general areas where the analyst must be diligent in maintaining quality assurance while operating the CFA and in the first steps of processing the data. First, the analyst must be conscientious to almost an extreme in constantly watching the flow characteristics of all channels of the CFA and monitoring the quality of the strip chart recorder traces. Second, if the data logging software implements an on-line computation and printout or display of root-mean-square noise on the sample peaks, the analyst must pay particular attention to abnormal variance and to correction of the cause.
- 10.4 *Multivariate plotting of vertical profiles*: As soon as possible following analysis of each station the analyst should construct a composite vertical profile plot of the nutrient data. Abnormal performance of water samplers and/or the CFA often show up as "flyers" in one or more of the nutrients. The nutrient analyst can often be the first person to notice the effects of a particular water sampler that habitually or often leaks. Sudden jumps in deep water concentrations observed upon overlaying subsequent vertical profiles can alert the analyst to a problem with preparation of a working or earlier stage calibration standard or with an unstable standard.
- 10.5 *Use of the WHPEDIT program*: The WHPEDIT program developed by the WOCE Hydrographic Program (WHP) Office serves as a highly sensitive device for the detection of flyers and offsets in the nutrient and other data. We heartily endorse its use. Further, the data originators in the WHP program, including the nutrient data originators, are responsible for the first round of assigning data quality flags to the data. WHPEDIT

has been expressly designed to assist with this process and makes the process much easier for the analyst than entering data quality flags into the WHP data format by hand.

- 10.6 *Comparison with historical data*: If the analysts have time at sea and if adequate historical data are available overlaying plots of the current data with the historical data is an excellent quality assurance technique. Care must be taken that the historical data are, in fact, of quality adequate for the purpose!

11.0 References

- Angelova, S., and H.W. Holy. 1983. Optimal speed as a function of system performance for continuous flow analyzers. *Analytica Chimica Acta* **145**: 51-58.
- Armstrong, F. A. J., C. R. Stearns, and J. D. H. Strickland. 1967. The measurement of upwelling and subsequent biological processes by means of the Technicon AutoAnalyzer and associated equipment. *Deep-Sea Res.* **14**(3): 381-389.
- Atlas, E. L., S. W. Hager, L. I. Gordon and P. K. Park. 1971. A practical manual for use of the Technicon Autoanalyzer in seawater nutrient analyses; revised. Technical Report 215. Oregon State University, Dept. of Oceanography, Ref. No. 71-22. 48 pp.
- Bernhardt, H. and A. Wilhelms. 1967. The continuous determination of low level iron, soluble phosphate and total phosphate with the AutoAnalyzer. Technicon Symp., 1967, Vol. I, p. 386.
- Chapman, P. and S.A. Mostert. 1990. Does freezing of nutrient samples cause analytical errors? *S. Afr. J. Mar. Sci.* **9**:239-247.
- Fofonoff, N.P., and R.C. Millard, Jr. 1983. Algorithms for computation of fundamental properties of seawater. UNESCO technical papers in marine science 44, UNESCO. 53 pp.
- Gilmartin, M. 1967. Changes in inorganic phosphate concentration occurring during seawater sample storage. *Limnol. Oceanogr.* **12**: 325-328.
- Garside, C. 1993. Nitrate reductor efficiency as a source of analytical error. *Marine Chemistry*, submitted.
- Gordon, L.I., J.M. Krest and A.A. Ross. in preparation. Continuous Flow Analysis of silicic acid in seawater: Reducing sensitivity to laboratory temperature fluctuations.
- Grasshoff, K., M. Ehrhardt, K. Kremling. 1983. Methods of seawater analysis. 2nd. ref. ed. Verlag Chemie GmbH, Weinheim. 419 pp.
- Group of Technical Experts on Nutrient Analysis for the WOCE Hydrographic Program. 1989. Unpublished minutes.
- Hager, S. W., L. I. Gordon and P. K. Park. 1968. A practical manual for use of the Technicon AutoAnalyzer in seawater nutrient analyses. Final report to Bureau of Commercial Fisheries, Contract 14-17-0001-1759. Oregon State University, Dept. of Oceanography, Ref. No. 68-33. 31 pp.
- Joyce, T., C. Corry and M. Stalcup, eds. 1991. Requirements for WOCE Hydrographic Programme data reporting. WHPO Publication 90-1 Revision 1. Woods Hole Programme

- Office, Woods Hole Oceanographic Institution. WOCE Report 67/91. UNPUBLISHED MANUSCRIPT. 71 pp.
- Kolthoff, I.M., E.B. Sandell, E.J. Meehan and S. Bruckenstein. 1969. Quantitative Chemical Analysis, 4th ed., Macmillan, London. 1199 pp.
- Macdonald, R.W., F.A. McLaughlin and C.S. Wong. 1986. The storage of reactive silicate samples by freezing. *Limnol. Oceanogr.* **31**(5):1139-1142.
- Mostert, S.A. 1988. Notes on improvements and modifications to the automatic methods for determining dissolved micronutrients in seawater. *S. Afr. J. Mar. Sci.* **7**:295-298.
- U.S. WOCE Office. 1989. U.S. WOCE Implementation Plan. U.S. WOCE Implementation Report Number 1. College Station, TX. 176 pp.
- Weast, R.C., M.J. Astle and W.H. Beyer, eds. 1985. CRC Handbook of Chemistry and Physics. 66th. edition.
- Weiss, R.F., W.S. Broecker, H. Craig and D. Spencer. 1983. GEOSECS Indian Ocean Expedition, Vol. 5, Hydrographic Data, 1977-1978. 48 pp.
- Wood, E. D., F. A. J. Armstrong, and F. A. Richards. 1967. Determination of nitrate in seawater by cadmium-copper reduction to nitrite. *J. Mar. Biol. Assoc. U. K.* **47**(1): 23-31.

Chapter 9. The Determination of Nitrate in Sea Water

1.0 Scope and field of application

This procedure describes a method for the determination of reactive nitrate in seawater. This method is suitable for the assay of oceanic concentrations between $0.05 \mu\text{mol l}^{-1}$ to $45 \mu\text{mol l}^{-1}$. This method is a modification of Strickland and Parsons (1968).

2.0 Definition

The concentration of reactive nitrate is given in $\mu\text{mol kg}^{-1}$ in seawater.

3.0 Principle of Analysis

The determination of nitrate is based on the method of Morris and Riley (1963) and modified by Strickland and Parsons (1968). Nitrate is reduced to nitrite using a cadmium-copper column. The nitrite produced reacts with sulfanilamide in an acid solution. The resulting diazonium compound is coupled with N-(1-Naphthyl)-ethylenediamine dihydrochloride to form a colored azo dye, the extinction of which can be measured spectrophotometrically.

The following stoichiometric equations apply.

3.1 Nitrate is reduced using a copper-cadmium column:

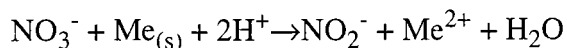

3.2 NO_3^- can easily be reduced further to NO due to the similar electromotive forces (E_0) of the reactions:

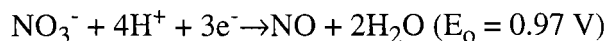

3.3 To ensure that this does not occur, the reaction takes place in a neutral or slightly alkaline solution.

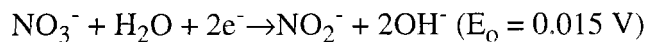

3.4 Ammonium chloride in the sample stream acts as both a complexant and as a buffer.

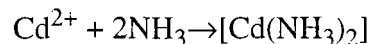
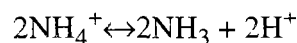

4.0 Apparatus

Spectrophotometer

5.0 Reagents

- 5.1 *Concentrated ammonium chloride solution:* Dissolve 125 g of reagent grade ammonium chloride (NH_4Cl) in 500 ml of de-ionized water. This solution may be stored in a glass or plastic bottle.
- 5.2 *Dilute ammonium chloride solution:* Dilute 50 ml of the concentrated ammonium chloride (NH_4Cl) solution to 2000 ml with de-ionized water. Store in a glass or plastic bottle.
- 5.3 *Sulfanilamide solution:* Dissolve 5 g of sulfanilamide in a mixture of 50 ml of concentrated hydrochloric acid and about 300 ml of de-ionized water. Dilute to 500 ml with de-ionized water. This solution is stable for many months.
- 5.4 *N-(1-Naphthyl) - ethylenediamine dihydrochloride solution:* Dissolve 0.50 g of the dihydrochloride in 500 ml of de-ionized water. Store in a dark bottle and renew monthly or if a brown coloration develops.
- 5.5 *Copper sulfate stock solution:* 2% w/v in de-ionized water. Dissolve 20 g cupric sulfate pentahydrate, $\text{CuSO}_4 \cdot 5\text{H}_2\text{O}$ in 1 liter de-ionized water. Stable at room temperature.

6.0 Sampling

- 6.1 Samples are collected on deeper casts after the oxygen, CO_2 and salinity samples have been drawn. Shallow samples (upper 250 m) are collected on the gases cast after oxygen, CO_2 , DOC and salinity samples are drawn. An in-line filter (0.8 μm Nuclepore filter) is connected to the Niskin bottle. The spigot is opened and three sets of samples are collected from the water that passes through the filter by gravity filtration. Each bottle is rinsed three times and then filled just below the shoulder. Care must be taken to avoid overfilling of samples to be frozen. These bottles are transferred to a freezer (- 20°C) and kept frozen until analysed.
- 6.2 Contamination is a major problem with nutrient samples, especially in the upper ocean where the ambient concentrations are low. All the nutrient bottles are rigorously cleaned before use. The cleaning begins by a wash with a detergent (Aquet) followed by a rinse with 10% HCl, three rinses with deionized water, and a final rinse with de-ionized water.
- 6.3 Prolonged storage of samples is not advisable, even if frozen.

7.0 Procedures

- 7.1 *Cadmium - copper column material:* Stir 100 g of acid-washed cadmium filings with 500 ml of a 2% (w/v) solution of copper sulphate pentahydrate, $\text{CuSO}_4 \cdot 5\text{H}_2\text{O}$, until all blue coloring has left the solution and copper particles enter the supernatant. This material is then used to pack the reduction columns, utilizing a small plug of copper “wool” as a plug at the bottom and top of the column. Columns are about 30 cm long and have a flow rate of about 10 ml/minute. The columns are washed with dilute ammonium chloride solution and the column material completely covered by dilute ammonium chloride solution when not in use. **Note:** About 50 g of cadmium filings are required for a column. In addition, cadmium that has become inefficient at reduction may be regenerated by washing with 5% (v/v) hydrochloric acid (300 ml for the cadmium from four columns) and rinsing with 300 ml portions of deionized water until the pH of the wash is greater than 5. The cadmium is then retreated with the copper sulphate solution before use.
- 7.2 *Sample analysis*
- 7.2.1 Samples should be at a temperature between 15° and 30°.
- 7.2.2 Add 1.0 ml of concentrated ammonium chloride solution to 100 ± 2 ml of sample in a 125 ml Erlenmeyer flask. Mix the solution.
- 7.2.3 Pour about 5 ml onto the top of the column and allow it to pass through.
- 7.2.4 Add the remainder of the sample to the column and collect the effluent back into the Erlenmeyer flask. Use the first 45–50 ml to wash the flask and a 50 ml graduated cylinder. Collect the next 50 ml in the graduated cylinder and pour this back into the flask. Allow the remaining sample to drain out through the column. Some dilute ammonium chloride may then be used to wash the column although this is not necessary unless the columns are not to be reused for periods exceeding one hour.
- 7.2.5 As soon as possible after reduction, add 1.0 ml of sulfanilamide solution to the sample in the flask and mix. Permit the reagent to react for between 2 and 8 minutes.
- 7.2.6 Add 1.0 ml of N-(1-Naphthyl)-ethylenediamine dihydrochloride solution and mix immediately.
- 7.2.7 Measure the extinction of the samples at 543 nm between 10 minutes and 2 hours after the addition of the naphthylethylenediamine reagent. Absorbances of less than 0.1 in a 1 cm cell should be re-read in a 10 cm cell.
- 7.3 *Reagent Blank Determination:* A reagent blank is barely significant when working with a 1cm cell but gains considerable importance when a 10cm cell is used. In either case it should be checked throughout each analysis. The reagent blank is determined using deionized water as sample and following the procedure outlined in section 7.2. Add the concentrated ammonium chloride solution to 100 ml of deionized water in a clean Erlenmeyer flask and use a column previously flushed with at least 50 ml dilute ammonium chloride solution just before. The absorbance of the blank should not exceed 0.1 using a 10 cm cell.

7.4 Standardization

7.4.1 Primary nitrate standard:

Dissolve 1.011 g of analytical reagent quality potassium nitrate in 1000 ml of deionized water. 1 ml=10 μ mol N

7.4.2 Working nitrate standard:

Dilute 4 ml of primary nitrate standard up to 2000 ml in low nutrient seawater. The solution should be stored in a dark bottle and prepared fresh immediately before each use (20 μ M).

7.4.3 Run approximately 100 ml of working standard solution as described in section 7.2. This should be performed in triplicate initially for each column. Thereafter, standards are to be run with each batch of samples to check the efficiency of the reduction columns.

8.0 Calculation and expression of results

8.1 A standardization factor F can be calculated as:

$$F = \frac{20 \mu\text{mol/kg}}{E_s - E_b}$$

where:

- 20 μ mol/kg = concentration of the standard
 E_s = mean absorbance of the standards
 E_b = mean absorbance of the blanks

8.2 The nitrate concentration is calculated by:

$$\mu\text{M NO}_3 = \text{corrected absorbance} \times F - 0.95C$$

where:

- F = standardization factor
 C = concentration of nitrite present in the sample
 corrected absorbance = sample absorbance - reagent blank

With good columns, 5% of the nitrite is reduced leading to a correction of 0.95 times the nitrite concentration of the sample is made.

9.0 Notes

9.1 *The cadmium-copper column:*

The column deactivates through continual use. The addition of the ammonium chloride should slow this process. A well-packed column should be capable of reducing at least 100 samples.

There is no need to wash the columns between the samples, but if the columns are not to be used for over an hour, 50 ml of dilute ammonium chloride should be run through the system. This aids in extending the life of the column.

The columns should be stored completely covered in liquid.

10.0 References

Morris and Riley. (1963). *Analytica Chimica Acta*, **29**, 272–279.

Strickland, J.D.H., and Parsons, T.R. (1968). Determination of reactive nitrate. In: *A Practical Handbook of Seawater Analysis*. Fisheries Research Board of Canada, Bulletin **167**, 71–75.

Grasshoff, K, M. Ehrhardt, M. and K. Kremling (1983). Determination of nutrients. In: *Methods of Seawater Analysis*. p. 143.

Chapter 10. The Determination of Nitrite in Sea Water

1.0 Scope and field of application

This procedure describes a method for the determination of reactive nitrite in seawater. This method is suitable for the assay of oceanic concentrations between $0.01 \mu\text{mol l}^{-1}$ to $2.5 \mu\text{mol l}^{-1}$. This method is a modification of Strickland and Parsons (1968).

2.0 Definition

The reactive nitrite concentration is given in units of $\mu\text{mol kg}^{-1}$ in seawater.

3.0 Principle of Analysis

The determination of nitrite is based on the method of Strickland and Parsons (1968). Nitrite reacts with sulfanilamide in an acid solution resulting in a diazonium compound. This is then coupled with N-(1-Naphthyl)-ethylenediamine dihydrochloride to form a colored azo dye, the extinction of which can be measured spectrophotometrically.

4.0 Apparatus

Spectrophotometer

5.0 Reagents

5.1 *Sulfanilamide solution:*

Dissolve 5 g of reagent grade sulfanilamide in a mixture of 50 ml concentrated hydrochloric acid and 300 ml of deionized water. This solution is diluted to 500 ml with deionized water, stored in a glass bottle, and is stable for many months.

5.2 *N-(1-Naphthyl) - ethylenediamine dihydrochloride solution:*

Dissolve 0.50 g of the dihydrochloride in 500 ml of deionized water. Store in a dark bottle and replace monthly or immediately if a brown coloration develops.

6.0 Sampling

6.1 Samples are collected on deeper casts after the oxygen, CO_2 and salinity samples have been drawn. Shallow samples (upper 250 m) are collected on the gases cast after oxygen, CO_2 , DOC and salinity samples are drawn. An in-line filter ($0.8 \mu\text{m}$ Nuclepore filter) is connected to the Niskin bottle. The spigot is opened and three sets of samples are collected from the water that passes through the filter by gravity filtration. Each bottle is rinsed three times and then filled just below the shoulder. Care must be taken to avoid overfilling of samples to be frozen. These bottles are transferred to a freezer (-20°C) and kept frozen until analysed.

- 6.2 Contamination is a major problem with nutrient samples, especially in the upper ocean where the ambient concentrations are low. All the nutrient bottles are rigorously cleaned before use. The cleaning begins by a wash with a detergent (Aquet) followed by a rinse with 10% HCl, three rinses with deionized water and a final rinse with de-ionized water.
- 6.3 Prolonged storage of samples is not advisable, even if frozen. Sufficient water should be sampled for washing purposes.

7.0 Procedures

7.1 *Sample analysis*

- 7.1.1 Samples should be at a temperature between 15° C and 30° C.
- 7.1.2 The 125 ml Erlenmeyer flasks and 50 ml measuring cylinder to be used in this analysis should be rinsed twice with the sample seawater and shaken dry.
- 7.1.3 Measure 50 ml of the sample into a 125 ml Erlenmeyer flask.
- 7.1.4 Add 1.0 ml of the sulfanilamide solution to each flask, mix, and permit the reagent to react for between 2 and 8 minutes.
- 7.1.5 Add 1.0 ml of the N-(1-Naphthyl) - ethylenediamine dihydrochloride solution and mix immediately.
- 7.1.6 Measure the extinction of the samples at 543 nm between 10 minutes and 2 hours after the addition of the naphthylethylenediamine reagent. Extinctions less than 0.1 in a 1 cm cell should be reread in a 10 cm cell.

7.2 *Reagent blank determination*

- 7.2.1 The reagent blank is determined using de-ionized water as sample instead of seawater, exactly following the procedure outline in section 7.1. This should be done in duplicate.
- 7.2.2 A reagent blank should not exceed 0.03 and should be determined for each batch of samples.

7.3 *Standardization*

- 7.3.1 *Primary nitrite standard:* Dissolve 0.345 g of dried anhydrous reagent grade sodium nitrite in 1000 ml of deionized water. 1 ml = 5 μ mol N. This solution is stored in a dark bottle with 1 ml of chloroform as a preservative and is stable for 1-2 months.
- 7.3.2 *Working nitrite standard:* Dilute 10.0 ml of the primary standard solution to 1000 ml with deionized water (1 ml = 0.05 μ mol).

- 7.3.3 Prepare four standard solutions by diluting 2.0 ml of working nitrite standard up to 50 ml in de-ionized water. Carry out the nitrite determination to each standard as described above in section 7.2.

8.0 Calculation and expression of results

- 8.1 A standardization factor F can be calculated as:

$$F = \frac{20 \mu\text{mol/kg}}{E_s - E_b}$$

where:

- 20 $\mu\text{mol/kg}$ = concentration of the standard
 E_s = mean absorbance of the standards
 E_b = mean absorbance of the blanks

- 8.2 The nitrite concentration is calculated by:

$$\mu\text{M NO}_2 = \text{corrected absorbance} \times F$$

where:

- F = standardization factor
 corrected absorbance = sample absorbance - reagent blank

9.0 References

Strickland, J.D.H., and Parsons, T.R. (1968). Determination of reactive nitrite. In: *A Practical Handbook of Seawater Analysis*, Fisheries Research Board of Canada, Bulletin **167**, 71–75.

Chapter 11. The Determination of Phosphorus in Sea Water

1.0 Scope and field of application

This procedure describes a method for the determination of reactive phosphorus in seawater, suitable for the assay of oceanic concentrations of 0.01- 2.5 $\mu\text{mol l}^{-1}$. This method is a modification of Strickland and Parsons (1968).

2.0 Definition

The reactive phosphate concentration is given in units of $\mu\text{mol kg}^{-1}$ in seawater.

3.0 Principle of Analysis

The determination of reactive phosphorus in seawater is based on the method proposed by Strickland and Parsons (1968). The seawater sample is allowed to react with a composite reagent containing ammonium molybdate, ascorbic acid and potassium antimonyl-tartrate. The resulting complex is reduced *in situ* to give a blue colored solution, the absorbance of which can be measured spectrophotometrically.

4.0 Apparatus

Spectrophotometer

5.0 Reagents

- 5.1 *Ammonium molybdate solution*: Dissolve 15 g of reagent grade ammonium paramolybdate, $(\text{NH}_4)_6\text{Mo}_7\text{O}_{24}\cdot 4\text{H}_2\text{O}$, in 500 ml of deionized water. The solution is stable indefinitely if stored out of direct sunlight in a plastic bottle. Discard if a precipitant forms.
- 5.2 *Sulfuric acid solution*: Add 140 ml of concentrated sulfuric acid to 900 ml of deionized water. Cool the solution and store it in a glass bottle.
- 5.3 *Ascorbic acid solution*: Dissolve 27 g of ascorbic acid in 500 ml of deionized water. This solution should be frozen in a plastic container. Thaw for use and refreeze at once.
- 5.4 *Potassium antimonyl-tartrate solution*: Dissolve 0.34 g of potassium antimonyl-tartrate in 250 ml of deionized water. This solution is stable for many months.
- 5.5 *Mixed reagent*: Mix together 100 ml ammonium molybdate solution, 250 ml sulfuric acid solution, 100 ml ascorbic acid solution and 50 ml potassium antimonyl-tartrate solution. Use at once and discard any excess. Do not store for more than 6 hours. Add molybdate last. Solution should have a yellow color.

6.0 Sampling

- 6.1 Samples are collected on deeper casts after the oxygen, CO_2 and salinity samples have been drawn. Shallow samples (upper 250 m) are collected on the gases cast after oxygen, CO_2 , DOC and salinity samples are drawn. An in-line filter (0.8 μm Nuclepore filter) is connected to the Niskin bottle. The spigot is opened and three sets of samples are collected from the water that passes through the filter by gravity filtration. Each bottle is rinsed three times and then filled just below the shoulder. Care must be taken to avoid overfilling of samples to be frozen. These bottles are transferred to a freezer (-20°C) and kept frozen until analysed.
- 6.2 Contamination is a major problem with nutrient samples, especially in the upper ocean where the ambient concentrations are low. All the nutrient bottles are rigorously cleaned before use. The cleaning begins by a wash with a phosphate-free detergent

(Aquet) followed by a rinse with 10% HCl, three rinses with deionized water and a final rinse with de-ionized water.

6.3 Prolonged storage of samples is not advisable, even if frozen.

7.0 Procedures

7.1 *Sample analysis*

- 7.1.1 Prior to analysis the samples are thawed and brought to a temperature of between 15° and 30°. Do not let the samples sit for long periods of time as the polyethylene bottles may absorb phosphate.
- 7.1.2 Place 100 ml of sample into a 200 ml polyethylene bottle.
- 7.1.3 To each sample add 10 ± 0.5 ml of the mixed reagent and mix immediately.
- 7.1.4 After 5 minutes and within 2 hours, measure the absorbance of the sample in a 10 cm cell against de-ionized water at a wavelength of 885 nm.

7.2 *Blank determination*

- 7.2.1 A reagent blank is determined by using de-ionized water in place of the 100 ml seawater sample and carrying out the exact method described in section 7.1.
- 7.2.2 The reagent blank should not exceed 0.03. If it does, the ammonium molybdate reagent should be replaced and the blank determination repeated

7.3 *Standardization*

- 7.3.1 *Primary phosphate standard:* Dissolve 0.816 g of anhydrous potassium dihydrogen phosphate, KH_2PO_4 , in 1000 ml of de-ionized water. 1 ml = 6 μmol . Store in a dark bottle. This solution is stable for many months.
- 7.3.2 *Secondary standard:* Dilute 10.0 ml of the primary standard solution to 1000 ml with de-ionized water. 1 ml = 0.06 μmol . Store in a dark bottle. Make fresh every 10 days.
- 7.3.3 Prepare a standard solution of 3.0 μM by diluting 5.0 ml of secondary standard to a volume of 100 ml with de-ionized water. Run these standards as described in section 7.1.

8.0 Calculation and expression of results

8.1 A standardization factor F can be calculated as:

$$F = \frac{3.0 \mu\text{mol/kg}}{E_s - E_b}$$

where:

- 3.0 $\mu\text{mol/kg}$ = concentration of the standard
 E_s = mean absorbance of the standards
 E_b = mean absorbance of the blanks

8.2 The reactive phosphate concentration is calculated by:

$$\text{reactive phosphorus } (\mu\text{mol l}^{-1}) = F \times \text{corrected absorbance}$$

where:

- corrected absorbance = sample absorbance - reagent blank
 F = standardization factor

9.0 References

Strickland, J.D.H., and Parsons, T.R. (1968). Determination of reactive phosphorus. In: *A Practical Handbook of Seawater Analysis*. Fisheries Research Board of Canada, Bulletin **167**, 49–56.

Chapter 12. The Determination of Reactive Silicate in Sea Water

1.0 Scope and field of application

This procedure describes a method for the determination of reactive silicate in seawater. This method is suitable for the assay of oceanic concentrations between $0.1 \mu\text{mol l}^{-1}$ to $140 \mu\text{mol l}^{-1}$. This method is a modification of Strickland and Parsons (1968).

2.0 Definition

The silicate concentration of seawater is given in units of $\mu\text{mol kg}^{-1}$ in seawater.

3.0 Principle of Analysis

The determination of reactive silicate is based on the method of Strickland and Parson (1968). A seawater sample is allowed to react with ammonium molybdate under conditions which result in the formation of silicomolybdate, phosphomolybdate and arsenomolybdate complexes. A reducing agent of metol and oxalic acid is added and silicomolybdate is reduced to a silicomolybdous acid with a blue color, the absorbance of which is measured spectrophotometrically.

4.0 Apparatus

Spectrophotometer

5.0 Reagents

- 5.1 *Molybdate reagent:* Dissolve 4.0 g of reagent quality ammonium paramolybdate, $(\text{NH}_4)_6\text{Mo}_7\text{O}_{24}\cdot 4\text{H}_2\text{O}$ in 300 ml of deionized water. Slowly add 12.0 ml concentrated HCl and mix. Make up volume to 500 ml with deionized water. This solution is stable for many months if stored refrigerated in a polyethylene bottle. Discard if a white precipitant forms.
- 5.2 *Metol-sulphite solution:* Dissolve 6g of anhydrous sodium sulphite, Na_2SO_3 , in 500 ml of deionized water and then add 10 g metol. When the metol has dissolved filter the solution through a No. 1 Whatman filter paper and store it in a glass bottle. This solution should be replaced monthly.
- 5.3 *Oxalic acid solution:* Shake 50 g of reagent grade oxalic acid dihydrate with 500 ml of deionized water. Store the solution in a glass bottle and decant the solution from the crystals for use.
- 5.4 *Sulfuric acid solution:* Dilute 250 ml of concentrated sulfuric acid to 500 ml using deionized water. Cool the solution and store in a glass bottle.

- 5.5 *Reducing reagent:* Mix 100 ml of metol-sulphite solution with 60 ml of oxalic acid solution. Slowly add 60 ml of the 50% sulfuric acid solution and make the solution to a volume of 300 ml with deionized water. This solution should be prepared for immediate use.

6.0 Sampling

- 6.1 Samples are collected on deeper casts after the oxygen, CO₂ and salinity samples have been drawn. Shallow samples (upper 250 m) are collected on the gases cast after oxygen, CO₂, DOC and salinity samples are drawn. An in-line filter (0.8 μm Nuclepore filter) is connected to the Niskin bottle. The spigot is opened and three sets of samples are collected from the water that passes through the filter by gravity filtration. Each bottle is rinsed three times and then filled just below the shoulder. Care must be taken to avoid overfilling of samples to be frozen. These bottles are transferred to a freezer (- 20°C) and kept frozen until analysed.
- 6.2 Contamination is a major problem with nutrient samples, especially near the surface where the ambient concentrations are low. All the nutrient bottles are rigorously cleaned before use. The cleaning begins by a wash with a detergent (Aquet) followed by a rinse with 10% HCl, three rinses with deionized water and a final rinse with de-ionized water.
- 6.3 Prolonged storage of samples is not advised, even if frozen. Sufficient water should be sampled for washing purposes.

7.0 Procedures

7.1 *Sample analysis*

- 7.1.1 All glassware should initially be washed in chromic-sulfuric acid and rinsed well with de-ionized before and after each subsequent use.
- 7.1.2 Sample solutions should be stored at a temperature between 18° and 25°.
- 7.1.3 Add 10 ml of the molybdate reagent to a dry 50 ml measuring cylinder fitted with a stopper.
- 7.1.4 Pipette 25 ml of the sample into the cylinder, stopper, mix the solutions and allow the mixture to stand for 10 minutes.
- 7.1.5 Add the reducing reagent rapidly to make the volume 50 ml and mix immediately.
- 7.1.6 Allow the solution to stand for 2–3 hours then measure the extinction at 810 nm.

7.2 Reagent blank determination

- 7.2.1 The reagent blank is determined using open ocean surface seawater as a sample. Follow the exact procedure outlined in section 7.1. Repeat.
- 7.2.2 A reagent blank should not exceed 0.01 on a 1 cm cell or 0.1 on a 10 cm cell and should be determined for each batch of samples.

7.3 Standardization

- 7.3.1 *Primary silicate standard:* Dissolve 0.9403g dried Na_2SiF_6 in deionized water and make up to 1 liter with DIW. 1 ml = 5 μmol . Store in a dark polypropylene bottle. As with nitrite, ultra pure sodium fluosilicate is difficult to obtain. It may be advisable to compensate for these impurities.
- 7.3.2 Working standards of concentrations of 50, 25, 10 and 5 μM are prepared by diluting 10 ml, 5 ml, 2 ml and 1 ml of primary silicate standard respectively to 1000 ml in open ocean surface seawater. Carry out the exact procedure as described in section 7.2 These solutions should be stored in plastic beakers and used within a few hours.

8.0 Calculation and expression of results

8.1 Standardization Factor, F

- 8.1.1 Subtract the absorbance of the reagent blanks from the absorbance values of the standards. Perform a linear regression of the silicate concentration and the corrected extinction values. The slope of the line is the standardization factor, F . The value of F is typically 100. If a 10 cm cell is used, the F factor may be assumed to be equal to $0.1 \times F_{(1 \text{ cm})}$.
- 8.1.2 F is a function of the salinity of the seawater samples. Between salinities of 25 and 35, the variation may be neglected. The factor F_s at a salinity of S is related to F by:

$$F_s = \frac{F \times (1 + 0.003S)}{1.08}$$

This correction should be used when the salinity varies more than 10 from a value of 28.

8.2 Concentration of reactive silicate ($\mu\text{mol/l}$) = $F \times$ corrected extinction

where:

Corrected absorbance = sample absorbance - blank absorbance

F = standardization factor

9.0 Notes

The silicate and molybdate must combine before the reducing agent is added. Ten minutes is allowed for this reaction. The reducing solution must be added within 30 minutes or else changes in the isomeric form of the silicomolybdate complex will occur.

The sample should be added to the acid molybdate solution instead of the reverse. This prevents unwanted isomeric forms of the silicomolybdate complex.

The time required for the full color development varies with the amount of silicate present in the sample. With a concentration of less than 50 μM , 1 hour is sufficient. For amounts exceeding 75 μM , at least 3 hours should be allowed.

10.0 References

Strickland, J.D.H., and Parsons, T.R. (1968). Determination of reactive silicate. In: *A Practical Handbook of Seawater Analysis*. Fisheries Research Board of Canada, Bulletin **167**, 65–70.

Chapter 13. Measurement of Algal Chlorophylls and Carotenoids by HPLC

1.0 Scope and field of application

Many individual algal pigments or pigment combinations and ratios are taxon-specific. Therefore, analysis of the chlorophylls and carotenoids present in a seawater sample can reveal the taxonomic composition of natural algal populations. This technique allows for the rapid separation of important phytoplankton pigments with detection limits for chlorophylls and carotenoids (using absorbance spectroscopy as analyzed by HPLC) on the order of 1 ng (Bidigare, 1991). The HPLC method described here is a modified version of Wright et al. (1991), provided by Bidigare (in press). Scientists who employ this or other methods to measure pigments should make themselves aware of the current and historical issues that surround these techniques and make appropriate decisions about specific methodologies for their application based on the scientific requirements and constraints of their individual programs.

2.0 Definition

The concentration of all pigments is given as ng kg^{-1} in seawater.

3.0 Principle of Analysis

The reverse phase high performance liquid chromatography method described here separates all the phytoplankton pigments listed below in order of polarity upon passage through a column. The most polar pigments are removed earlier than the less polar pigments.

Chlorophyllide *b*
Chlorophyllide *a*
Chlorophyll *c*₃
Chlorophyll *c*₁+ *c*₂ and Chlorophyll Mg 3,8DVP *a*₅
Peridinin
19' - Butanoyloxyfucoxanthin
Fucoxanthin
19' - Hexanoyloxyfucoxanthin
Prasinolaxanthin
Pyropheophorbide *a*
Diadinoxanthin
Alloxanthin
Diatoxanthin
Lutein
Zeaxanthin
Chlorophyll *b*
Chlorophyll *a*
Phaeophytin *b*

Phaeophytin *a*

α Carotene

β Carotene

Picoplanktonic prochlorophytes are abundant in tropical and subtropical seas and oceans. They contain divinyl-chlorophyll *a* and divinyl-chlorophyll *b* (more appropriately called 8-desethyl, 8-vinyl Chlorophyll), both co-eluting with “normal” chlorophyll *a* and *b* with this reverse phase liquid chromatography technique.

4.0 Apparatus and Reagents

4.1 *Filtration System and Whatman 47 mm GF/F filters*

4.2 *Liquid nitrogen and freezer for storage and extraction*

4.3 *Glass centrifuge tubes for extraction, 15 ml*

4.4 High pressure liquid chromatograph capable of delivering three different solvents at a rate of 1 ml/minute.

4.5 *High-pressure injector valve equipped with a 200 μ L sample loop.*

4.6 *Guard Column (50 x 4.6 mm, ODS-2 C18 packing material, 5 μ m particle size) for extending life of primary column.*

4.7 *Reverse phase HPLC Column (250 x 4.6 mm, 5 μ m particle size, ODS-2 Spherisorb column).*

4.8 *Absorbance detector capable of monitoring at 436 nm, or preferably, an on-line diode array spectrophotometer.*

4.9 *Data recording device: strip chart recorder or, preferably, an electronic integrator or computer equipped with hardware and software for chromatographic data analysis.*

4.10 *Glass syringe, 500 μ l*

5.0 Eluants

Eluant A (80:20, v:v, methanol: 0.5 M ammonium acetate, aq., pH=7.2), eluant B (90:10, v:v, acetonitrile:water), and eluant C (ethyl acetate). Use HPLC-grade solvents, measure volumes before mixing. Filter eluents through a solvent-resistant 0.4 μ m filter before use and de-gas with helium.

The gradient program is listed in Table 13-1.

6.0 Sample Collection and Storage

Water samples are collected from niskins into clean polyethylene bottles with Tygon[®] tubing. Samples are immediately filtered through 47 mm GF/F filters using polycarbonate in-line filter holders (Gelman) and a vacuum of less than 100 mm Hg. Filters are folded in half twice and wrapped in aluminum foil, labeled, and stored in liquid nitrogen (to avoid formation of degradation products) until on-shore analysis. Alternatively, filters can be immediately placed in acetone for pigment extraction if analysis is to be carried out onboard ship. Samples collected for HPLC analysis can also be used in the measurement of chlorophyll *a* and phaeopigments by fluorometric analysis.

Filtration volume will vary with sampling location. For oligotrophic waters, 4 liters are filtered, whereas in coastal regions a smaller volume (0.5-1.0 liters) may be appropriate. In this case, a 25 mm GF/F filter is recommended.

7.0 Procedure

7.1 After removal from liquid nitrogen, the pigments are extracted by placing the filters in 5.0 ml 100% acetone. For 47 mm GF/F filters, 0.8 ml of water is retained on the filter, adjusting the final extraction solution to 86% acetone and the final extraction volume to 5.8 ml. In order to correct for any errors introduced by evaporation or experimental losses, 100 μ l of an internal standard (canthaxanthin in acetone, Fluka) is added to each sample which elutes after zeaxanthin and before chlorophyll *b*. The samples are covered with Parafilm to reduce evaporation, sonicated (0°C, subdued light) and allowed to extract for 4 hours in the dark at -20°C. Following extraction samples are vortexed, filters are pressed to the bottom of the tube with a stainless steel spatula, and centrifuged for 5 minutes to remove cellular debris. External standards are also run before each sample set for daily HPLC calibration.

The addition of 5.0 ml acetone for pigment extraction is necessary to completely submerge 47 mm GF/F filters in 15 ml centrifuge tubes. However, this volume can be altered depending on the sizes of the filter and the extraction tube.

- 7.2 The HPLC system is setup and equilibrated with solvent system A at a flow rate of 1 ml/min.
- 7.3 Samples and standards are prepared for injection by mixing a 1 ml aliquot of the pigment extract with 300 μ l of distilled water in a 2 ml amber vial. Shake and allow to equilibrate for 5 minutes prior to injection.
- 7.4 Approximately 500 μ l of a sample is injected into the 200 μ l sample loop and the three-step solvent program initiated is on closure of the injection valve. The chromatogram is then collected on a recording device.
- 7.5 The identities of the peaks from the sample extracts are determined by comparing their retention times with those of pure standards and algal extracts of known pigment com-

position. Peak identities can be confirmed spectrophotometrically by collecting eluting peaks from the column outlet.

- 7.6 *Calibration:* The HPLC system is calibrated with pigment standards obtained commercially (chlorophylls *a* and *b*, and β -carotene can be purchased from Sigma Chemical Co., and zeaxanthin and lutein from Roth Chemical Co.) and/or by preparative scale HPLC (collecting and purifying HPLC fractions and placing in standard solvents) standards. Concentrations of pigment standards should be determined using a monochromator-based spectrophotometer in the appropriate solvents prior to the calibration of the HPLC system. The recommended extinction coefficients for most of the common algal pigments are provided in Table 13-2 (Bidigare 1991). Pigment standard concentrations are calculated as follows:

$$C_s = \frac{(A_{\max} - A_{750\text{nm}})}{E \times l} \times \frac{1000\text{mg}}{1\text{g}}$$

where:

- C_s = pigment concentration (mg l^{-1})
 A_{\max} = absorbance maximum (Table 2)
 $A_{750\text{ nm}}$ = absorbance at 750 nm to correct for light scattering
 E = extinction coefficient ($\text{L g}^{-1} \text{cm}^{-1}$, Table 2)
 l = cuvette path length (cm)

Standards stored under nitrogen in the dark at -20°C are stable for approximately one month.

After determining the concentrations of the pigment standard they are injected onto an equilibrated HPLC system to calculate standard response factors (RF). Response factors are calculated as weight of standard injected (determined spectrophotometrically) divided by the area of the pigment standard plus areas of structurally related isomers, if present.

8.0 Calculation and expression of results

Concentration of the individual pigments in the sample are calculated using the following formula:

$$C_i = (A) \times (RF) \times \left(\frac{1}{IV}\right) \times (EV) \times \left(\frac{1}{SV}\right)$$

where:

- C_i = individual pigment concentration (ng per liter)
 A = integrated peak area
 RF = standard response factor
 IV = injection volume
 EV = extraction volume with internal standard correction

SV = sample volume

The units of ng kg^{-1} can be obtained by dividing this result by the density of the seawater.

9.0 References

- Bidigare, R. (1991). in Spencer and Hurd (eds.). The analysis and characterization of marine particles. American Geophysical Union, Washington D.C.
- Herbland, A., A. Le Bouteiller, and P. Raimbault. (1985). Size structure of phytoplankton biomass in the equatorial Atlantic Ocean. *Deep-Sea Res.* **32**:819-836.
- Holm-Hansen, O., and B. Riemann. (1978). Chlorophyll *a* determination: improvements in methodology. *Oikos*, **30**: 438-447.
- Wright, S.W., S.W. Jeffrey, F.C. Mantoura, C.A. Llewellyn, T. Bjørnland, D. Repeta, and N. Welschmeyer (1991). Improved HPLC method for the analysis of chlorophylls and carotenoids from marine phytoplankton. *Mar. Ecol. Prog. Ser.* **77**:183-196.

Table 13-1. HPLC solvent system program.

Time	Flow Rate	%A	%B	%C	Conditions
0.0	1.0	100	0	0	Linear gradient
2.0	1.0	0	100	0	Linear gradient
2.6	1.0	0	90	10	Linear gradient
13.6	1.0	0	65	35	Linear gradient
18.0	1.0	0	31	69	Hold
23.0	1.0	0	31	69	Linear gradient
25.0	1.0	0	100	0	Linear gradient
26.0	1.0	100	0	0	Hold
34.0	1.0	100	0	0	Inject

Table 13-2:

Pigment	Wavelength (solvent)	E 1cm(L g ⁻¹ cm ⁻¹)
Chlorophyll <i>a</i>	664 nm (90% acetone)	87.67
Chlorophyll <i>b</i>	647 nm (90% acetone)	51.36
Chlorophyll <i>c</i> ₁ + <i>c</i> ₂	631 nm (90% acetone)	42.6
Chlorophyllide <i>a</i>	664 nm (90% acetone)	128.0
Fucoxanthin	449 nm (EtOH)	160.0
19' - Hexanoyloxyfucoxanthin	447 nm (EtOH)	160.0
19' - Butanoyloxyfucoxanthin	446 nm (EtOH)	160.0
Lutein	445 nm (EtOH)	255.0

Zeaxanthin	450 nm (EtOH)	254.0
Prasinoxanthin	454 nm (EtOH)	160.0
Alloxanthin	453 nm (EtOH)	262.0
Peridinin	472 nm (EtOH)	132.5
Diadinoxanthin	446 nm (EtOH)	262.0
Diatoxanthin	449 nm (EtOH)	262.0
β Carotene	453 nm (EtOH)	262.0
Phaeophorbide <i>a</i>	665 nm (90% acetone)	69.8
Phaeophytin <i>a</i>	665 nm (90% acetone)	49.5

Chapter 14. Measurement of Chlorophyll *a* and Phaeopigments by Fluorometric Analysis

1.0 Scope and field of application

Chlorophyll *a* measurements have historically provided a useful estimate of algal biomass and its spatial and temporal variability. The fluorometric method is extensively used for the quantitative analysis of chlorophyll *a* and phaeopigments. However, errors can be introduced into the results when chlorophylls *b* and/or chlorophylls *c* are present. Chlorophyll *b* is the main source of error in this method. While generally not abundant in surface waters, chlorophyll *b* can be as high as 0.5 times the chlorophyll *a* concentration in the deep chlorophyll maximum, causing slight underestimations of the chlorophyll *a* concentration, and drastic overestimations of the phaeopigment concentrations. Divinyl-chlorophyll *a* also interferes and is taken as chlorophyll *a* by this method. The procedure described here is appropriate for all levels of chlorophyll *a* concentration in the marine environment. Filtration volumes should be modified for the different environments. Scientists who employ this or other methods to measure pigments should make themselves aware of the current and historical issues that surround these techniques and make appropriate decisions about specific methodologies for their application based on the scientific requirements and constraints of their individual programs.

2.0 Definition

The concentrations of chlorophyll *a* and phaeopigments in seawater are given as $\mu\text{g kg}^{-1}$.

3.0 Principle of Analysis

Algal pigments, particularly chlorophyll *a*, fluoresce in the red wavelengths after extraction in acetone when they are excited by blue wavelengths of light. The fluorometer excites the extracted sample with a broadband blue light and the resulting fluorescence in the red is detected by a photomultiplier. The significant fluorescence by phaeopigments is corrected for by acidifying the sample which converts all of the chlorophyll *a* to phaeopigments. By applying a measured conversion for the relative strength of chlorophyll and phaeopigment fluorescence, the two values can be used to calculate both the chlorophyll *a* and phaeopigment concentrations.

4.0 Apparatus

4.1 Filtration system and Whatman GF/F filters

4.2 Liquid nitrogen and freezer for storage and extraction

4.3 Glass centrifuge tubes for extraction, 15 ml

4.4 Turner fluorometer, fitted with a red sensitive photomultiplier, a blue lamp, 5-60 blue filter and 2-64 red filter.

5.0 Reagents

- 5.1 100% acetone
- 5.2 90% acetone
- 5.3 1.2M HCl (100 ml HCl in 900 ml de-ionized water)

6.0 Sample Collection and Storage

Water samples are collected from niskins into clean polyethylene bottles with Tygon[®] tubing. Samples are immediately filtered through 47 mm GF/F filters using polycarbonate in-line filters (Gelman) and a vacuum of less than 100 mm Hg. Filters are folded in half twice and wrapped in aluminum foil, labeled, and stored in liquid nitrogen (to avoid formation of degradation products) until shore analysis. Alternatively, filters can be placed immediately in acetone for pigment extraction if analysis is to be carried out onboard ship.

In oligotrophic waters, for this measurement coupled with HPLC determined pigments, 4 liters are filtered. For fluorometric analysis alone, a smaller volume (0.5 -1.0 l) may be sufficient. In coastal regions, a volume of 0.1-0.5 l may be adequate. In this case, use of 25 mm GF/F filters may be appropriate.

7.0 Procedure

- 7.1 After removal from liquid nitrogen or freezer), the pigments are extracted by placing the filters in 5.0 ml 100% acetone. For 47 mm GF/F filters, 0.8 ml of water is retained adjusting the final extraction solution to 86% acetone and the final extraction volume to 5.8 ml. The samples are covered with Parafilm to reduce evaporation, sonicated (0°C, subdued light) and allowed to extract for 4 hours in the dark at -20°C. Following extraction, samples are vortexed, filters are pressed to the bottom of the tube with a stainless steel spatula and spun down in a centrifuge for 5 minutes to remove cellular debris. For fluorometric analysis (not HPLC), decantation can replace centrifuging.
 - 7.1.1 The addition of 5.0 ml acetone for pigment extraction is necessary to completely submerge 47 mm GF/F filters in 15 ml centrifuge tubes. This volume may be altered depending on the size of the filter and volume of the extraction tube.
- 7.2 The fluorometer is allowed to warm up and stabilize for 30 minutes prior to use.
- 7.3 The fluorometer is zeroed with 90% acetone.
- 7.4 1.0 ml of pigment extract is mixed with 4.0 ml 90% acetone in a cuvette and read on the appropriate door to give a reading between 30 and 100. The sample is then acidified

with 2 drops of 1.2 M HCl. Further dilutions may be necessary for higher chlorophyll *a* concentrations.

7.5 Standardization

7.5.1 For laboratory use, the fluorometer is calibrated every 6 months with a commercially available chlorophyll *a* standard (*Anacystis nidulans*, Sigma Chemical Company). If the fluorometer is taken to sea, it is recommended that the fluorometer be calibrated before and after each cruise.

7.5.2 The standard is dissolved in 90% acetone for at least 2 hours and its concentration (mg l^{-1}) is calculated spectrophotometrically as follows:

$$\text{chl } a = \frac{(A_{\text{max}} - A_{750\text{nm}})}{E \times l} \times \frac{1000\text{mg}}{1\text{gram}}$$

where:

A_{max}	=	absorption maximum (664 nm)
$A_{750\text{ nm}}$	=	absorbance at 750 nm to correct for light scattering
E	=	extinction coefficient for chl <i>a</i> in 90% acetone at 664 nm ($87.67\text{ L g}^{-1}\text{ cm}^{-1}$)
l	=	cuvette path length (cm)

7.5.3 From the standard, a minimum of five dilutions are prepared for each door. Fluorometer readings are taken before and after acidification with 2 drops 1.2 M HCl.

7.5.4 Linear calibration factor (K_x) are calculated for each door (*x*) as the slope of the unacidified fluorometric reading vs. chlorophyll *a* concentration calculated spectrophotometrically.

7.5.5 The acidification coefficient (F_m) is calculated by averaging the ratio of the unacidified and acidified readings (F_o/F_a) of pure chlorophyll *a*.

7.5.6 Samples are read using a door setting that produces a dial reading between 30 and 100. The fluorometer is zeroed with 90% acetone each time the door setting is changed.

8.0 Calculation and expression of results

The concentrations of chlorophyll *a* and phaeopigments in the sample are calculated using the following equations:

$$\text{Chl } (\mu\text{g/l}) = \left(\frac{F_m}{F_m - 1} \right) \times (F_o - F_a) \times K_x \times \left(\frac{\text{vol}_{\text{ex}}}{\text{vol}_{\text{filt}}} \right)$$

$$\text{Phaeo (chl equiv. weights)} = \left(\frac{F_m}{F_m - 1} \right) \times [(F_m \cdot F_a) - F_o] K_x - \text{vol}_{\text{ex}}$$

where:

F_m = acidification coefficient (F_o/F_a) for pure Chl *a* (usually 2.2).

F_o = reading before acidification

F_a = reading after acidification

K_x = door factor from calibration calculations

vol_{ex} = extraction volume

vol_{filt} = sample volume

9.0 References

- Herbland, A., A. Le Bouteiller, and P. Raimbault. (1985). Size structure of phytoplankton biomass in the equatorial Atlantic Ocean. *Deep-Sea Res.*, **32**: 819-836.
- Holm-Hansen, O., and B. Riemann. (1978). Chlorophyll *a* determination: improvements in methodology. *Oikos*, **30**: 438-447.

Chapter 15. Determination of Particulate Organic Carbon and Particulate Nitrogen

1.0 Scope and field of application

This procedure describes a method for the determination of particulate organic carbon and particulate nitrogen in seawater. The assay is appropriate for measuring oceanic levels of particulate organic carbon (5.0 - 500.0 $\mu\text{g C/kg}$) and particulate nitrogen (0.5 - 100.0 $\mu\text{g N/kg}$). The principles for this method were first described by Gordon (1969) and Kerambrun and Szekiolda (1969). Sharp (1974) describes a number of useful modifications to the existing method applied here. Detailed description of the analytical procedure is given by the manufacturer (Control Equipment Corporation 1988). Some of the details of the actual measurement of carbon and nitrogen in this method are specific to the Control Equipment Corporation (CEC) 240-XA Elemental Analyzer hardware used at the Bermuda Atlantic Time-series Study. Scientists who employ this or other methods to measure POC and PN should make themselves aware of the current and historical issues that surround these techniques and make appropriate decisions about specific methodologies for their application based on the scientific requirements and constraints of their individual programs.

2.0 Definition

2.1 The concentration of particulate organic carbon is given in $\mu\text{g C/kg}$ seawater.

2.2 The concentration of particulate nitrogen is given in $\mu\text{g N/kg}$ seawater.

3.0 Principle of Analysis

A dried, acidified sample of particulate matter is combusted at 960°C. The organic carbon is converted to CO_2 and the nitrogen oxides are subsequently reduced to N_2 gas. Both gases are measured by thermal conductivity.

4.0 Apparatus

4.1 *Control Equipment Corporation (CEC) 240-XA Elemental Analyzer* (Leeman Labs, Inc.)

4.2 CAHN Model 4400 Electrobalance

4.3 Hewlett Packard (HP-150) Analytical Software

5.0 Reagents

5.1 *Hydrochloric acid* (concentrated HCl: reagent grade)

5.2 *Acetanilide* (reagent grade): Acetanilide has 0.7109 g C and 0.1036 g N per g total mass.

6.0 Sampling

The POC/PN samples are taken after oxygen, CO₂, salinity and nutrient samples have been removed, approximately 30–60 minutes after the CTD/rosette reaches the surface. Settling of large particles in the Niskin bottles will create a non-uniform distribution of the particles within this period of time. For best results, the Niskin bottle should therefore be shaken before sampling or the entire volume filtered (including the volume below the spigot).

Samples are collected in 4 liter polypropylene bottles equipped with a 1/4" outlet at the base. The filtration is "in-line" with the filter mounted in a Delrin filter holder. The holder is connected to the outlet at the bottom of the 4 liter bottle on one end and a vacuum system (liquid container and pump) on the other. Two liters are normally filtered at all depths (although this volume may not be adequate for all systems) from surface to 1000 m onto precombusted (450°C, 5 hours) 25 mm Whatman GF/F filters (nominal pore size 0.7 µm). The filter is removed, wrapped in precombusted aluminum foil and stored frozen in a deep freezer (-20°C) until processed.

7.0 Procedures

7.1 *Sample Analysis*

7.1.1 Prior to analysis, the filters are thawed, allowed to dry overnight at 65°C in acid washed and precombusted (450°C, 2 hours) scintillation vials and then placed overnight in a desiccator saturated with HCl fumes. The air in the desiccator is kept saturated by leaving concentrated HCl in an open container in the lower compartment of the desiccator. Thereafter, the filters are dried again at 65°C and packed in precombusted (850°C, 1 hour) nickel sleeves.

7.1.2 The samples are analyzed on a Control Equipment Corporation (CEC) 240-XA Elemental Analyzer following the guidelines given by the manufacturer. Sixty-four samples are run at a time on the auto-sampler, of which one is a standard (see below) and approximately nine are Ni sleeve blanks. The machine operator checks on the machine regularly to ensure that problems have not developed. Data are collected and stored by a microcomputer automatically.

7.2 *Standardization and blank determination*: Acetanilide standard and blanks (empty Ni sleeves) are measured prior to each batch run of samples (64 samples). A minimum of three empty filters are processed as an ordinary sample and analysed for each cruise as filter blanks. The acetanilide standard is weighed in acetone washed tin capsules on a CAHN Electrobalance. Standard weights are usually between 0 and 2.0 mg. The tin capsule with the standard is put into a nickel sleeve and run on the Elemental Analyzer. The empty filter blanks should be treated exactly like sample filters except that no sample water is passed through them.

8.0 Calculation and expression of results

The POC and PN weights of each of the samples are integrated and estimated automatically by the Hewlett Packard (HP-150) Analytical Software, supplied with the CEC instrument. The program automatically includes the latest Ni sleeve blank into its calculations. The *in-situ* concentration is estimated:

$$\mu\text{g/kg} = \frac{S - B}{V \rho}$$

Where:

- S = the result for the filtered sample
- B = the measured filter blank
- V = volume filtered (liters)
- ρ = density (a function of T, S and P, where T = model temperature at filtration, S = salinity of the sample, and P = atmospheric pressure)

9.0 References

- Control Equipment Corporation. (1988). The automated and advanced Model 240-XA Elemental Analyzer. Lowell, MA.
- Gordon, Jr. D.C. (1969). Examination of methods of particulate organic carbon analysis. *Deep-Sea Research* **16**:661-665.
- Kerambrun, P. and K.H. Szekiolda. (1969). Note technique. *Tethys* **1**:581-584.
- Sharp, J.H. (1974). Improved analysis for "particulate" organic carbon and nitrogen from seawater. *Limnology and Oceanography* **19**:984-989.

Chapter 16. Determination of Dissolved Organic Carbon by a High Temperature Combustion/Direct Injection Technique

1.0 Scope and field of application

This protocol describes a high temperature combustion/direct injection (HTC/DI) technique for the determination of dissolved organic carbon (DOC) in seawater, suitable for the assay of concentrations of DOC (30-300 $\mu\text{mol C/kg}$).

2.0 Definition

The DOC content of seawater is defined as the total concentration of all non-volatile organic substances expressed as moles of C per kilogram of seawater. An alternate and equivalent definition for the DOC content of seawater is the number of moles of carbon dioxide produced when all of the non-volatile organic substances are fully oxidized. For example, if a sample contained 60 μmol of glucose per kilogram, then the DOC content would be 360 $\mu\text{mol C/kg}$.

3.0 Principle of analysis

This method of analysis is based upon the complete oxidation of organic compounds to carbon dioxide followed by quantitative measurement of the CO_2 produced by non-dispersive infra-red (NDIR) analysis. This technique was first attempted for seawater by Sharp (1973) upon modification of a procedure developed by Van Hall *et al.* (1963) for fresh water. Interferences from the particulate carbon and inorganic carbon in seawater are first removed by filtration through glass fiber filters and sparging with CO_2 -free gas after acidification of the sample (Sharp and Peltzer, 1993).

The instrument response is calibrated by the method of standard additions. Known amounts of organic compounds are added to produce a series of solutions with consistently increasing concentrations of organic carbon. The slope of the regression line obtained when peak area is plotted against the amount of carbon added is the instrument response factor. Both distilled water and seawater solutions have been used for this calibration. The principle is the same although the calculations are slightly different. (See section 8.3 below).

The instrument blank is determined by injecting the identical volume used during sample analysis and measuring the peak area. The peak area represents the amount of CO_2 liberated from the catalyst/combustion tube upon injection of a liquid sample and so each injection must be corrected by subtraction of this amount. It is important that the water used for this purpose be as carbon-free as possible (otherwise over-correction will occur and the DOC concentration will be under-estimated) and that this measurement be repeated throughout the analytical sequence to closely monitor the instrument blank which may vary over time and use. Until a universally available source of carbon-free seawater (CFSW) is developed, carbon-free distilled water (CFDW) is recommended.

4.0 Apparatus

- 4.1 *Filtration apparatus:* In cases where POC levels are high ($>2 \mu\text{mol C/kg}$), the samples need to be filtered to avoid interference with the DOC determination. Samples are filtered through a Whatman GF/F glass fiber filter using an in-line filter holder. Samples can be either gravity filtered directly from the Niskin bottle or pressured filtered at < 3 psig. Samples should not be vacuum filtered as this often results in low level contamination.
- 4.2 *Sparging apparatus:* After filtration and acidification, samples are sparged to remove $> 99.95\%$ of the inorganic carbon. For small volume samples ($< 40 \text{ mL}$) samples can be sparged by bubbling CO_2 free gas (oxygen or nitrogen) through a fine teflon line (spaghetti tubing) placed directly in the sample to almost the vessel bottom. A flowrate of $100\text{--}20 \text{ mL/min}$ for 6–8 minutes is usually sufficient to remove all inorganic carbon. For larger samples, a polyethylene frit on the end of a 3mm diameter teflon tube aids in the production of fine bubbles. For 80–100 mL samples a flowrate of 500 mL/min for 5–6 minutes is usually sufficient. Each investigator should check the efficiency of their sparging system by re-sparging several samples. A consistent decrease of $> 1 \mu\text{mol C/kg}$ after re-sparging indicates insufficient sparging during the first time period.
- 4.3 *DOC analyzer:* Several versions of HTC/DI analyzers have been built, either commercially or “homemade”. Each of these consists of a furnace and gas processing stream containing the following **essential** components:
 - 4.3.1 Source of CO_2 -free carrier gas (preferably oxygen although nitrogen has been used) delivered through a pressure regulator with a stainless steel diaphragm.
 - 4.3.2 High temperature combustion furnace.
 - 4.3.3 Syringe to inject the seawater sample.
 - 4.3.4 Trap to remove HCl and SO_2 .
 - 4.3.5 Aerosol filter.
 - 4.3.6 NDIR CO_2 analyzer.
 - 4.3.7 Peak area integrator

5.0 Reagents

5.1 Gases

- 5.1.1 *Oxygen:* Ultra-high purity or zero-grade oxygen may be used for sparging and as the carrier gas for the DOC analyzer. The gas may contain at most 1 ppm total hydrocarbons and 1 ppm CO_2 . Typically, the UHP gas is listed as $>99.993\%$, the zero-grade gas as $>99.6\%$ —it contains some nitrogen. Both

gases should be passed through a drying trap filled with ascarite for final removal of CO₂ immediately prior to use.

- 5.1.2 *Nitrogen*: Ultra-high purity or zero-grade nitrogen may be used for pressure filtration. The gas should contain at most 1 ppm total hydrocarbons and 1 ppm CO₂. Typically, the UHP gas is listed as > 99.998%. The gas is passed through a drying trap filled with ascarite for final removal of CO₂ immediately prior to use.

5.2 *Dry chemicals*

- 5.2.1 *Ascarite*: Thomas Scientific, Swedesboro, NJ.

- 5.2.2 *Magnesium perchlorate* (anhydrous): Fisher Chemical Co., Pittsburgh, PA.

- 5.2.3 *Soda lime* (4-8 mesh). Fisher Chemical Co.

5.3 *Solutions*

- 5.3.1 *50% (w/w) phosphoric acid*: Prepared by diluting the nominally 85% (w/w) concentrated acid (Fisher Chemical Co.) with CFDW.

- 5.3.2 *AgNO₃/H₃PO₄*: Mix 5 g of AgNO₃ (Fisher Chemical Co.) with 95 g 10% H₃PO₄.

- 5.3.3 *KHP stock solution*: 4 mM potassium hydrogen phthalate (Aldrich Chemical Company, Milwaukee, WI) in CFDW.

- 5.3.4 *30% (w/w) hydrogen peroxide*: Fisher Chemical Co.

- 5.3.5 *10% (w/v) sodium hydroxide*: Mallinckrodt Specialty Chemicals Co., Paris, Kentucky.

- 5.3.6 *0.1N hydrochloric acid*: prepared from doubly distilled azeotrope.

6.0 **Sampling**

6.1 *Sample bottle preparation*

- 6.1.1 100 mL "Boston rounds": Soak bottles overnight in room-temperature 10% NaOH. Drain, rinse three times with distilled water, three more times with 0.1N HCl and finally three times with distilled water. Oven dry overnight at 150°C. The green caps with integral teflon liners are cleaned by soaking for one hour or more in distilled water, rinsed with same then air dried. The removable teflon liners (which are added to the caps when dry) are cleaned by rinsing with distilled water, sonicating three times with acetone for fifteen minutes followed by three more ultra-sonic treatments with dichloromethane. The liners are then rinsed with dichloromethane and oven dried at 150°C overnight.

- 6.1.2 40 mL “EPA vials”: Rinse each 40 mL vial three times with distilled water to remove dust and other fine particles. After air-drying, place in muffle furnace at 500°C overnight (12-16 hrs) then cool. Cap with green caps when cool. The green caps with integral teflon liners are cleaned by soaking for one hour or more in distilled water, rinsed with same then air dried. The removable teflon liners (which are added to the caps when dry) are cleaned by rinsing with distilled water, sonicating three times with acetone for fifteen minutes followed by three more ultra-sonic treatments with dichloromethane. The liners are then rinsed with dichloromethane and oven dried at 150°C overnight.
- 6.2 *Niskin bottles*: Use of “well-aged” Niskin bottles is recommended. Replace all O-rings with silicone ones and use either teflon coated stainless steel springs or heavy-walled silicone tubing. The stopcocks may be nylon, polypropylene or teflon but not PVC. The bottles should be free of oil and dirt and rinsed thoroughly with fresh water before the ship leaves port. At a test station or at the first station, the bottles should be well rinsed with seawater. Repeated lowerings and firings at 1-2000 m is recommended.
- 6.3 *Drawing of samples*: DOC samples are easily contaminated with organic compounds adsorbed from the air, from fingerprints or on the sampling ports. In order to keep the sampling ports as clean as possible for these samples, no Tygon[®] or phthalate containing tubing may be used in connection with the sampling ports prior to drawing the DOC samples. Ideally, DOC samples should be drawn first, and if not first, then immediately following the gas samples. The sample should be allowed to flow freely from the Niskin bottle for a few seconds to clean the port. No transfer tubing is necessary. The sample bottle should not be allowed to contact the sampling port, rather the sample should flow through a few cms of air before entering the bottle. The bottles and caps are rinsed three times with a small volume of sample and then the bottle is immediately filled. Allow a sufficient headspace for sparging the sample.
- 6.4 *Sample acidification*: For open ocean seawater samples of 35ppt salinity, 5 μL of 50% H_3PO_4 should be added per mL of sample. The acid may be added immediately after the sample is drawn (if a clean environment for this work is available) or one may wait the 20-30 minutes required to sample the whole hydrocast, then acidify all the samples at the same time in the lab. Unless drawing the sample or acidifying, the bottles should be tightly capped at all times to avoid contamination of the samples from the ship's stack gases or fuel vapors.
- 6.5 *Sample storage*:
- 6.5.1 *Refrigeration for short-term*: Unless the samples will be analyzed immediately, they should be refrigerated at 2-4°C until analyzed immediately after acidification. This type of storage is acceptable for time periods ranging from a few hours to several months.
- 6.5.2 *Freezing for long-term*: If the samples are not to be analyzed during the course of the cruise, they should be frozen until time of analysis for best keeping. Immediately after acidifying, the samples should be placed in an aluminum

block (specifically bored-out to maintain a tight fit with the sample vials) cooled to -20°C to achieve a rapid cooling of the samples. After one hour, the samples should be checked to see if they are frozen. Super-cooling often occurs. In this case a quick twist of the vial often encourages immediate solidification of the sample with little or no brine formation. Once frozen, samples may be moved to a cardboard container for storage at -20°C . Samples should be kept frozen until analysis. Avoid thawing and slow re-freezing of the samples as this encourages fractionation of the samples and brine formation.

7.0 Procedures

7.1 *CFDW preparation*: Carbon-free distilled water (CFDW) can be prepared by a variety of methods. However, no method is refined to the point that guarantees a DOC level below a certain limit. Thus it is imperative that the analyst continually check the quality of his blank water, maintain suitable quality control charts, and crosscheck with other sources and analysts.

7.1.1 *UV- H_2O_2 method*: Low DOC water ($<20\ \mu\text{MC}$)—either distilled, Milli-Q or reverse osmosis— is placed inside a one liter Quartz flask. One mL of 30% H_2O_2 is added and the solution tightly capped with a quartz stopper. The flask is then placed in direct sunlight on a cloudless day for 8-10 hours. This process is repeated 3-4 times, or until the instrument blank “levels-off”. Then the irradiation process is repeated once more **without** the additional H_2O_2 . After several days this solution becomes saturated with oxygen so one must be careful not to vigorously shake the solution. It is also a good idea to relieve the internal pressure from time to time.

7.1.2 *Redistillation from persulfate*: Very low DOC water ($< 4\ \mu\text{MC}$, comparable to the UV- H_2O_2 oxidized CFDW) can be prepared by redistillation from persulfate. Milli-Q water is further purified by reverse osmosis then distilled in an all-glass still. This water is then re-distilled in 1L batches after addition of 1g $\text{K}_2\text{S}_2\text{O}_8$ and 1 mL 85% H_3PO_4 per liter of water (see Benner and Strom, 1993).

7.1.3 *Milli-Q*. Some Milli-Q systems are capable of achieving comparable quality water straight-away. However, this can only be verified by comparison against other sources and long-term reference solutions. Continual quality control is a must when this source of CFDW is used.

7.2 *Standard preparation*:

7.2.1 *Distilled water standards*: A series of reference solutions with a step-interval of approximately $32\ \mu\text{MC}$ are prepared by sequential addition of the 4 mM KHP standard stock solution to 100 mL of distilled water. Add 0, 100, 200, 300, 400 and 500 μL of the standard stock solution to six 100 mL volumetrics. Fill to volume with the same CFDW used to make the reference water. To each add 500

μL of 50% H_3PO_4 . Seal and store at 4°C . The exact concentration of the standards can be calculated directly from the concentration of the stock solution:

$$\text{DOC}(\mu\text{MC}) = ((\text{vol std} \times \text{con. stock solution}) / 100\text{ml})$$

7.2.2 A series of seawater based reference solutions with a step-interval of approximately $32 \mu\text{MC}$ are prepared by sequential addition of the 4 mM KHP standard stock solution to 100 mL aliquots of seawater water. It is best to use deep ocean seawater ($> 1000\text{m}$) or well filtered and aged surface water. Weigh out the equivalent of 100 mL of seawater (mass = $100 \text{ mL} \times \text{density at lab temperature}$ —calculate density from measured salinity) into six 100 mL bottles. Add $0, 100, 200, 300, 400$ and $500 \mu\text{L}$ of the standard stock solution to the bottles in order. To each add $500 \mu\text{L}$ of 50% H_3PO_4 . Seal and store at 4°C . The exact concentration of the standards can be calculated from the concentration of the stock solution and the background DOC concentration as described below in section 8.3.2.

7.3 *Blank determination:* It is essential that all peak area measurements are corrected for the instrument blank. In order to do this, a CFDW sample is injected at regular intervals throughout the day's analysis run (see section 7.5). Typically, three injections of the blank water sample are made at a regular time interval (usually 4-5 mins). This water is acidified and sparged in the same fashion as the samples.

7.4 *Response factor determination:* There are two ways to determine the instrument response factor. The first involves running the complete set of standard solutions. Generally, this method is used only when a few or no samples are to be run that day due to its time-consuming nature. The second involves running only two standards (high and low) spanning the range of concentrations expected for that days run. Typically, this method is used when a large number of unknown samples are to be run that day. The standards are then run **both** at the beginning and the end of the days run (see section 7.5).

7.4.1 *Standard addition series:* After running 3 or 4 warm-up samples (three injections of each) and a CFDW blank, the complete set of the standard addition series is run—again, three injections of each. Finally, a CFDW blank is run. The response factor is calculated as per the method in section 8.3.1 for distilled water or 8.3.2 for seawater based standards.

7.4.2 *Two-point determination:* When a large number of samples are to be run, a two-point calibration is practical. The two standards should bracket the extremes of that day's runs. There should be a difference in concentration between the two of $60\text{-}120 \mu\text{MC}$ for typical open ocean samples. The two standards should be bracketed by CFDW samples to observe and correct for any change in instrument blank. This calibration is done twice: Once at the beginning of the day's run and once at the end. By repeating the calibration at both the beginning and end of the day's run it is possible to tell if the instrument response factor was drifting during the day and to correct for any drift observed.

- 7.4.3 *CO₂ gas standard calibration*: Both of the proceeding methods assume that complete oxidation of the added standard is occurring. In order to verify this, one can by-pass the uncertainty of the oxidation step by injecting CO₂ in air standards. These should be obtained from a reliable source (e.g. in the U.S., NIST) with the concentration known to a precision of $\pm < 1$ ppm. Calibrate the instrument response by injecting (in triplicate) a series of **volumes** then plot mean peak areas versus moles of CO₂ injected divided by your nominal injection volume. Remember that CO₂ is not an ideal gas so the Van der Waals equation of state must be used to calculate the number of moles injected from the observed volume and room temperature and pressure. The slope of this line should be identical with your normal calibration.
- 7.5 *Analytical protocol*: A typical day's run consists of 3-4 warm-up seawater samples, a CFDW blank, a calibration set, a series of samples run in groups of 4-6 with CFDW blanks interdispersed, a CFDW blank, a second calibration set and a CFDW blank. The warm-up seawater samples are run to minimize and stabilize the instrument background/blank. The same sample is run repeatedly so it will be possible to see if the instrument blank has stabilized. If the instrument is still drifting after 4 samples, run a few more until a repeatable signal is obtained for the warm-up sample before beginning the high-low calibration set.
- 7.6 *Sample injection*: All samples (warm-up, CFDW, calibration, or unknown) are injected in triplicate. Samples are first sparged with CO₂-free gas (see section 4.2) then the syringe is filled. First, rinse the syringe three times with sample, discarding each rinse, then over-fill the syringe. Invert to expel all air bubbles and express excess sample. The sample is then injected into the furnace. Different instruments have different procedures but a common thread is the injection of samples at regular time intervals to minimize instrument background/blank variation. While making one run, sparge the sample for the next analysis. All NDIR data is digitized and recorded by computer.
- 7.7 *Post-Analysis*: Following the sample analysis runs, a recalibration sequence and CFDW blanks must be done. Finally, the CFDW used for the day's run is compared with the long-term standard to check for drift/contamination. The data are reprocessed according to the equations in section 8.

8.0 Calculation and Expression of Results

- 8.1 *Peak Screening*: Before calculating the mean corrected peak area for each sample, it is imperative that the peak integration be verified. Check that the integration baseline is correct—intercepting the middle of the baseline noise at both the beginning and end of each peak. Reject peak areas (or re-integrate peaks) where improper baseline is observed, poor or irregular peak shape is observed or there is other indications of a bad injection. Average all acceptable peaks for each sample or blank run.
- 8.2 *Blank Correction*: Early in the lifetime of the combustion tube, the instrument blank tends to slowly decrease. In these cases, interpolate the instrument blank between CFDW runs to blank correct the sample runs. Use a simple linear interpolation. Later in

the combustion tube lifetime, the instrument blank can be stable. On these days, average the instrument blank over the course of the days run. Calculate the mean corrected peak area by subtracting the appropriate instrument blank.

8.3 *Response factor determination*

8.3.1 *Distilled water standard addition series:* Plot the mean corrected peak area as a function of the concentration of the distilled water standard. Fit a linear regression to the points. The slope of the line is the instrument response factor in area units per micromole.

8.3.2 *Seawater based standard addition series:* Because the seawater used to make the seawater-based standard addition series contains DOC, one must do the calculation twice. The first pass determines the background DOC level, the second pass to determine the concentration of each standard. First plot the mean corrected peak areas vs. the amount of DOC added calculated by the following formula:

$$\text{DOC - add } (\mu\text{MC}) = \frac{(\text{vol. std} \times \text{conc. stock solution})}{((\text{mass of seawater}/\text{density}) + \text{vol. std.} + \text{vol. acid})}$$

Fit a linear regression to the points. The slope of the line is the instrument response factor in area units per micromole. The DOC background can be calculated from the y-intercept:

$$\text{Background DOC} = y - \text{intercept}/\text{slope}$$

Now the exact concentration of each standard can be calculated taking into account the DOC background and the acid+std. dilution effect:

$$\text{DOC } (\mu\text{MC}) = \frac{(\text{vol. std.} \times \text{conc. stock solution}) + (\text{bkgrd} \times \text{mass of seawater}/\text{density})}{((\text{mass of seawater}/\text{density}) + \text{vol. std.} + \text{vol. acid})}$$

Now re-plot the mean corrected peak areas vs. the actual concentration of the standard solutions. Fit a linear regression to the points. The slope of the line is the instrument response factor in area units per micromole. Note that this slope includes an adjustment for the amount of acid added. To accurately determine the sample concentrations, they will need to be corrected for the amount of acid added (see section 8.4.4).

- 8.3.3 *Two-point determination:* After running the two standards, correct their mean areas for the instrument blank, then calculate the instrument response factor:

$$\text{slope} = \frac{\text{mean net area (high-standard)} - \text{mean net area (low-standard)}}{\text{conc (high-standard)} - \text{conc (low-standard)}}$$

This calibration is done twice daily. Differences between the morning and afternoon calibrations greater than 3% of the mean calibration mean that the instrument calibration is drifting and the response factor must be interpolated for that day's run (Section 8.4.2, below). Differences of less than 3% are most likely due to noise. Calculate the average of the two response factors.

8.4 Sample analysis

- 8.4.1 *Blank determination:* Plot the mean area for each of the day's CFDW runs (in area units) versus run number. If no trend is apparent, then the mean of that day's CFDW runs should be calculated. Otherwise, to determine the blank, a simple linear interpolation is generally sufficient. For example, find the difference between two successive blanks, count the number of runs in between and divide the difference by this count plus one. The quotient is the step difference in the blank for successive runs.
- 8.4.2 *Response factor interpolation:* When the difference between the morning and afternoon calibrations is greater than 3% of the mean response factor, it is necessary to interpolate the response factor for calculation of sample concentrations measured during the day. A simple linear interpolation is used. To find the step difference in the calibration factor, find the difference between the two calibrations and divide by the number of intervening runs plus one.
- 8.4.3 *Zero water adjustment:* The CFDW used to make instrument blank measurements throughout the day is often > 0 μMC . When this area is subtracted from the sample peak areas, it results in an over-correction and an under-estimation of the DOC concentration. Thus it is important to adjust the blank correction. This is done by adding the concentration of DOC in the CFDW back to the sample. (For example see sections 8.4.4 and 8.4.5.) The DOC concentration of the CFDW is measured by comparing it to a "primary" DOC free distilled water which has very low DOC and has been set aside for this purpose. It is (by definition) the CFDW that gives the smallest apparent instrument blank.
- 8.4.4 *DOC calculation:* Use the following formula to calculate the DOC concentration of a sample:

$$\text{DOC} = \left| \frac{\text{mean sample area} - \text{blank (CFDW)}}{\text{response factor}} + \text{DOC (CFDW)} \right| \times \text{dil.factor}$$

Where:

mean area sample	=	mean peak area (in mV-secs) for three injections of the sample
blank (CFDW)	=	peak area (in mV-secs) for instrument blank, either the daily mean or the interpolated value
response factor	=	instrument slope as appropriate - either the daily mean or the interpolated value (mV-secs/ μ MC)
DOC (CFDW)	=	apparent DOC concentration of the CFDW used to measure the instrument blank that day
dil. factor	=	dilution factor: Vol (sample)/[Vol (sample) + Vol (acid)]; use only if seawater standards are used to calibrate slope

8.4.5 Sample spreadsheet calculation:

Sample	Area (mV-sec)	Blank (mV-sec)	Net (mV-sec)	RF (mV s/ μ MC)	CFDW (μ MC)	DOC (μ MC)
CFDW	15.3					
SSW-1	187.5	14.7	172.8	2.059	1.2	85.1
SSW-2	186.2	14.1	172.1	2.059	1.2	84.8
SSW-3	183.4	13.5	169.9	2.059	1.2	83.7
SSW-4	191.4	12.9	178.5	2.059	1.2	87.9
CFDW	12.3					

Note: In this example, the instrument blank has decreased over the course of the set of samples but the response factor has stayed constant. The CFDW DOC correction is also constant or it would not be useful as a measure of the instrument blank. No correction for the dilution factor was made because distilled water standards were used to calibrate the instrument.

9.0 Quality control/quality assessment

9.1 *QC charts:* In order to have tight quality control over the analyses, plot the following on a daily basis. Instrument drift or bad blanks will be readily apparent from any trends in the data.

9.1.1 *Daily blanks* (mean with range in μ MC units): Each day plot the mean and the range of all CFDW blanks. A spurious blank will be readily apparent as an anomalously high value; the range should decrease as the combustion tube ages. Note that range = high and low not \pm one standard deviation. Also plot the value of the reference CFDW used to check the bottle of CFDW prepared/used daily.

9.1.2 *Daily response factors:* Each day plot the mean and the range of both calibration tests. Units = area per unit concentration = milli-volt-secs/micro-molar carbon.

9.2 *Quality assurance:* Although the HTC/DI-DOC analytical method has begun to develop some acceptance within the marine chemical community, it is imperative that each investigator demonstrate the validity of their own analyses. This may be accom-

plished via several mechanisms: (1) oxidation of recalcitrant compounds, (2) CRM analyses, (3) comparison with a referee method, and (4) shipboard reference material.

- 9.2.1 *Hard-to-oxidize standards*: The simplest means of determining the “completeness” of oxidation of any particular technique is to analyze a set of seawater samples spiked with a variety of “recalcitrant” organic compounds. Percent yield of CO₂ based on the amount of each standard added is a direct measure of the efficiency of oxidation of the particular method. Suitable test compounds are: alginic acid, caffeine, EDTA, fulvic and humic acids, soluble starch, urea, 2,2'-dipyridyl, and oxalic acid.
- 9.2.2 *Certified Reference Material (CRM) analysis*: Alternatively, if a certified reference seawater were available, then one could check for completeness of oxidation directly. Unfortunately, such a material is not available at this time but may become available in the future.
- 9.2.3 *Referee analysis*: Two mechanisms exist for comparison with a “referee” method. First, is the often tried inter-lab comparison exercises. While these are useful in determining relative accuracy, they often fail to demonstrate whether any of the methods involved achieved truly complete combustion. The second method is to compare the HTC/DI-DOC technique to sealed-tube combustion. Wangersky (1975, 1993) and others have cited this technique as being the most likely candidate for achieving complete oxidation of all the organic carbon in a sample. A direct comparison of samples analyzed by both methods will give an estimate of the “completeness of oxidation” of an individual technique.
- 9.2.4 *Shipboard reference analysis*: In the absence of a CRM-seawater standard, it is possible to simulate one over the course of a cruise. Collect a large volume (>1L) sample at the test station or the first hydro-station from >2000m. The DOC in this sample should be old and relatively stable and recalcitrant. Careful storage at 4°C should preserve it for the course of most normal cruises. Analysis of this sample from time-to-time throughout the cruise will serve as a reliable reference material.

10.0 Notes

10.1 *General precautions*: DOC is the most easy to contaminate substance to be measured in oceanographic samples. As such, stringent anti-contamination protocols must be adhered to at all times. Most important to observe is what others around you may be doing which could adversely affect your samples. A general rule of thumb for DOC contamination is: if you can smell it, then it is probably trouble.

10.1.1 *Sampling*: No amount of post-analysis mathematical manipulation can salvage poorly drawn or contaminated samples. Every precaution should be taken to collect samples in the cleanest environment possible. DOC samples should be drawn first to avoid contamination from the tubing used as transfer lines in the collection of most gas samples. Tygon[®] is especially troublesome. Most troublesome is the rosette interloper. Watch-out for someone who wants to just hop ahead for one sample. Their technique is generally poor and their presence is

especially erratic making any problems they cause intermittent. Above all else, keep your fingers out of the samples. Do not trust rubber/plastic gloves to do anything except keep your hands from getting salty.

10.1.2 *Sample storage*: DOC samples are prone to contamination at this stage as well. Avoid storing samples in refrigerator/freezers which contain copious amounts of organic material, especially fresh (and not-so-fresh) fish. Check-out the reliability of the sample storage bottles carefully and well in advance of when the samples are to be collected. Caps and cap liners are often the cause of inadvertent and highly variable contamination. Do not ever ship sample containers filled with strong acids or bases to clean them while in transport.

10.1.3 *Lab-space requirements*: Just as sample storage space must be odor free, so must the analytical space be free of organic vapors and heavy dust loads. Good ventilation with clean outside air free of organic solvent vapors is a must.

10.2 *Possible modifications*:

10.2.1 *Blank water*: Presently, CFDW serves as an adequate instrument blank checking material. However, in terms of good laboratory practices and a rigorous analytical chemical approach, carbon-free seawater is the unquestionably superior material for measuring the instrument blank. Development of a process to produce this material quickly, reliably, easily and cheaply is a priority.

10.2.2 *Standard solutions*: Several standard compounds (glucose, KHP, etc.) are used as a calibration material as well as both distilled and seawater. Ideally, a single organic compound in a single matrix should be used by the entire community. This protocol recommends KHP in seawater—either deep (>2000m) ocean water or filtered and well-aged coastal seawater. Analytically speaking, one should use the same matrix for blanks and standards as in the samples.

10.3 *Backward compatibility*: It is now apparent that a fair degree of correspondence exists between the historical analyses and the newer HTC/DI-DOC methods. Although there is some evidence that the HTC/DI-DOC technique achieves a higher degree of oxidation efficiency, this increase appears to be small: 10-20%. Three obstacles to a direct comparison of present analyses to the data in the literature exist: Temporal variability, spatial variability and precision of analysis. There is little the analysts can do to avoid the first two; indeed, studying these is one of the objectives of oceanography. However, the third needs considerable attention.

10.3.1 *Precision problems*: Historically, DOC concentrations were regarded as both relatively uniform and invariant, in part, due to the relatively poor precision of the analyses. The uncertainties in these older methods were on the order of 10-25% of the DOC and 10-50% of the gradients. Thus much of the oceanographic information was lost to the imprecision of the methods. By achieving a precision of $\pm 1 \mu\text{MC}$, this situation can be greatly improved and a much more adequate picture of the oceanic organic carbon cycle will be revealed. This level of

precision ($\pm 1-2\%$) can be achieved and should be the goal of each and every analyst.

10.3.2 *Deepwater reference*: One of the more analytically useful features of DOC is that the deep oceanic concentrations of DOC are relatively low, virtually invariant in time and with extremely shallow gradients. The deep water DOC serves as a natural CRM for controlling the quality of the DOC analyses. Thus, each and every cruise where DOC is measured an effort should be made to collect and analyze samples from $>2-3000\text{m}$ as a check against consistency. It will be on the basis of these analyses that we can best compare the results of the newer analytical techniques to the historical database.

10.4 *Volatile organic carbon*: By virtue of the nature of the analytical protocol there is little that a DOC analyst can say regarding the presence or distribution of volatile organic compounds as these were stripped from the samples during the sparging step. For most of the oceanic samples this is of little consequence as these compounds comprise only a tiny fraction of the total DOC pool. However, in certain environments (e.g., sediments, trapped bottom water/fjords, arctic basins, coastal waters and estuaries), this may not be the case and analysts using this technique in these areas should be aware of the potential possibility for analytical artifacts due to the presence or variable distribution of volatiles.

11.0 Intercomparison

11.1 *Other methods*: MacKinnon (1978) and Gershey *et al.* (1979) were among the first to try a direct comparison between methods. Although their sealed-tube measurements were not as easy to perform as the newer HTC/DI-DOC technique, they do provide a similar picture when compared with both the UV and persulfate techniques. The slightly higher yields of the sealed-tube analyses preceded the current HTC/DI-DOC revolution by many years, but the lower precision of the competing analyses did not warrant a significant investment of time nor resources due to the limited statistical reliability regarding this difference.

11.2 *Recent HTC comparisons*:

11.2.1 *Seattle Workshop*: In the late spring of 1991, a community-wide international workshop on the analysis of DOC by various methods —principally by HTC/DI-DOC — was held in Seattle. The results of this workshop are now published (*Mar. Chem.*, **41**(1-3) (1993)). The reader is referred to this report for essential reading regarding the development of the method. While the community failed to achieve an acceptable level of agreement between analyses on common samples, considerable progress to resolving these differences was made and many recommendations for future modifications and improvements are included.

11.2.2 *Bermuda paper*: Sharp *et al.* (1994) have published a comparison of several of the commercially available HTC/DI-DOC analyzers. While the data contained in this report is somewhat limited due to the time and logistical constraints

imposed, there is some useful information in this report regarding modifications (both realized and potential) to these various instruments.

- 11.2.3 *EqPac comparison*: Sharp et al (submitted) have compared several HTC/DI-DOC methods with the modified persulfate technique on a large suite of samples collected during two of the U.S. JGOFS EqPac cruises in 1992. This comparison is unique in the large number of samples involved and the high degree of correlation between several of the analysts. The greater precision of the HTC/DI-DOC analysis versus the modified persulfate technique is also apparent. This paper stands in direct contrast to the Seattle Workshop where values of 30- >300 μMC were reported for a single sample. In this report, typical variations between analysts were on the order of a few μMC .
- 11.2.4 *2nd community-wide comparison*: A second, community-wide, international DOC comparison is in progress (see Sharp *et al.*, 1994). The first stage involved the shipping of blank water, low DOC seawater and spiked seawater to the analysts. The samples were identified to the analysts so they could see how well they were doing relative to a given standard. The second stage will consist of a set of blank water, known standards and several unknown samples. Results will be reported with the analysts identified at a future date.

12.0 References

- Benner, R. and M. Strom. (1993). A critical evaluation of the analytical blank associated with DOC measurements by high-temperature catalytic oxidation. In: *Measurement of Dissolved Organic Carbon and Nitrogen in Natural Waters* (eds. Hedges and Lee). **41**(1-3):153-160.
- Gershey, R.M., M.D. MacKinnon, P.J. Le B. Williams and R.M. Moore (1979). Comparison of three oxidation methods used for the analysis of the dissolved organic carbon in seawater. *Mar. Chem.*, **7**:298-306.
- MacKinnon, M.D. (1978). A dry oxidation method for the analysis of the TOC in seawater. *Mar. Chem.* **7**:17-37.
- Sharp, J. (1973). Total organic carbon in seawater—Comparison of measurements using persulfate oxidation and high temperature combustion. *Mar. Chem.*, **1**:211-229.
- Sharp, J. and E.T. Peltzer (1993). Procedures subgroup report. *Mar. Chem.* **41**:37-49
- Sharp *et al.* (1994). Bermuda instrument comparison. *Jour. Mar. Res.*
- Sharp, J.H., R. Benner, L. Bennett, C.A. Carlson, S.E. Fitzwater, E.T. Peltzer and L. Tupas (submitted). Dissolved organic carbon: Intercalibration of analyses with Equatorial Pacific samples.
- Van Hall, C.E., J. Safranko, and V.A. Stenger (1963). Rapid combustion method for the determination of organic substances in aqueous solution. *Anal. Chem.* **35**:315-319.
- Wangersky, P. J. (1975). Measurement of organic carbon in seawater. pp. 148-162, In: *Analytical Methods In Oceanography*, T.R.P. GIBB (ed.), American Chemical Society, Washington, DC.

Wangersky, P. J. (1993). Dissolved organic carbon methods: A critical review. In: *Measurement of Dissolved Organic Carbon and Nitrogen in Natural Waters* (eds. Hedges and Lee). **41**(1-3):61-74.

Chapter 17. Determination of New Production by ^{15}N

1.0 Scope and Field of Application

This procedure describes the measurement of new production based on the ^{15}N isotope tracer technique first described by Dugdale and Goering (1967). Scientists who employ this or other methods to measure new production should make themselves aware of the current and historical issues that surround these techniques and make appropriate decisions about specific methodologies for their application based on the scientific requirements and constraints of their individual programs.

2.0 Definition

Dugdale and Goering (1967) define new production, described here as nitrate uptake, as "...all primary production associated with newly available nitrogen, for example $\text{NO}_3\text{-N}$ and $\text{N}_2\text{-N}$...". Dinitrogen fixation ($\text{N}_2\text{-N}$) has conventionally been viewed as a minor source of nitrogen uptake in ocean waters¹, therefore, only $\text{NO}_3\text{-N}$ will be considered here. In view of the importance, conceptually and operationally, of differentiating nitrate uptake and uptake of regenerated forms of nitrogen, it is strongly recommended that regenerated production measurements (NH_4^+ uptake, as a minimum) be made in parallel with nitrate uptake measurements.

$$\text{NO}_3\text{-N} = \text{nmol L}^{-1}\text{day}^{-1}$$

3.0 Principle of Analysis

The measurement of nitrate uptake, as defined above, is based on the incorporation of 'trace' additions of ^{15}N -labelled NO_3 into phytoplankton during incubation experiments, similar in principle to the $^{14}\text{CO}_2$ method for measuring photosynthesis.

4.0 Apparatus

Determination of nitrate uptake rates requires knowledge of: (i) the initial substrate (NO_3^-) concentration, (ii) the final concentration of particulate nitrogen and (iii) the final ^{15}N enrichment of the particulate matter.

For determining substrate concentrations $>100 \text{ nmol L}^{-1}$, refer to Chapter 8, "The Determination of Nitrite, Nitrate + Nitrite, Orthophosphate and Reactive Silicate in Sea Water using Continuous Flow Analysis". For concentrations $<100 \text{ nmol L}^{-1}$, Chapter 9, "The

1. Carpenter and Romans (1991) have recently argued that the diazotrophic cyanobacterium *Trichodesmium* may, in fact, be a major contributor to new production via nitrogen fixation in the North Atlantic (and other ocean regions). In view of the known importance of this cyanobacterium in the Arabian Sea and the fact that the next major JGOFS process study will be in the Indian Ocean (Smith et al., 1991), it is recommended that dinitrogen fixation measurements be considered as part of new production estimates.

Determination of Nitrate in Sea Water”¹. For particulate nitrogen, refer to Chapter 15, “Determination of Particulate Organic Carbon and Particulate Nitrogen”².

¹⁵N enrichment is measured by either emission or mass spectrometry. Generally, the emission spectrometer has the capability of analyzing smaller samples but at the expense of precision and accuracy (Fiedler and Proksch, 1975). Newer mass spectrometers, however, can now match the emission spectrometer in the analysis of small masses of N while retaining their superior analytical precision (Owens and Rees, 1989).

5.0 Reagents

¹⁵N-enriched NO₃, as NaNO₃ or KNO₃, is commercially available in dry chemical form at enrichments of 95-99 atom%. Tracer working solutions are made up in distilled/demineralized water. ¹⁵NH₄ is available at similar enrichments as NH₄Cl or (NH₄)₂SO₄.

6.0 Sampling

Sampling protocols will generally follow those outlined in Chapter 19, “Primary Production by ¹⁴C”. Sampling depths should be compatible to the extent possible with depths selected for ¹⁴C experiments³ but additional depths are recommended below the 1% light depth to assess the ‘sub-euphotic zone’ uptake of ¹⁵NO₃⁻ (and ¹⁵NH₄⁺).

7.0 Procedures

- 7.1 Experimentation should be done a minimum of twice daily, once during daylight hours and once during darkness, because N uptake may not be fully light dependant and because bacterioplankton contribute to both NH₄⁺ and NO₃⁻ utilization.
- 7.2 *Tracer additions:* ¹⁵NO₃⁻ and ¹⁵NH₄⁺ should be added at ~10% (or less) of ambient concentration where measurable. For waters where ambient concentrations are below the analytical limit of detection, tracer additions should be at the limit of detection, i.e. ~50 nmol L⁻¹ when conventional nutrient analysis is employed or ~2 nmol L⁻¹ when the new low-level methods are used.
- 7.3 *Incubations:* Incubations of 2-4 hr in light-attenuated deck boxes, cooled by flowing surface seawater, are recommended⁴. Surface seawater temperature may be inappropriate for deeper samples where the subsurface chl_{max} is situated within or below the thermocline. Other arrangements for temperature control during the on-deck measurements of “sub-euphotic zone” uptake will be necessary. Acid-cleaned polycarbonate bottles are to be used (see Chapter 19 for bottle washing technique). Extreme caution should be

1. Both chemiluminescent (Garside, 1982) and autoanalyzer (Raimbault et al., 1990) methods have been described for low-level NO₃ analysis; Brzezinski (1987) describes a solvent-extraction colorimetric method and Jones (1991) a fluorescence method for low-level analysis of NH₄.

2. Most mass spectrometers are now equipped to measure the PN content of the sample as well as isotope ratios. For emission spectrometry, a separate analysis of PN must be done.

3. The selection of attenuation screens used for deck incubations (see below) necessarily define and restrict the depths sampled.

exercised in the use of nitric acid as originally described in the metal-free 'clean' techniques of Fitzwater et al. (1982); copious distilled water rinsing is necessary to insure no residual contamination (NO_3^-). Dilute HCl has been employed as an effective substitute, avoiding the nitrogen contaminant problem (HOTS, 1990; BATS, 1991).

- 7.4 *Filtration/storage*: After incubation, samples are filtered onto Whatman GF/F glass fiber filters under low vacuum pressure (<70mm Hg) and rinsed with filtered seawater to remove residual $^{15}\text{NO}_3^-$ from filter interstices. Care should be taken not to evacuate the filters to dryness (Goldman and Dennett, 1985). Filters are then immediately dried or frozen at -20°C (and later dried) for isotope analysis.
- 7.5 *Isotope analysis*: Under most circumstances, particulates are converted to N_2 gas by the Dumas combustion method. Isotope ratios are determined either by optical emission spectrometry or by mass spectrometry (Fiedler and Proksch, 1975).

8.0 Calculation and Expression of Results

$$\text{Nitrate uptake (nmol L}^{-1} \text{ t}^{-1}) = (^{15}\text{N}_{\text{xs}} \cdot \text{PNt}) / (^{15}\text{N}_{\text{enr}} \cdot \text{t})$$

where:

- t = incubation time in hours
- $^{15}\text{N}_{\text{xs}}$ = excess ^{15}N (measured ^{15}N minus ^{15}N natural abundance, 0.366 atom%) in the post-incubation particulate sample
- PNt = particulate nitrogen content of the sample after incubation¹ in units of nmol L^{-1}
- $^{15}\text{N}_{\text{enr}}$ = ^{15}N enrichment in the dissolved fraction:

$$^{15}\text{N}_{\text{enr}} = [(100 \cdot ^{15}\text{N}) / (^{15}\text{N} + ^{14}\text{N})] - ^{15}\text{N}_{\text{n}}$$

4. Neutral-density screens (e.g. perforated nickel) are usually employed (Lohrenz et al., 1992). Spectrally-corrected 'blue' screens have been recommended for ^{14}C deck incubations (Laws et al., 1989) but the importance for nitrogen measurements has not been well established. Nevertheless, the most realistic conditions possible with regard to light quality, and temperature, are encouraged. *In situ* ^{15}N incubations, parallel with *in situ* ^{14}C incubations and ^{15}N deck incubations, are recommended when possible. Because of the potential problems associated with extended ^{15}N incubations (i.e. non-linearity of uptake after a few hrs, particularly for NH_4), however, additional checks (e.g. parallel time-course measurements from at least one depth and measurements of N concentrations in incubation bottles before deployment and after recovery) are advised to aid in interpreting the results.

1. Some researchers measure PN separately and at the beginning of the experiment. Nitrate uptake will be underestimated to the extent that PN changes (increases) during incubation; short incubations should minimize this except where initial biomass and production rates are extremely high (i.e. rich coastal waters, blooms, upwelling regions). In such cases, delta PN due to microbial N-assimilation can be estimated after the fact (Dugdale and Wilkerson, 1986).

where:

^{15}N = concentration of labelled N, nmol L^{-1}

^{14}N = concentration (same units) of unlabeled N

$^{15}\text{N}_n$ = natural abundance of ^{15}N

Daily (24 hr) nitrate uptake rates ($\text{nmol L}^{-1}\text{d}^{-1}$) are approximated by multiplying the results from the daylight incubations by the number of daylight hrs (the same for the dark incubations and hrs) and adding the two quantities. The procedure of combining the independent “light” and “dark” period uptake measurements is valid only if one is sampling essentially the same water mass at both times. Otherwise, the estimated rates must be normalized (for example, to the chlorophyll level) before combining the rates to come up with a daily rate.

9.0 Quality Control

Sample collection and handling should follow the general precautions outlined for other incubation measurements, e.g. ‘clean’ techniques should be employed to minimize metal contamination, exposure of samples during transport to and from incubators to direct sunlight should be avoided to minimize light shock. Additionally, sources of potential nitrogen contamination (e.g. smoking) should be avoided in sample handling, filtration and isotope analysis.

Emission spectra are generally calibrated using commercial N_2 gas standards of known isotope ratios; mass spectra are generally calibrated using commercial standard reference material (NBS, NIST) as primary standards or locally prepared secondary standards which have been calibrated against the primary standards. Under these circumstances, mass spectrometer accuracy should be absolute. Accuracy of emission spectra, however, is problematic since operational samples are not purified gases as are the commercial standards supplied with the instrument. Periodic calibration against a mass spectrometer, therefore, is required. Precision for mass spectrometers should be ± 0.005 at natural ^{15}N abundance level (0.366 atom%); the value is ± 0.02 for emission spectrometers. Replicate incubations for ^{15}N uptake rates should fall within 5% of the mean (McCarthy *et al.* 1977).

10.0 Intercomparison

Intercomparison is desirable but not essential for ^{15}N ratio analysis since most instrumentation is calibrated against known commercial standard reference materials, e.g. NBS, NIST standards. Sample collection/incubation particulars, however, are likely to differ, making intercomparisons of the actual nitrate uptake measurements (sample collection/incubation/analysis) on the same water mass by the various researchers highly desirable and to be recommended whenever possible.

11.0 Parameters

Attention has recently been drawn to the need for JGOFS researchers to make a clear distinction between “variables” and “parameters” in process studies (Evans, 1991). With regard to nitrate uptake (and nitrogen utilization in general), daily column-integrated N-fluxes as described above are considered ‘variables’. Parameters of relevance to nitrate

uptake fall into three categories: those describing the nitrogen concentration-dependence of uptake, i.e. K_s and V_{max} , similar parameters describing the light-dependence of uptake, i.e. K_i , V_{max} , V_{dark} , and a parameter describing N interactions, specifically the inhibitory effects of NH_4^+ on NO_3^- uptake. Consideration of the appropriate measurement protocols for these 'parameters' is beyond the scope of this report but is judged of some urgency.

12.0 References

- BATS (1991). Bermuda Atlantic Time-Series Study. Field and laboratory methods, 2nd edition, March, 1991, Bermuda Biological Station for Research, Inc.
- Brzezinski, M.A. (1987). Colorimetric determination of nanomolar concentrations of ammonium in seawater using solvent extraction. *Mar. Chem.* **20**: 277-288.
- Carpenter, E.J. and K. Romans (1991). Major role of the cyanobacterium *Trichodesmium* in nutrient cycling in the North Atlantic Ocean. *Science* **254**: 1356-1358.
- Dugdale, R.C. and F.P. Wilkerson (1986). The use of ^{15}N to measure nitrogen uptake in euphotic oceans; experimental considerations. *Limnol. Oceanogr.* **31**:673-689.
- Dugdale, R.C. and J.J. Goering (1967). Uptake of new and regenerated forms of nitrogen in primary productivity. *Limnol. Oceanogr.* **12**: 196-206.
- Evans, G.T. (1991). On parameters and variables. U.S. JGOFS News 2(4): 6.
- Fiedler, R. and G. Proksch (1975). The determination of nitrogen- 15 by emission and mass spectrometry in biochemical analysis: A review. *Anal. Chim. Acta.* **17**: 1-62.
- Fitzwater, S.E., G.A. Knauer and J.H. Martin (1982). Metal contamination and its effects on primary production measurements. *Limnol. Oceanogr.* **27**: 544-551.
- Garside, C. (1982). A chemiluminescent technique for the determination of nanomolar concentrations of nitrate and nitrite, or nitrite alone in seawater. *Mar. Chem.* **11**: 159-167.
- Goldman, J.C. and M.R. Dennett (1985). Susceptibility of some marine phytoplankton species to cell breakage during filtration and post- filtration rinsing. *J. Exp. Mar. Biol. Ecol.* **86**: 47-58.
- HOTS (1990). Hawaii Ocean Time-series Program. Field and laboratory protocols, September, 1990. University of Hawaii.
- Jones, R.D. (1991). An improved fluorescence method for the determination of nanomolar concentrations of ammonium in natural waters. *Limnol. Oceanogr.* **36**: 814-819.
- Laws, E. A., G.R. DiTullio, P.R. Betzer, D.M. Karl and K.L Carder (1989). Autotrophic production and elemental fluxes at 26°N, 155°W in the North Pacific subtropical gyre. *Deep-Sea Res.* **36**: 103-120.
- Lohrenz, S. E., D. A. Wiesenburg, C. R. Rein, R. A. Arnone, C. T. Taylor, G. A. Knauer, and A. H. Knap (1992). A comparison of *in situ* and simulated *in situ* methods for estimating oceanic primary production. *J. Plankt. Res.* **14**: 201-221.
- McCarthy, J.J., W.R. Taylor and J.L. Taft (1977). Nitrogenous nutrition of the plankton in Chesapeake Bay. 1. Nutrient availability and phytoplankton preferences. *Limnol. Oceanogr.* **22**:996-1011.

- Owens, N.J.P., and A.P. Rees (1989). Determination of nitrogen-15 at sub-microgram levels of nitrogen using automated continuous-flow isotope ratio mass spectrometry. *Analyst* **114**: 1655-1657.
- Raimbault, P., G. Slawyk, B. Coste and J. Fry (1990). On the feasibility of using an automated colorimetric procedure for the determination of seawater nitrate in the 0-100 nM range: examples from field and culture work. *Mar. Biol.* **104**: 347-351.
- Smith, S.L., K. Banse, J.K. Cochran, L.A. Codispoti, H.W. Ducklow, M.E. Luther, D.B. Olson, W.T. Peterson, W.L. Prell, N. Surgi, J.C. Swallow and K. Wishner (1991). U.S. JGOFS: Arabian Sea Process Study, U.S. JGOFS Planning Report No. 13, Woods Hole Oceanographic Institution, Woods Hole, Mass., 164 p.

Chapter 18. Determination of Bacterioplankton Abundance

1.0 Scope and field of application

This procedure describes a method for the determination of the abundance of bacteria in seawater using acridine orange or DAPI (4,6-Diamidino-2-phenylindole). The assay is appropriate for measuring oceanic bacterial abundance (10^7 - 10^9 bacteria/kg). Both of the common staining techniques are described below. Some scientists use modifications of these techniques. New techniques of flow cytometry are emerging but are not described here. Scientists who employ this or other methods to measure bacterial abundance should make themselves aware of the current and historical issues that surround these techniques and make appropriate decisions about specific methodologies for their application based on the scientific requirements and constraints of their individual programs.

2.0 Definition

Bacterial abundance is given in terms of the number of bacterial cells/kg seawater.

3.0 Principle of Analysis

Bacteria are preserved, stained with either acridine orange or DAPI and concentrated onto a membrane filter. This causes the individual bacteria cells to fluoresce green (using acridine orange) or bluish white (using DAPI) under blue or ultraviolet excitation respectively on an epifluorescence microscope. The individual cells are counted in fields of view of known area and the concentration of bacteria in the original sample is calculated.

4.0 Apparatus

- 4.1 Any high quality epifluorescence microscope equipped with objectives specifically designed for fluorescence work at $<400\text{nm}$ with immersion oil. The numerical aperture of the objective should be high and the focal plane should be constant across the entire field of vision. Total magnification (objective, eye pieces and auxiliary magnifiers) should be at least 1000x.
- 4.2 A blue filter set (blue excitation 450-490 nm, dichromatic beam splitter 510 nm, barrier filter 520 nm) is used with acridine orange.
- 4.3 An ultraviolet filter set (ultraviolet excitation 365 nm, dichromatic beam splitter 395 nm, barrier filter 420 nm) is used with DAPI.

5.0 Reagents

- 5.1 *Glutaraldehyde*: 25%, Grade II (Sigma)
- 5.2 *Acridine Orange*: 80% dye content (Sigma)

5.3 *DAPI (4,6-Diamidino-2-phenylindole)*: (Sigma)

5.4 *Manostat Aquet Laboratory Detergent*

6.0 Sampling

Samples (95 ml) are measured into a graduated cylinder, then transferred into 125 ml high-density polyethylene bottles. Immediately following collection, the samples are preserved in 5 ml of 0.2 μm prefiltered 25% glutaraldehyde, and stored in the dark at 4° C. The amount of water to be filtered is a function of expected cell number. Following slide preparation, samples should be examined to ensure the proper number of cells (25-100 per field) (Kirchman *et al.*, 1982) and distribution over the field.

Samples should be processed, stained and filtered immediately after sampling to avoid loss of bacterial numbers (Turley and Hughs, 1992).

7.0 Procedures

7.1 *Acridine Orange*: A sample volume necessary to yield approximately 100 cells per field of view (total volume > 2 ml) is combined with 0.05% acridine orange (Sigma, 80% dye content) to a final concentration of 0.005% and filtered at <100 mm Hg onto a 0.2 μm , Irgalan Black stained Nuclepore polycarbonate filter (Hobbie *et al.*, 1977). Uniform cell distribution is obtained by prewetting the ground glass base of the filtration apparatus prior to placement of the wet polycarbonate membrane. After filtration, the Nuclepore filter is immediately mounted while still damp on a slide using Resolve brand immersion oil. The stained bacterial cells can be accurately counted up to one year after preparation if the slides are stored frozen and in the dark.

7.2 *DAPI*: A sample volume necessary to yield 25-100 cells per field of view (Kirchman *et al.*, 1982) is filtered onto a 0.2 μm Nuclepore filter prestained with Irgalan Black. After filtration, the filter is covered with approximately 1 ml of the DAPI solution (50 $\mu\text{g}/\text{ml}$), and left to stain in the dark. Some researchers choose to add 0.3-0.4 ml of a 1 mg/ml DAPI solution to the sample when all but 3-4 ml have filtered. After 5-10 minutes, the DAPI is filtered off and the Nuclepore filter is immediately mounted on a slide using Resolve brand immersion oil 518C ($n_d=1.518$). The stained filters are stored frozen at -20°C in sealed boxes.

7.3 Kirchman *et al.* (1982) recommend a minimum of 7 fields per filter to be counted per sample. Bacteria are distinguished by distinct morphologies which brightly fluoresce; fluorescing images less than 0.2 μm in diameter are disregarded. An eyepiece of known area should be used during enumeration.

8.0 Calculation and expression of results:

$$\text{Bacterial abundance (cells/liter)} = (C_f \times R) / F_s$$

where:

$$\begin{aligned} C_f &= \text{mean number of cells/field} \\ R &= (\text{active area of filter})/(\text{area of field counted})^1 \\ F_s &= \text{volume of water filtered (liters)} \end{aligned}$$

9.0 Quality control

Accurate measurements of sample filtered and preservative added is important for accurate estimates. Calibrated automatic pipets should be used for dispensing sample and preservative.

Accurate, repeatable enumeration of bacterial cells by eye requires experience as well as a good microscope. New enumerators should train by counting the same samples as an experienced microscopist until reliable and consistent results are obtained. Periodic exchange of samples among different microscopists is useful for maintaining data integrity.

Counts may be calibrated by adding fluorescent microspheres to samples prior to counting. These are available in a variety of sizes, 0.4-2.0 μm and fluorescence properties from Duke Scientific Corporation, Box 50005, Palo Alto, CA 94303 USA; tel 800-334-3883.

There is no absolute standard for bacterial counts. Replicate samples drawn from a single Niskin bottle and prepared and counted in parallel should agree to within $\pm 15\%$ over the entire range of abundances encountered if the samples are prepared correctly. The precision of the estimate declines if too few or too many cells are concentrated on the filter. See Kirchman *et al* (1982) for a discussion of subsampling and statistical treatments.

10.0 References

- Hobbie, J.E., R.J. Daley and S. Jasper. (1977). Use of Nuclepore filters for counting bacteria by fluorescence microscopy. *Appl Environ. Microbiol.* **33**: 1225-1228.
- Kirchman, D.L., J. Sigda, R. Kapuscinski, and R. Mitchell. (1982). Statistical analysis of the direct count method for enumerating bacteria. *Appl. Environ. Microbiol.* **44**:376-382.
- Porter, K.G. and Y.S. Feig. (1980). The use of DAPI for identifying and counting aquatic microflora. *Limnol. Oceanogr.* **25**:943-948.
- Turley, C.M and D.J. Hughes. (1992). Effects of storage on direct estimates of bacterial numbers in preserved seawater samples. *Deep-Sea Res.* **39**: 375-394.

1. Note that the active area of filter through which the water passed is not the outer diameter of the filter. It is equivalent to the inner diameter of the bottom of the filter tower used for that filter.

Chapter 19. Primary Production by ^{14}C

1.0 Scope and field of application

This procedure describes a method for the determination of primary production in seawater, expressed as $\text{mg C/m}^3/\text{day}$ or integrated vertically to units of $\text{mg C/m}^2/\text{day}$. The method as described is derived from the methods used in the VERTEX and Bermuda Atlantic Time-series Study (BATS) programs (Fitzwater et al., 1982; Lohrenz et al., 1992) and is suitable for the assay of all levels of primary production found in the ocean. This method description includes some modifications suggested by reviewers either in response to controversy about the methods or to accommodate very different environments (e.g. ice-covered waters). There is still significant controversy about the appropriate techniques for the measurement of primary production and this method is by no means a consensus choice. Scientists who employ this or other methods to measure production should make themselves aware of the current and historical issues that surround these techniques and make appropriate decisions about specific methodologies for their application based on the scientific requirements and constraints of their individual programs.

2.0 Definition

2.1 Primary production is defined as the uptake of inorganic carbon into particulate matter as:

$$\text{Primary production} = \text{mg carbon} / \text{m}^3 / \text{day}$$

2.2 A vertical profile of production measurements can be integrated to yield a production rate per unit area in units of:

$$\text{Primary production} = \text{mg carbon} / \text{m}^2 / \text{day}$$

3.0 Principle of Analysis

The rate of carbon fixation (= primary production) by autotrophs in seawater is measured by tracing the uptake of radioactive ^{14}C from the dissolved inorganic form to the particulate organic form. Radiocarbon is added at a known or assumed ratio to the total inorganic carbon content of the seawater sample. The uptake of radiocarbon by the particulate phytoplankton is converted to total carbon uptake by conversion using this radiocarbon:total carbon ratio. Inorganic carbon uptake into particulate inorganic carbon is not measured as the samples are acidified before analysis. The method is easily expanded to include measurements of size-fractionated particulate production or the net production of radiolabelled dissolved organic carbon.

4.0 Apparatus

4.1 *Scintillation Counter:* The measurement of radioactivity is typically done by liquid scintillation counting. There are a large number of appropriate instruments, each of

which has unique characteristics. As the use of radioisotopes usually involves some level of additional training and expertise in each research institution, it is assumed that the appropriate techniques for the use of the available scintillation counters is available.

- 4.2 *Quench Corrections*: Most scintillation counting techniques require the assessment of the amount of quenching of the scintillation signal by the scintillation cocktails and the particle and dissolved solutions. In some cases, an external gamma source is used to assess quenching of individual filter and liquid samples for conversion of counts per minute (CPMs) to disintegrations per minute (DPMs). Internal standard techniques are also available. Again, the investigator should become familiar with the appropriate quenching corrections for their individual applications.

5.0 Reagents and Supplies

- 5.1 *Stock ^{14}C sodium bicarbonate* (aqueous, specific activity 5 mCi/ml, 5 mCi lots): available from a variety of vendors.
- 5.2 *Teflon bottles* for holding stock ^{14}C solutions (100 mls) and for preparing the stock solutions (500 mls).
- 5.3 *Working Solution*.: A sodium carbonate (anhydrous, Aldrich 20, 442-0) solution is prepared by dissolving 0.15 g in 500 ml Milli-Q water in a 500 ml, acid-cleaned teflon bottle. The 100 ml teflon bottle for holding the ^{14}C stock solution is rinsed with the carbonate solution then 60 mls of the carbonate solution is transferred to the 100 ml teflon bottle. The ^{14}C stock is added to the 60 mls of carbonate solution in the teflon bottle (the actual activity of the stock solution is often variable so the final specific activity is approximately $80 \mu\text{C ml}^{-1}$). The working solution is stored refrigerated (5°C) until use. Some labs recommend further purification of the stock solution to remove any residual trace metal contamination. Many labs make the stock solution in individual small aliquots so that a new aliquot can be used for each daily incubation or cruise. The stock solutions should always be stored in a non-contaminating container (preferably teflon, never glass).
- 5.4 *Acid Cleaning Solution* (0.5 N HCl; Baker Instra—Analyzed): prepared using Milli-Q water. A small aliquot of this solution can also be used for the filter acidification steps.
- 5.5 *Ethanolamine* (Sigma): used to prevent the radiolabelled inorganic CO_2 from escaping to the atmosphere. Other compounds are also acceptable.
- 5.6 *Scintillation Cocktail*: As with scintillation counters, there are a wide variety of scintillation cocktails available on the market. Some of the newer varieties are non-toxic. Each has different efficiencies and quench characteristics. It would be appropriate to compare the chosen cocktail with other labs and with commercially available ^{14}C standards.

- 5.7 *Preparation of Reagents:* Polyethylene gloves should be worn during handling of materials which come into contact with isotope solutions. Gloving precautions fulfill two roles, protecting the wearer from contamination during handling of any materials that have been exposed to isotopes and protecting the living samples from contamination by human skin. Trace metal clean techniques should be used wherever possible.
- 5.8 *Incubation Bottles:* Polycarbonate 0.25 l bottles are used for the productivity incubations. New bottles are soaked for 72 hours in a 5% solution of Micro detergent. Bottles are then rinsed thoroughly with deionized water, and subsequently soaked for 72 hours in the acid cleaning solution. The acid is discarded and the bottles rinsed 3 times with Milli-Q water and then soaked in Milli-Q for at least 48 hours. Once a new bottle has been cleaned as described above, then cleaning between cruises consists of soaking in the acid cleaning solution for several days and rinsing 3 times with Milli-Q. In some applications it may be appropriate to use smaller bottles, however, there is a general feeling (and some published papers) that suggests that larger bottles are preferable. Large bottles have a smaller surface-volume ratio and thus minimize contamination and biological problems associated with the container walls. Larger bottles also result in much larger volumes of radioactive waste. For investigations in any environment, investigators should conduct their own experiments to determine the appropriate container volume. For the measurement of productivity on consecutive days (as on a long transect cruise), it may be advisable to have two or three complete sets of incubation bottles to allow for adequate washing of each set between incubations.
- 5.9 *Pipet Tips.* In the system described here, all pipette samples are 0.25 ml and the entire operation can be accomplished with a single 0.25 ml Eppendorf style pipetter. Before use for inoculating the productivity samples, pipette tips are rinsed 3 times in acid cleaning solution followed by three rinses in Milli-Q water. Cleaned tips are stored in a plastic bag or polyethylene glove until use.
- 5.10 *Trace metal clean water sampling system:* The system for collecting the seawater should be capable of collecting an uncontaminated seawater sample. In the open ocean this is a non-trivial and usually impossible task. GoFlo style bottles are preferred because they are deployed in a closed configuration (they go through the dirty, air-sea interface without contaminating the inside of the bottle). They also lack internal mechanisms (e.g. springs). Traditionally, these bottles are deployed using cloth coated Kevlar hydrowire and plastic coated weights and messengers. Alternative systems can also be employed (e.g. the so-called trace-metal clean rosettes). The cleanliness of samples collected with all of these systems should be documented by a lab qualified to measure trace metals at the appropriate concentrations. It is also good practice to occasionally or routinely collect samples for trace-metal analysis during the cruises to guard against contamination by sloppy handling during the cruise. The GoFlo bottles should be acid cleaned and precautions should be taken to ensure that the bottles do not become contaminated during a cruise.

6.0 Sampling

6.1 Shipboard sampling:

- 6.1.1 *Sampling Depths.* A set of 8 depths bracketing the entire euphotic zone (approximate light levels include 95% – 0.6%) should be selected. The selection process can vary depending on the application. Even spacing of samples between the surface and the 0.2-1.0% light depth is usually appropriate. Some investigators select depths based on the chlorophyll profile. It is important for the subsequent integrations of production data that the deepest depth be below the level of significant production (light bottle approximately equal to dark bottle).
- 6.1.2 *Hydrocast.* Before dawn, seawater samples should be obtained using the Go-Flo bottles deployed on a Kevlar line. The bottom weight on the line is wrapped in plastic. The line is lowered over a plastic-wrapped sheave, and bottles are triggered with plastic coated brass messengers. The hydrocast should be conducted in time to allow sample processing and deployment of the *in situ* array before dawn.
- 6.1.3 *Dispensing Sample.* Polyethylene gloves are worn at all times during handling of samples. Productivity flasks are filled directly from Go-Flos under low light conditions. Bottles are rinsed 3 times before filling. Five bottles are filled for each productivity measurement. In some labs, the entire sample is removed from the GoFlo bottle into an acid-cleaned carboy. This carboy is then transferred to the lab and all subsequent manipulations occur in a clean environment.
- 6.1.4 *Isotope Inoculation.* Under low light conditions, 0.25 ml of the ^{14}C working solution (20 μC) is added to each bottle using an acid cleaned polypropylene pipet tip. One bottle is immediately filtered for a time zero control using the methods described below.
- 6.1.5 *Dark Bottle.* A dark bottle is made by wrapping one of the 5 inoculated bottles in aluminum foil and placing it in a black cloth bag with a velcro closure. If the dark production data are important beyond the minor correction of the light production data, they should also be replicated (triplicate).

6.2 *In Situ* Incubation Procedures

- 6.2.1 The method described here involves an *in situ* incubation of the productivity samples at the depths of collection. *In situ* incubations allow the samples to be exposed to the natural temperatures and light levels (both intensity and spectral quality). Deckboard incubators are also acceptable and in some instances (e.g. production in ice covered areas) are the only acceptable method. Neutral-density screens (e.g. perforated nickel) are usually employed (Lohrenz et al., 1992). Spectrally-corrected 'blue' screens have been recommended for ^{14}C deck incubations (Laws et al., 1989). The most realistic conditions possible with regard to light quality and temperature are encouraged.

- 6.2.2 *Preparations.* The dark bottle and 3 light bottles are hooked together with an appropriate system for suspension on the in situ array. This can be a simple arrangement of plastic electrical cable ties or a complex plastic rack. The incubation bottles should be kept dark until deployment. The suspension apparatus should be tested for recovery under rough conditions.
- 6.2.3 *Deployment.* The productivity array should be deployed before sunrise. The bottom weight, attached to a premeasured polypropylene line, is lowered first. Each group of bottles is then secured to hooks attached to the line at the depth that the sample was originally collected. The entire productivity line is suspended from an orange plastic float, which is attached to a spar equipped with strobe flash and VHF radio beacon. Time and position of deployment are recorded.
- 6.2.4 *Recovery.* Approximately 0.5 hours after sunset, the productivity array is recovered. Sample bottles are detached from the line and placed in dark plastic bags until filtration. Filtrations should be carried out as soon as possible since respiration and grazing continue once the bottles are onboard. Time and position of recovery are recorded.

7.0 Procedures

7.1 Sample analysis

- 7.1.1 *Total Radioactivity.* A 0.25 ml aliquot for counting total added ^{14}C activity is removed from each incubation bottle with a 0.25 ml pipet and placed in a scintillation vial (vial size depends on the scintillation counter, here assumed as 20 ml vial) containing 0.25 ml ethanolamine (Sigma). The mixture is held at room temperature until subsequent liquid scintillation analysis.
- 7.1.2 *Filtration.* Maintaining low light conditions, an aliquot is withdrawn from each productivity bottle using a plastic syringe. In most environments, a 50 ml aliquot is adequate. In some environments, a smaller volume may be appropriate if the filter clogs before 50 mls has been filtered. Some investigators filter the entire sample volume to ensure that large, rare algae are included. The aliquot is filtered onto a 25 mm Whatman GF/F glass fiber filter maintaining vacuum levels of 70 mm Hg or less. The filter is not rinsed (though this is also a debated point). The filter is placed in a 20 ml glass scintillation vial, covered with 0.25 ml 0.5 N HCl (to remove the inorganic carbon), and held at room temperature until subsequent processing.
- 7.1.3 *Filter Processing.* The productivity sample vials are uncapped in a fume hood, and allowed to dry overnight. This procedure insures complete removal of unfixed inorganic ^{14}C . A 10 ml aliquot of liquid scintillation cocktail is added to the dried filters.
- 7.1.4 *Total Radioactivity Sample.* 10 ml of liquid scintillation cocktail plus 2.5 ml Milli-Q water are added to the vials containing the 0.25 ml sample and 0.25 ml ethanolamine (see above). The mixture is shaken vigorously. This method produces a uniform jell with Aquasol and some other cocktails. However, each

cocktail is different in the way it handles large amounts of aqueous solution and an alternative mixture might be required.

8.0 Calculation and expression of results

Rate Calculations. DPM values are converted to daily productivity rates using the following equation:

$$\text{Production (mg C m}^{-3} \text{ d}^{-1}) = ((\text{SDPM}/V) * (W * 0.25 * 10^{-3})/\text{TDPM}) * (1.05/T)$$

where:

SDPM	=	DPMs in filtered sample
V	=	volume of filtered sample (liters)
TDPM	=	Total ¹⁴ C DPMs (in 0.25 ml)
W	=	DIC concentration in samples (approx 25000 mg C m ⁻³ ; should be measured for non-oceanic habitats)
0.25 x 10 ⁻³	=	conversion of pipette volume to liters
1.05	=	correction for the lower uptake of ¹⁴ C compared to ¹² C
T	=	time (days)

8.1 This calculation is made for each light bottle, and the triplicate values are averaged. A similar calculation is made for time zero and dark bottle samples. All values should be reported separately. In some applications, the dark bottle rate is subtracted from the mean rate for the light bottles to correct for non-photoautotrophic carbon fixation or adsorption. At the bottom of a profile, dark bottle values are often equal to light bottle values and some (very small) negative production rates can occur by subtracting dark from light values.

8.2 *Integrated Water Column Production.* The individual depth measurements of daily production are used to calculate water column integrated production (mg C m⁻² d⁻¹) by trapezoidal integration. The rate nearest the surface is assumed to be constant up to 0 m, and a zero rate is assumed for an arbitrarily deep depth (e.g. 200 m). The production at each pair of depths is averaged, then multiplied by the difference between the two depths to get a total production in that depth interval. These depth interval values are then summed over the entire depth range to get the integrated production rate.

9.0 Quality Control

The measurement of primary production generally has no independent method for calibration. Intercomparison of techniques is also difficult without explicit activities on the same ship or same station. Data are generally evaluated for “reasonableness” in the context of other measurements in the area or other measurements by that lab group. The coefficient of variation for replicate variations should be ≤ 10% (Richardson 1991).

10.0 Notes

Safety Precautions and Regulations. The use of radioisotopes is more carefully controlled in most countries than other analytical compounds used in oceanography. Each investigator will have to follow the specific guidelines appropriate for their situation. Issues like waste disposal and the required documentation and training vary widely. It is imperative that people who use isotopes are familiar with the safety issues associated with the use of each isotopes and with general practices for safe handling and disposal of isotopes.

It is important to avoid exposure of productivity samples to high light. This is most important for samples collected from deep in the euphotic zone that are photo-adapted to very low light levels. Short-term exposure to high light can both enhance (provide more light for photosynthesis) or degrade (light shock) the photosynthetic performance of the phytoplankton.

As stressed above, it is extremely important to avoid even trace levels of contamination by metals. Collaborations and interactions between biological and trace-metal chemists help greatly in the development of the appropriate “trace-metal clean awareness” by the biologists.

11.0 References

- Fitzwater, S.E., G.A. Knauer and J.H. Martin (1982) Metal contamination and its effects on primary production measurements. *Limnol. Oceanogr.* **27**: 544-551.
- Joint, I., A. Pomroy, G. Savidge and P. Boyd (1993). Size-fractionated primary productivity in the northeast Atlantic in May-July 1989. *Deep-Sea Res. II* **40**: 423-440.
- Laws, E. A., G.R. DiTullio, P.R. Betzer, D.M. Karl and K.L Carder (1989). Autotrophic production and elemental fluxes at 26°N, 155°W in the North Pacific subtropical gyre. *Deep-Sea Res.* **36**: 103-120.
- Lohrenz, S.E., D.A. Wiesenburg, C.R. Rein, R.A. Arnone, C.T. Taylor, G.A. Knauer and A.H. Knap.(1992). A comparison of in situ and simulated in situ methods for estimating oceanic primary production. *J. Plankton Res.* **14**:201-221.
- Richardson (1991). Comparison of ¹⁴C primary production determinations made by different laboratories. *Mar. Ecol. Prog. Ser.* **72**:189-201.

Chapter 20. Determination of Bacterial Production using Methyl-tritiated Thymidine

1.0 Scope and field of application

This procedure describes a method for estimating bacterial production in seawater from the incorporation rate of methyl-tritiated-thymidine (^3H -thymidine). The technique presented here was first published by Fuhrman and Azam (1980, 1982). Since then, most aspects of the tritiated thymidine incubation technique have been thoroughly investigated. Scientists who employ this or other methods to measure bacterial production should make themselves aware of the current and historical issues that surround these techniques and make appropriate decisions about specific methodologies for their application based on the scientific requirements and constraints of their individual programs.

2.0 Definition

Bacterial production is the rate of synthesis of biomass by heterotrophic bacterioplankton, as estimated by the incorporation of ^3H -methyl thymidine into the cold trichloroacetic acid-insoluble and cold ethanol-insoluble cell fractions following a short term incubation, using a suitable conversion factor, F:

$$\text{Bacterial production (cells kg}^{-1}\text{h}^{-1}) = F * [^3\text{H-thymidine}] \text{ pmole kg}^{-1}\text{h}^{-1}$$

$$F = \text{production of bacterial cells/mole } ^3\text{H-thymidine}$$

3.0 Principle of analysis

The rate of bacterial production is estimated by tracing the specific incorporation of ^3H -thymidine into the TCA-insoluble macromolecular fraction. The incubation is terminated by adding formalin, followed by an extraction of the unincorporated ^3H -thymidine from the bacterial cells in cold TCA and ethanol.

4.0 Apparatus

- 4.1 *Filtration Apparatus.* The tritiated incubation solution can be filtered using any reliable, leak-free, acid-resistant, multi-place filtration unit.
- 4.2 *Liquid Scintillation Analyzer.* Samples in liquid scintillation cocktail are counted on a liquid scintillation analyzer, using the following energy window settings:

Channel A: 0-19 KeV

Channel B: 2-19 KeV

Samples should be counted long enough to reduce the counting error to <5-10%.

- 4.3 *Quench Corrections.* An external gamma source is used to assess quenching of individual filter samples for conversion of counts per minute (CPM) to disintegrations per minute (DPM). Quenching of the total radioactivity vials is determined by an internal standard (usually tritiated water added diluted concentrations of toluene or chloroform as a quencher).

5.0 Reagents

- 5.1 Stock of *methyl-³H-thymidine* (approximately 80 mCi/mmol) is stored in 96% ethanol in the refrigerator. Stock solution should not be frozen.
- 5.2 *Working solution.* An aliquot of the stock solution is transferred to a glass vial where the ethanol is evaporated. The evaporation is promoted by a vacuum pump drawing air through a Silicagel-cartridge and a 0.2 µm Nuclepore filter. The tritiated thymidine is redissolved in 0.2 µm filtered Milli-Q water (1 mCi/5 ml Milli-Q) and stored in the refrigerator not longer than 1-2 days before being used.
- 5.3 *Acid Cleaning Solution* (1N HCl Baker Analyzed) is prepared using Milli-Q water.
- 5.4 *Incubation bottles.* Polycarbonate centrifuge tubes (29 ml) are used for the bacterial productivity incubations. Before every cruise, the tubes are soaked in KOH, rinsed in Milli-Q water and finally soaked in the acid solution overnight. The acid is then discarded and the tubes are rinsed and soaked in Milli-Q water overnight. The polycarbonate tubes are emptied (remaining Milli-Q water is shaken out) and air-dried.
- 5.5 Concentrated (37%) *formaldehyde*
- 5.6 *Trichloroacetic Acid* (TCA) is made up in a 5% solution (weight/volume) in Milli-Q water. A premixed 100% TCA solution can also be purchased and diluted to a 5% working solution. The working solution is kept at 4 °C in the refrigerator. Great care should be taken when working with dry or 100% TCA.
- 5.7 *Ethanol* (96%) is kept at 4 °C in the refrigerator.
- 5.8 *Ethyl acetate* (Purified, Baker Analyzed)
- 5.9 *Liquid scintillation cocktail.* Aquasol (New England Nuclear) or equivalent formulations provide high efficiency counting of low-energy tritium beta particles. Nontoxic, biodegradable scintillation cocktails are now required by some institutions. Ultima Gold (Packard) provides results comparable to Aquasol if cellulose nitrate filters are completely dissolved in ethyl acetate prior to addition of cocktail. Other filter-cocktail combinations should be tested before substitution for those recommended in this manual.

5.10 *Preparation of Reagents and Incubation vessels.* Polyethylene gloves are worn during handling of all materials that are being used for the incubation.

6.0 Sampling and incubation

- 6.1 *Sample dispensing.* Polyethylene gloves are worn during sampling and all subsequent manipulations. The polycarbonate centrifuge tubes are filled directly from the Go-Flos and rinsed 3 times before filling. Three centrifuge tubes are filled from each depth and stored in the dark during sampling. Several killed blanks from different depths should also be prepared. Samples for the estimation of bacterial abundance (see Chapter 18) should be taken at the same time.
- 6.2 *Isotope inoculation.* Under low light conditions, 100 μl of the tritiated thymidine working solution is added to each tube to a final concentration of about 10 nM. Ideally, samples should be inoculated and incubated at *in situ* temperatures. This can be accomplished using temperature-controlled, refrigerated incubators and/or flowing seawater-cooled incubators. The incubation should last sufficiently long to obtain measurable uptake but not so long as to cause uptake to depart from linearity. This may need to be determined for new habitats or depths. 1-2 hours is usually sufficient for most samples less than 200 m.
- 6.3 *Time zero* samples are made from triplicate aliquots of 20 ml of seawater from several depths. The aliquots are terminated by adding 200 μl concentrated (37%) formalin, followed by the addition of 50 μl tritiated thymidine working solution. The solutions are immediately filtered and extracted as described in section 7.1 of this chapter.
- 6.4 *End of Incubation.* The incubation is ended by subsampling aliquots of 20 ml by syringe from each tube into a separate reagent tube containing 200 μl concentrated (37%) formalin. The aliquots are immediately filtered and extracted as described in section 7.1 of this chapter.

7.0 Procedures

- 7.1 *Filtration and extraction.* Under low light conditions, the sample aliquots are filtered onto 25 mm diameter Sartorius (or MFS) cellulose nitrate, 0.22 μm pore size filters, maintaining a vacuum pressure of 70 mm Hg or lower. Mixed esters should not be used as they bind DNA and result in insufficient counting. If care is taken in emptying the reagent tubes, further rinsing is not necessary. After the filter funnel is removed, and with the vacuum pressure maintained, the filters are rinsed with 3 rinses of ice-cold 5% TCA solution from a wash bottle. The TCA rinses are followed with 3 rinses of ice-cold ethanol from another wash bottle. The wash bottles should be kept cold in an ice bucket filled with crushed ice and water during the filtration operation. Care should be taken to rinse the outer edges of the filters.
- 7.2 *Filter processing and counting.* The filters are placed in glass scintillation vials and allowed to dry completely overnight. If 7 ml scintillation vials are used, the filters need

to be folded carefully 3 or 4 times so they are small enough to permit full immersion in the ethyl acetate. 0.5-1 ml ethyl acetate is added to dissolve the filters. Failure to dry or fully cover the filters in the ethyl acetate solution may result in incomplete dissolution and poor counting efficiency. Vortex mixing can be employed to aid in dissolving the filters. Finally, when the filter solution is clear, liquid scintillation cocktail is added, the cocktail solution is mixed and the samples are counted on a liquid scintillation counter.

- 7.3 *Total Radioactivity Sample.* Aliquots of 50 μl from three random incubation tubes are added to a set of three scintillation vials with 10 ml of scintillation cocktail to determine the total amount of label added to the samples.

8.0 Calculation and expression of results

Rate calculations. Universal factors for conversion of ^3H -thymidine incorporation into cell production do not exist (Kirchman *et al.* 1982; Ducklow and Carlson 1992) but there is fair consensus that a the conversion factor (F) varies in the coastal and open ocean within $2 \pm 2 \times 10^{18}$ cells mole $^{-1}$. The rate of incorporation is reported as pmole ^3H -thymidine taken up per time unit after zero-time blank values are subtracted.

$$[\text{methyl-}^3\text{H-thymidine}] \text{ pmole kg}^{-1} \text{ h}^{-1} = (\text{DPM}/2200) \cdot (1000/V) \cdot (1/\text{SA}) \cdot (60/T)$$

Where:

- DPM = disintegrations per minute of sample minus blank value
 V = extraction volume (20 ml)
 SA = specific activity (of added ^3H -thymidine)
 T = incubation time (min)

A check on the final concentration of the tritiated incubation solution is estimated by converting the amount of the measured total activity into the final concentration of tritiated thymidine.

$$[\text{methyl-}^3\text{H-thymidine}] \text{ nM} = (\text{DPM}/2200) \cdot (1000/\mu\text{l}) \cdot (1/\text{SA})$$

Where:

- μl = aliquot taken from incubation solution (50 μl)
 SA = specific activity

9.0 Quality Control

- 9.1 *Standards and precision.* There is no absolute standard for bacterial production measurements and the accuracy is unknown. The coefficient of variation of assays performed carefully following this protocol should be 15-20% for triplicate incubations.

The limit of detection will vary depending on length of incubation and the amount of sample filtered. With care, incorporation rates of $0.05\text{-}0.1\text{ pmol l}^{-1}\text{ h}^{-1}$ should easily be detected above background.

- 9.2 *Non-specific incorporation of thymidine.* Much of the uncertainty with thymidine results appears due to non-specific labelling. Tritiated thymidine does not seclusive enter the bacterial DNA and several studies have demonstrated the labelling of macromolecular compounds other than DNA (Hollibaugh 1988).

Non-specific labelling makes it very important to use an extraction procedure specific for tritiated DNA (Wicks and Robarts 1987, Hollibaugh 1988, Robarts and Wicks 1989). New techniques using enzymatic digestion (Torreton and Bouvy 1991) also look promising.

10.0 Interpretation of results

A conversion factor is needed to derive bacterial production (cells or mass of C or N produced per unit time) from the incorporation rates. Conversion factors should ideally be determined experimentally for each new environment or season sampled. To determine a conversion factor, an independent measurement of bacterial production or growth rate must be made, or the relationship between thymidine incorporation and production must be determined. A variety of approaches exist for this purpose (Bjørnsen and Kuparinen, 1991; Ducklow et al., 1992; Kirchman and Ducklow, 1993). For open ocean sites the conversion factor is generally $2\pm 2\times 10^{18}$ cells produced per mole incorporated.

11.0 References

- Bjørnsen, P.K., and J. Kuparinen (1991). Determination of bacterioplankton biomass, net production and growth efficiency in the Southern Ocean. *Mar. Ecol. Prog. Ser.* **71**:185-194.
- Carman, K.R., F.C. Dobbs and J.B. Guckert. (1988). Consequences of thymidine catabolism for estimates of bacterial production: An example from a coastal marine sediment. *Limnol. Oceanogr.* **33**:1595-1606.
- Ducklow, H.W. and C.A. Carlson. 1992. Oceanic Bacterial Production. *Advances in Microbial Ecology*. K.C. Marshall ed. p. 113-181. Plenum Press.
- Ducklow, H.W., D.L. Kirchman and H.L. Quinby. (1992). Bacterioplankton cell growth and macromolecular synthesis in seawater cultures during the North Atlantic spring phytoplankton bloom, May 1989. *Microb. Ecol.* **24**:125-144.
- Fuhrman, J.A. and F. Azam. (1980). Bacterioplankton secondary production estimates for coastal waters of British Columbia, Antarctica and California. *Appl. Environ. Microbiol.* **39**:1085-1095.
- Fuhrman, J.A. and F. Azam. (1982). Thymidine incorporation as a measure of heterotrophic bacterial production in marine surface waters: evaluation and field results. *Mar. Biol.* **73**:79-89.
- Hollibaugh, J.T. (1988). Limitations of the [^3H]thymidine method for estimating bacterial productivity due to thymidine metabolism. *Mar. Ecol. Prog. Ser.* **43**:19-30.

- Kirchman, D., H. Ducklow and R. Mitchell. (1982). Estimates of bacterial growth from changes in uptake rates and biomass. *Appl. Environ. Microb.* **44**:1296-1307.
- Robarts, R.D. and R.J. Wicks. (1989). Methyl-³H thymidine macromolecular incorporation and lipid labeling: their significance to DNA labeling during measurements of aquatic bacterial growth. *Limnol. Oceanogr.* **34**:213-222.
- Torreton, J.P. and M. Bouvy. (1991). Estimating bacterial DNA synthesis from [³H]thymidine incorporation: Discrepancies among macromolecular extraction procedures. *Limnol. Oceanogr.* **36**:299-306.
- Wicks, R.J. and R.D. Robarts. (1987). The extraction and purification of DNA labelled with methyl-³H thymidine in aquatic bacterial production studies. *J. Plank. Res.* **9**:1159-1166.

Chapter 21. Determination of Bacterial Production using Tritiated Leucine

1.0 Scope and field of application

The leucine (Leu) method for estimating bacterial production consists of measuring the incorporation of radiolabelled leucine into bacterial protein over time. The physiological basis of the leucine method is protein synthesis. Biomass production can be calculated from rates of protein synthesis because protein comprises a large and fairly constant fraction (ca. 60%) of bacterial biomass. By knowing the ratio of protein to total biomass, rates of protein synthesis can be converted to total biomass production. It is possible to calculate biomass production without information about the cell sizes of bacterial assemblages.

Leucine incorporation into protein is measured by following the appearance of radioactivity into material that is insoluble in hot trichloroacetic acid (TCA). This precipitate is mainly protein and radioactive Leu is essentially associated with only protein (Kirchman et al. 1985), although other macromolecules are also insoluble in hot TCA. In addition, Leu is not transformed to other amino acids, which would also be incorporated into protein and would lead to overestimates of the production rate. Finally, leucine comprises a fairly constant fraction of bacterial protein (Kirchman et al. 1985; Simon and Azam 1989), which implies that changes in leucine incorporation are not due to changes in the leucine/protein ratio.

2.0 Definition

Bacterial production is the rate of synthesis of biomass by heterotrophic bacterioplankton, as estimated by the incorporation of ^3H -leucine into the cold trichloroacetic acid-insoluble and ethanol-insoluble cell fraction following a short-term incubation, using a suitable conversion factor, F:

$$\text{Bacterial production (cells kg}^{-1} \text{ h}^{-1}) = F * [^3\text{H-leucine}] \text{ pmole kg}^{-1} \text{ h}^{-1}$$

$$F = \text{production of bacterial cells/mole } ^3\text{H-leucine}$$

3.0 Principle of analysis

The rate of bacterial production is estimated by tracing the specific incorporation of ^3H -leucine into the TCA-insoluble macromolecular fraction. The incubation is terminated, followed by an extraction of the unincorporated ^3H -leucine from the bacterial cells in cold TCA and ethanol.

4.0 Apparatus

4.1 *Filtration apparatus.* The tritiated incubation solution can be filtered using any reliable, leak-free, acid-resistant multiplace filtration unit.

4.2 *Heating block or water bath, 80°C.*

- 4.3 *Liquid scintillation analyzer.* Samples in liquid scintillation cocktail are counted on a liquid scintillation analyzer, using the following energy window settings:

Channel a: 0-19 KeV

Channel B: 2-19 KeV

Samples should be counted long enough to reduce the counting error to < 5-10%.

- 4.4 *Quench corrections.* As in previous chapter.

5.0 Reagents.

- 5.1 Stock of [4,5-³H]-leucine, 40-60 Ci/mmol (New England Nuclear N NET-135H) is stored in the refrigerator and should not be frozen.
- 5.2 *Nonradioactive L-leucine* (Sigma L 8000) for making up working solutions.
- 5.3 *Working solution.*
- 5.4 *Acid cleaning solution* (1N HCl Baker Analyzed) is prepared using Milli-Q water.
- 5.5 *Incubation bottles.* As in previous chapter.
- 5.6 *Trichloroacetic acid (TCA)* 50% wt:vol.
- 5.7 *Ethanol* (80% vol:vol).
- 5.8 *Ethyl acetate* (Purified, Baker Analyzed).
- 5.9 *Scintillation cocktail* (Packard Ultima-Gold).
- 5.10 *0.45 μm X 25 mm filters, cellulose nitrate or mixed esters of cellulose filters* (Millipore HAWP 025 00)

6.0 Sampling and incubation.

- 6.1 Sample water using “clean techniques” (Fuhrman and Bell, 1985). Use plastic gloves to avoid contact with sample. Handling can add amino acids. Acid-rinse sample containers before use. Start incubations as soon as possible (within minutes) after water is sampled.
- 6.2 Place sample into appropriate incubation containers (two to three replicates) and add ³H-Leu (final concentration 10 nM). Set up killed control by adding TCA (5% final

concentration) to a sample. The sample volume will depend on the environment. For eutrophic environments, 5 or 10 ml will be sufficient. For oligotrophic environments or other environments with low rates, 25 ml may be necessary.

- 6.3 Incubate from 10 min to 10 h, depending on sample.
- 6.4 After incubation, add enough 50% TCA to obtain 5% TCA, final concentration. This kills the incubation and starts the extraction.

7.0 Procedures.

- 7.1 Heat sample to 80°C for 15 min.
- 7.2 After it has cooled, filter sample through 0.22 or 0.45 mm cellulose filters (e.g. Sartorius cellulose nitrate to be consistent with the thymidine measurements). The vacuum is not critical but should not exceed 150 mm of Hg.
- 7.3 Rinse filters twice (3 ml) with cold 5% TCA. Rinse twice (2 ml) with cold 80% ethanol (Wicks and Robarts 1988). Remove filter towers and gently rinse (1 ml) with 80% cold ethanol.
- 7.4 When dry, place filters in scintillation vials. Add 0.5 ml of ethyl acetate to dissolve filter. Filter must be completely at the bottom so that this volume of ethyl acetate is effective. After the filter is dissolved, add filters to appropriate scintillation cocktail and radioassay.

8.0 Calculation and expression of results.

- 8.1 Theoretical Approach. This approach is called “theoretical” because it is based on literature values of the various parameters needed to relate Leu incorporation to biomass production. Some of these parameters have been measured for samples from natural aquatic environments (Kirchman et al. 1985; Simon and Azam 1989). The equation for relating Leu incorporation to biomass production $\text{gC l}^{-1} \text{h}^{-1}$ is:

$$\text{Production} = \text{Leu} * 131.2 * (\% \text{ Leu})^{-1} * (\text{C/Protein}) * \text{ID}$$

where Leu is the rate of Leu incorporation (moles per liter per hour). The other parameters are as follows, with the best, current estimates provided by Simon and Azam (1989):

<u>Parameter</u>	<u>Interpretation</u>	<u>Best Estimate</u>
131.2	Formula weight of Leu	
% Leu	Fraction of Leu in protein	0.073
C/Protein	Ratio of cellular carbon to protein	0.86
ID	Isotope Dilution	2

When these best estimates are used, the resulting conversion factor is 3.1 kgC mol^{-1} which is multiplied times the Leu incorporation rate to obtain rates of bacterial biomass production.

- 8.2 *Empirical Approach*: The other approach to relate Leu incorporation to bacterial production is the empirical approach which is described in Kirchman and Ducklow (1993). This procedure is used to estimate a conversion factor (cells or gC per mole of Leu incorporated) that converts Leu incorporation into biomass production. This empirical factor, in theory, includes all possible relationships between Leu incorporation and biomass production, and thus should not be “corrected” further by other factors.

9.0 Other Remarks

- 9.1 The goal of the Leu method is not to obtain turnover rates of amino acids at *in situ* concentrations. The added concentration of Leu is purposely much higher than the *in situ* concentration (usually $< 1 \text{ nM}$). Also, organic contamination (unless extremely severe) will not change short-term rates (Kirchman 1990). Contamination by amino acids and other compounds is potentially a serious problem and obviously should be avoided.
- 9.2 Two processes can contribute to variations in Leu incorporation that are independent of net biomass production and possibly may lead to errors in estimating bacterial production. First, Leu can be synthesized from other compounds, which leads to isotope dilution of the added radiolabelled Leu. The problem is minimized by adding Leu to concentrations high enough (e.g. 10 nM for marine waters and oligotrophic lakes) to “swamp” unlabeled Leu and to repress *de novo* synthesis of intracellular Leu. Isotope dilution experiments can help in selecting the proper concentration (Moriarty and Polard 1981), although this approach apparently does not guarantee that isotope dilution will be zero (Kirchman et al. 1986; Ellenbroek and Cappenberg 1991). Simon and Azam (1989) directly measured intracellular isotope dilution using OPA-HPLC and found that it was about 2-fold when 10 nM Leu was added to coastal waters of southern California. Estimates of intracellular isotope dilution can be very useful, but the methodology is difficult and depends on a reasonable separation of phytoplankton from bacteria (Simon and Azam 1989). Addition of higher Leu concentrations should be avoided because some of the radiolabel may diffuse into or may be taken up by microorganisms other than bacteria, e.g. phytoplankton.

The added concentration of ^3H -Leu should be tested in separate experiments (Moriarty and Pollard 1981). For many environments 10 nM of added Leu has proven to be adequate, although much higher concentrations may be necessary in some eutrophic lakes (R. Bell, pers. comm.). If 10 nM is used, it is not necessary that the entire added Leu be radioactive. Leu incorporation is usually high enough such that rate can be measured with a mixture of 0.5 to 1.0 nM ^3H -Leu plus 9 to 9.5 nM nonradioactive Leu. This mixture is also quite inexpensive. Rates using this mixture should be corrected for the addition of nonradioactive Leu with the following equation: corrected rate = rate with mixture * (nonradioactive + ^3H -Leu)/ ^3H -Leu.

Note only ^3H -Leu, without any nonradioactive Leu, should be used in environments where rates are expected to be low, e.g. deep oceans and highly oligotrophic lakes.

- 9.3 The other potential problem with the Leu method is protein turnover. Microbial cells can synthesize and degrade some proteins, i.e. protein turnover, independent of net growth. Kirchman et al. (1986) found that protein turnover was not important in the only published experiments with natural waters, but protein turnover cannot be ignored, especially when bacterial growth rates are low. If protein turnover is important, Leu incorporation would tend to overestimate biomass production because the radiolabel would be incorporated into new proteins while little radioactivity would be lost as old proteins are degraded. Kirchman et al. (1986) argued that it may be useful to measure protein turnover if organic matter is mineralized during protein turnover. Even so, it complicates interpretation of Leu incorporation.
- 9.4 Formalin can also be used for killed controls as abiotic adsorption of radiolabelled Leu in formalin-killed controls is the same as that with TCA. The problem with formalin is that any surface in contact with it should not be used in incubations with live samples. The fumes from formalin are also noxious and could affect live samples.
- 9.5 Hot TCA extractions of large volumes (> 10 ml) is inconvenient. Alternatively, one can extract the material collected on filters after killing the incubation with a low TCA concentration (0.5%). That is, after filtering the killed sample, the filter is then placed in 5 ml 5% TCA and heated. After extraction and cooling, the 5% TCA is filtered and rinsed. Both filters are radioassayed.
- 9.6 Because nearly all Leu assimilated is incorporated directly into protein (Kirchman et al. 1985), a simpler TCA extraction is often possible (Chin-Leo and Kirchman 1988). Instead of the hot extraction, the sample is killed with TCA and then filtered (cellulose acetate filters) without the 80 °C extraction. The filter is then rinsed as described above.

10.0 References

- Chin-Leo, G. and D.L. Kirchman. 1988. Estimating bacterial production in marine waters from the simultaneous incorporation of thymidine and leucine. *Appl. Environ. Microbiol.* **54**: 1934-1939.

- Ellenbroek, F.M. and T.E. Cappenberg. 1991. DNA synthesis and tritiated thymidine incorporation by heterotrophic freshwater bacteria in continuous culture. *Appl. Environ. Microbiol.* **57**: 1675-1682.
- Fuhrman, J.A. and T.M. Bell. 1985. Biological considerations in the measurement of dissolved free amino acids in seawater and implications for chemical and microbiological studies. *Mar. Ecol. Prog. Ser.* **25**: 13-21.
- Kirchman, D.L. 1990. Limitation of bacterial growth by dissolved organic matter in the subarctic Pacific. *Mar. Ecol. Prog. Ser.* **62**: 47-54.
- Kirchman, D.L., E. K'nees and R.E. Hodson. 1985. Leucine incorporation and its potential as a measure of protein synthesis by bacteria in natural aquatic systems. *Appl. Environ. Microbiol.* **49**: 599-607.
- Kirchman, D.L., S.Y. Newell and R.E. Hodson. 1986. Incorporation versus biosynthesis of leucine: implications for measuring rates of protein synthesis and biomass production by bacteria in marine systems. *Mar. Ecol. Prog. Ser.* **32**: 47-59.
- Moriarty, D.J.W. and P.C. Pollard. 1981. DNA synthesis as a measure of bacterial productivity in seagrass sediments. *Mar. Ecol. Prog. Ser.* **5**: 151-156.
- Simon, M. and F. Azam. 1989. Protein content and protein synthesis rates of planktonic marine bacteria. *Mar. Ecol. Prog. Ser.* **51**: 201-213.
- Wicks, R.J. and R.D. Robarts. 1988. Ethanol extraction requirements for purification of protein labeled with [³H]leucine in aquatic bacterial production studies. *Appl. Environ. Microbiol.* **54**: 3191-3193.

Chapter 22. Microzooplankton Biomass

1.0 Scope and field of application

This procedure describes the methods required for the determination of microzooplankton biomass. JGOFS studies have shown that microzooplankton are numerous in the surface mixed layer of the ocean where they can form a significant stock of organic carbon (Burkill *et al.*, 1993, Harrison *et al.*, 1993, Verity *et al.*, 1993).

2.0 Definition

Microzooplankton are defined *sensu lato*, following Dussart (1963), as phagotrophic organisms that are <200 μm in length. For the sake of operational convenience, the microzooplankton include the pico- and nanozooplankton (0.2-2 and 2-20 μm respectively) of Sieburth *et al.*, (1978) although the latter are treated separately in section 7.

Microzooplankton biomass is defined as the quantity of microzooplankton organic carbon per unit volume of sea-water. The units of this are $\mu\text{gC liter}^{-1}$.

3.0 Principle

Microzooplankton biomass is determined from marine samples collected and freshly fixed at sea. For some procedures, chemical treatment and slide mounting may also be required in the field. Fixed samples are either counted at sea or analysed later in the laboratory by microscopy. Microscopic analysis involves counting and sizing of microzooplankton. Geometrical shapes are assigned to each microzooplankton taxon and organism volumes calculated. These are converted to organism biomass through appropriate volume to organic carbon ratios. Biomass of the microzooplankton community is the sum of biomass of individual organisms divided by the original water volume.

The range of sizes of the microzooplankton (ca 2- 200 μm) requires two different procedures for the quantification of microzooplankton biomass. The larger microzooplankton are quantified using settlement while the smaller cells are concentrated onto filters.

4.0 Apparatus

Research grade inverted/fluorescence microscope(s) and settlement chambers are essential for this research. An image-analysis system and an Apstein net are desirable but not essential. All other apparatus such as computers and spreadsheet software is assumed to be standard to a well-found oceanographic research laboratory.

5.0 Reagents

5.1 *Lugol's iodine*. Acid Lugol's is superior for preserving ciliates but it dissolves calcified material. Separate samples should be preserved with buffered formaldehyde where calcified microzooplankton are important.

5.2 *Strontium sulphate*. Used for preservation of Acantharians.

- 5.3 *Glutaraldehyde*: Use 25% Grade II (Sigma). Glutaraldehyde should be kept frozen until preparation for sample preservation.
- 5.4 *Proflavin*
- 5.5 *DAPI*
- 5.6 *Buffered formaldehyde*: 37% formaldehyde solution saturated with sodium tetraborate or hexamine.
- 5.7 Note that fixatives and preservatives are poisonous and some are probably carcinogenic. Adequate care should be taken at all times.

6.0 Sampling

Vertical profile samples should be taken through the surface mixed layer by CTD/rosette or Niskin bottle. Onboard ship, samples must be treated carefully as many protozoa are delicate. The optimal approach is for samples to be siphoned into containers to which fixative/preservatives have been added. Samples should be fixed as quickly as possible. Drainage through small diameter valves in the bottom of the Niskin bottles may damage some organisms.

7.0 Procedures

Two complementary techniques are required for the quantification of microzooplankton biomass. The larger (ca 20 - 200 μm) organisms such as many ciliates and dinoflagellates are quantified by settlement microscopy (as given in 7.1 below). The smaller (ca 2-20 μm) organisms such as flagellates are enumerated by epifluorescence microscopic analysis of stained samples held on microscope slides (as given in 7.2 below). These should be processed immediately or stored frozen until analysis. Frozen slides should be stored once only and analyzed, not thawed and refrozen.

Fluorescence microscopes should have filter sets for i) UV excitation and blue emission, and ii) blue excitation and green and red emission. Analysis should be carried out with either x63 or x100 objectives. Random fields or transects of filters should be examined, and cells counted and sized either visually or by image analysis (Verity & Sieracki, 1993). Exposure of cells to excitation light should be minimized.

- 7.1 *Quantification of microzooplankton (ca 20-200 μm in size) abundance and biomass by settlement microscopy*. Take between 250 ml and 2L seawater depending on microzooplankton concentrations, from a Niskin bottle, fix in 1-10% acid Lugol's iodine. Add strontium sulphate solution to make 2 mg/l final concentration. Store samples in the dark. Take sub-sample of 50 to 100 ml and concentrate by sedimentation for 24 hours. Identify, count and measure all microzooplankton using an inverted microscope. Cells can be sized either by calibrated ocular micrometer or by image analysis. This allows an estimate of cell volume to be made for the subsequent calculation of carbon content.

7.2 *Determination of pico- and nano-flagellates (ca 2 - 20 μm in size) by epifluorescence microscopy.* Take 50 ml (or more if concentrations are low) from a Niskin bottle, fix in 0.3% final concentration fresh glutaraldehyde (previously stored chilled or frozen), stain with 5 $\mu\text{g}/\text{ml}$ DAPI for five minutes. Counterstain with proflavin which allows the cell outline to be determined, also at a final concentration of 5 $\mu\text{g}/\text{ml}$. Concentrate sample on a 0.8 μm black polycarbonate filter, using a backing filter to enhance even distribution of cells. Mount filter onto a glass slide with a small drop of immersion oil between the filter and cover-slip. Process slide immediately or freeze until subsequent analysis.

Recent work (Stoecker et al., 1987) has shown that many protozoan microzooplankton can be plastidic and may therefore be photosynthetic. This functional diversity may be important and if so, the following procedure should be used to differentiate plastidic from non-plastidic cells and autotrophic and mixotrophic from heterotrophic dinoflagellates.

7.3 *Differentiation of plastidic and non-plastidic cells.* Fix 250ml sea-water in 2% hexamine buffered formaldehyde as above. Store samples at 4°C in the dark until they can be enumerated by autofluorescence microscopy. Note that this technique is good for ciliates and dinoflagellates.

7.4 Sampling microzooplankton using water bottles will produce a statistically inadequate record of rare organisms. If quantitative information on rare microzooplankton is required the following procedure should be used.

7.5 *Enumeration of rarer microzooplankton.* Gently filter 20 liters from water bottle through a fine mesh (e.g. 20-30 μm) to a final volume of 200 ml. Fix for subsequent settlement microscopy for sarcodines, tintinnids and metazoa. Alternatively for a qualitative assessment of rarer microzooplankton species, tow an Apstein net fitted with a 20 μm mesh vertically through the surface mixed layer. Samples collected can be observed live and fixed, for later identification.

8.0 Calculation and expression of results

An example of the complete computation for procedures 7.1.1 and 7.1.2 above is shown below:

Organism No.	Taxonomic ID	Area (μm^2)	Length (μm)	Geometrical shape	Cell vol. (μm^3)	Cell carbon (pg C)	Biomass ($\mu\text{g C l}^{-1}$)
1	Ciliate sp. A	94	13	ellipsoid	567	108	0.00216

8.1 Assign number to each microzooplankton organism to be counted, starting from 1 and work sequentially upwards.

- 8.2 Identify microzooplankton organism to appropriate level of taxonomic resolution.
- 8.3 Determine dimensions including length of organism (μm) from microscopic measurements and /or image analysis.
- 8.4 Calculate volume of organism using appropriate geometric formula. Ciliate sp a is an ellipsoid volume for which the appropriate volume (in μm^3) is $(8/3\pi) * \text{area}^2/\text{length}$ (image analysis) or $(1/6) \pi \text{length} * \text{breadth} * \text{depth}$ (measurement by eye).
- 8.5 Calculate organism carbon content (pgC) using appropriate volume to carbon conversion factor. In this case, for ciliates, this is $0.19 \text{ pg C } \mu\text{m}^{-3}$ (Putt & Stoecker, 1989) and for dinoflagellates $0.14 \text{ pg C } \mu\text{m}^{-3}$ (Lessard, 1991). Note that conversion factors can vary depending on type of fixative and concentration.
- 8.6 Calculate organism biomass concentration (pg C ml^{-1}) by dividing carbon content by volume of sample settled (mls). In this case, 50 mls were settled.
- 8.7 Convert concentration to $\mu\text{gC l}^{-1}$, multiply by 10^3 .
- 8.8 Sum biomass for each taxonomic group (e.g. Ciliate sp A) to obtain total biomass of that taxon and then sum all taxa to get microzooplankton biomass in sample.
- 8.9 Calculations on the standing stock per unit sea surface may be made by integrating microzooplankton biomass with depth.

9.0 Quality control and assessment

There is no standard for this measurement and the accuracy is unknown.

As many cells as is practically possible should be counted; this is likely to be 50-200 cells of each of the common taxonomic groups. If possible subsamples should be taken for a few of the water-bottles to check sample replication.

10.0 Notes

- 10.1 The iodine present in Lugol's samples is volatile and photosensitive. The concentrations may therefore decrease with time. Samples should ideally be stored in colored glass bottles in the dark and inspected yearly. Readdition of Lugol's solution may be required. The initial concentration of Lugol's used has been found to vary from 1 to 10% depending on the scientist. There is no evidence to date, as to which concentration is preferable, although some scientists believe that cell loss occurs at 1%.
- 10.2 A general discussion of biomass conversion factors among various planktonic trophic and size groups is given in Verity *et al.*, (1992).

- 10.3 It should be remembered that many microzooplankton organisms are fragile; water samples should be treated with care prior to fixation and are best fixed as soon as possible after collection.

11.0 Intercomparison

No intercomparisons have been carried out in JGOFS, although this is a recommendation for the future.

12.0 References & JGOFS papers published using these techniques

- Burkill, P.H., Edwards, E.S., John, A.W.G. & Sleight, M.A. 1993. Microzooplankton and their herbivorous activity in the north-east Atlantic Ocean. *Deep-Sea Research II* **40**: 479-494.
- Dussart, B.M. 1963. Les differentes categories de plancton. *Hydrobiologia* **26**: 72-74.
- Harrison, W.G., Head, E.J.H., Horne, E.P.W., Irwin B., Li, W.K.W, Longhurst, A.R., Paranjape, M.A. & Platt, T. 1993. The Western North Atlantic Bloom Experiment. *Deep-Sea Research II* **40**:279-305.
- Lessard, E.J. 1991. The trophic role of heterotrophic dinoflagellates in diverse marine environments. *Marine Microbial Food-Webs* **5**: 49-58.
- Putt, M. & Stoecker, D.K. 1989. An experimentally determined carbon:volume ratio for marine oligotrichous ciliates from estuarine and coastal waters. *Limnology & Oceanography* **34**: 1097-1103.
- Sieburth, J.McN., Smetacek, V. and Lenz, J. 1978. Pelagic ecosystem structure: Heterotrophic compartments of the plankton and their relationships to planktonic size fractions. *Limnology and Oceanography* **23**: 1256-1263.
- Sieracki, M.E., Verity, P.G. and Stoecker, D.K. 1993. Planktonic community response to sequential silicate and nitrate depletion during the 1989 North Atlantic spring bloom. *Deep-Sea Research II* **40**: 213-226.
- Stoecker, D.K., Michaels, A.E. & Davies, L.H. 1987. Large proportion of marine planktonic ciliates found to contain functional chloroplasts. *Nature* **326**: 79-792.
- Verity, P.G., and Sieracki, M.E. 1993. Use of color-image analysis and epifluorescence microscopy to measure planktonic biomass. In: Handbook of Methods in Aquatic Microbial Ecology (Kemp, P.F., Sherr, B.F. & Cole, J.J. Eds) Lewis, Boca Raton.
- Verity, P.G., Robertson, C.Y., Tronzo, C.R., Andrews, M.G., Nelson, J.R. and Sieracki. 1992. Relationships between cell volume and the carbon and nitrogen content of marine photosynthetic nanoplankton. *Limnology and Oceanography* **37**: 1434-1446.
- Verity, P.G., Stoecker, D.S., Sieracki, M.E., Burkill, P.H., Edwards E.S. & Tronzo, C.R. 1993a. Abundance, biomass and distribution of heterotrophic dinoflagellates during the North Atlantic Spring Bloom. *Deep-Sea Research II* **40**: 227-244. 1993
- Verity, P.G., Stoecker, D.K., Sieracki, M.E. and Nelson, J.R. 1993b. Grazing, growth and mortality of microzooplankton during the 1989 North Atlantic spring bloom at 47°N, 18°W. *Deep-Sea Research II* **40**: 1793-1814.

Chapter 23. Microzooplankton Herbivory

1.0 Scope and field of application

This procedure describes the experimental methods required for the quantification of microzooplankton herbivory in natural communities. Microzooplankton herbivory has been shown in JGOFS and other studies to be a major pathway for the trophic transformation of phytoplankton in surface waters (Burkill *et al.*, 1993, Verity *et al.*, 1993). It therefore provides important information about the flux of organic carbon in surface waters.

2.0 Definition

- 2.1 Microzooplankton are defined, following Dussart (1963), as phagotrophic organisms that are $< 200 \mu\text{m}$ in length. For simplicity's sake, this encompasses the nanozooplankton (2-20 μm) of Sieburth *et al.* (1978).
- 2.2 Microzooplankton herbivory is defined as the rate of grazing of phytoplankton organic carbon by microzooplankton per unit volume of seawater. The units of this are $\mu\text{g C liter}^{-1} \text{ day}^{-1}$.

3.0 Principle

Although several approaches for quantifying microzooplankton herbivory are possible and these have been summarized in the earlier JGOFS Report on Core Measurement Protocols (SCOR, 1989), one of these has been used routinely in JGOFS. This is the "dilution approach" of Landry & Hassett (1982). The dilution approach protocol is based on the experimental determination of phytoplankton growth in a dilution series. The dilution series is made up by combining the natural microbial community with seawater that has been filtered free of microbial components. The theoretical and practical considerations of this technique are fully described in Landry and Hassett (1982) and updated in Landry (1993). Essentially, phytoplankton growth is assumed to be density independent with specific growth rates that are constant for all dilution conditions. In situations where this is an issue, controls should be run with amended nutrient concentrations. Per capita clearance rates of microzooplankton are assumed to be constant among the dilution treatments, leading to proportionately higher phytoplankton mortality with greater concentrations of microzooplankton. Consequently there is a progressive uncoupling with dilution between phytoplankton growth and mortality due to grazing. It is further assumed that phytoplankton growth and grazing mortality are appropriately represented by exponential rates.

The protocol is therefore based on quantifying the specific growth rates of phytoplankton in dilutions of different known concentrations. Phytoplankton growth rates are determined from time course incubations.

Microzooplankton biomass measurements (see Chapter 22) of the experimental water should be made in support of the experimental work.

4.0 Apparatus

- 4.1 Polycarbonate (or Teflon) experimental ware including incubation bottles. The latter should be 2 to 5 liter capacity scaled to the concentration of phytoplankton in the experimental water and the method used for its determination.
- 4.2 Free floating rigs for *in-situ* incubation or an incubator for simulated *in-situ* incubations.
- 4.3 Nitex 200 μm gauze and large volume filtration system for the production of seawater free from pigment-containing particles.
- 4.4 High sensitivity fluorometer, spectrophotometer or HPLC system plus ancillary equipment for quantification of phytoplankton chlorophyll (see chapters 13 and 14). Access to suitable room to minimize temperature changes to experimental water while setting up dilutions.

5.0 Reagents

Acetone (90%) and HCl (10%) for extraction and quantification of chlorophyll *a* and other pigments, if required.

6.0 Sampling

- 6.1 Experimental samples should be taken using clean acid-rinsed Go-Flo or Niskin water bottles from the depths of interest by CTD/rosette or conventional profiling. Experimental water should be obtained from a minimum of two depths; one of these should target depth of highest grazing—the depth of highest phytoplankton production is a good marker. Other sampling depths should be associated with any relevant oceanographic markers (e.g. subsurface chlorophyll maximum, pycnocline, etc.).
- 6.2 On board ship, samples must be treated carefully as many protozoa are delicate. Samples to be siphoned from the water bottle directly into polycarbonate bottles prior to addition of particle-free dilution water.
- 6.3 Sampling for microzooplankton herbivory experiments should coincide with obtaining samples for primary production and, if possible, macrozooplankton herbivory and bacterial production. To coincide with primary production, water sampling would typically occur prior to local dawn.

7.0 Procedures

- 7.1 Before starting experiments, ensure experimental bottles are marked up for appropriate dilution (e.g. 40% concentration should be marked externally with water proof marker to hold 40% of its full volume) and that all experimental polycarbonate ware has been acid cleaned and then distilled water rinsed. Typical concentrations used in a dilution series should be 100%, 70%, 40% and 10% of ambient concentration with triplicate

bottles incubated at each concentration. A larger number of dilutions would be preferable for greater precision.

- 7.2 Water must be collected with appropriate clean water bottle techniques, as described above. Filter as much water as required (approximately half the overall water) free of phytoplankton using 0.2 μm porosity Gelman Suporcap filter capsules. If these capsules are unavailable, use Triton-free acid washed methyl cellulose filters. Filters must have been acid (10% HCl) washed and rinsed with Milli-Q water before use. Discard the first few liters of filtered seawater and retain the remainder. Add filtered seawater to bottles as appropriate.
- 7.3 Carefully, but rapidly, siphon experimental water through 200 μm gauze into experimental bottles and fill to the top.
- 7.4 Store experimental bottles temporarily in dim light at close to ambient *in situ* temperature. Mix bottles gently by inverting them slowly. Take subsamples from each bottle or sacrifice duplicate bottle for phytoplankton pigments and filter onto 0.2 μm Nuclepore filter. Store filter deep frozen until required for analysis. Sub-samples should also be taken from each bottle for determination of microzooplankton at beginning and end of experiment which should last 24 hours.
- 7.5 Under extreme conditions of oligotrophy, when phytoplankton growth may be nutrient limited, supplementary nutrients should be added to minimize this effect. This is discussed by Landry (1993).
- 7.6 Experimental dilution bottles should be incubated *in situ* on a free-floating rig in parallel with the conventional primary production measurements. This ensures direct inter-comparisons are valid. If this is impossible, incubation under simulated *in situ* conditions onboard ship may be carried out either using an illuminated incubator or deck incubation equipped with appropriate light attenuation filters.
- 7.7 Phytoplankton should be quantified through measurement of chlorophyll or other photopigments as soon after sampling as possible, since pigments degrade rapidly. Photopigments may be analysed fluorometrically (Yentsch & Menzel, 1963), by spectrophotometry (Jeffrey & Humphrey, 1975) or by HPLC (Mantoura & Llewellyn, 1983) with appropriate modifications recommended in the JGOFS Protocol. HPLC analysis is the preferable approach since it allows the quantification of taxon-specific photopigments. The coupling of HPLC analysis of photopigments to the dilution technique allows considerably greater interpretation of microbial dynamics (Burkill et al., 1986; Verity et al., 1993). However, HPLC is much more specialized and resource-demanding than conventional fluorometry.
- 7.8 An alternative and perfectly acceptable approach for the quantification of phytoplankton is via conventional microscopical analysis of phytoplankton cells in the experimental bottles. This approach will yield information on the dynamics of individual phytoplankton taxa.

8.0 Calculation and expression of results.

An example of the complete computation is shown below:

8.1 Dilution experiment No 1 results:

- 8.1.1 Calculate turn-over rate of phytoplankton by microzooplankton (days^{-1}) from slope of regression equation ($= 1 - e^{-\text{slope}}$).
- 8.1.2 Calculate rate of grazing of chlorophyll ($\mu\text{g chl liter}^{-1} \text{ day}^{-1}$) from turnover rate by multiplying by ambient chlorophyll concentration ($= \text{chlorophyll concentration} * \text{turnover rate}$).
- 8.1.3 Calculate rate of grazing of phytoplankton carbon by microzooplankton from chlorophyll rate * carbon to chlorophyll ratio. This ratio varies between 10 and 200. An average for the N Atlantic in 1989 was 32. It should be determined independently.
- 8.1.4 For further details on these see Landry and Hassett (1982) and Burkill et al. (1986).

9.0 Quality control and assessment

There is no standard for this assay and the accuracy cannot be determined.

A minimum of two experiments should be performed during the occupancy of each station. Several estimates made on one station a few days apart will allow interpretation of the temporal pattern of grazing.

10.0 Notes

It should be remembered that many microzooplankton organisms are fragile; water samples should be treated with care prior to fixation. Experiments should be carried out as soon as possible after collection.

11.0 Intercomparison

No intercomparisons have been carried out in JGOFS, although this is clearly desirable for the future.

12.0 References & JGOFS papers published using these techniques

- Burkill, P.H., Edwards, E.S., John, A.W.G, & Sleigh, M.A. 1993. Microzooplankton and their herbivorous activity in the north-east Atlantic Ocean. *Deep-Sea Res. II*. **40**: 479-494.
1993
- Burkill, P.H. Mantoura, R.F.C., Llewellyn, C.A. and Owens, N.J.P. 1986. Microzooplankton grazing and selectivity of phytoplankton in coastal waters. *Mar. Biol.* **93**: 581-590.
- Dussart, B.M. 1963. Les differentes categories de plancton. *Hydrobiol.* **26**: 72-74.

- Jeffrey, S.W. and Humphrey, G.C. 1975. New spectrophotometric equations for the determination of chlorophylls-a, b, c1 and c2 in higher plants, algae and natural phytoplankton. *Biochem. Physiol. Plantz.* **167**: 191-194.
- Landry, M.R. 1993. Estimating rates of growth and grazing mortality of phytoplankton by the dilution method. In: Handbook of Methods in Aquatic Microbial Ecology (Kemp, P.F., Sherr, B.F. & Cole, J.J. Eds) pp 715-722 Lewis, Boca Raton.
- Landry, M.R. and Hassett, R.P. 1982. Estimating the grazing impact of marine microzooplankton. *Mar. Biol.* **67**: 283-288.
- Scor 1990. Grazing by microzooplankton. In: SCOR/JGOFS Report No 6: Core Measurement Protocols. Reports of the Core Measurement Working Groups. pp 31-37.
- Sieburth, J.McN., Smetacek, V. and Lenz, J. 1978. Pelagic ecosystem structure: Heterotrophic compartments of the plankton and their relationships to planktonic size fractions. *Limnol. Oceanogr.* **23**: 1256-1263.
- Verity, P.G., Stoecker, D.K., Sieracki, M.E. & Nelson, J.R. 1993. Grazing, growth and mortality of microzooplankton during the 1989 North Atlantic spring bloom at 47°N, 18°W. *Deep-Sea Res.* **40**: 1793-1814.

Chapter 24. JGOFS Sediment Trap Methods

1.0 Introduction

An ideal sediment trapping protocol would strictly define details of trap design, deployment, sample collection methods, sample processing, analytical methods and calculations. However, the general consensus is that the present state-of-the-art of sediment trapping is not yet sufficiently developed to justify such a rigorous protocol. The major difficulty is the paucity of data to enable one to quantitatively compare the relative merits of different designs and techniques. Further, given the present state-of-the-art, it is difficult to envisage a unique protocol being valid for the wide range of oceanic deployment environments and sample types.

Although the principal merit of a rigorous protocol, namely the comparability of data determined by different groups and in different environments, is a highly worthy one, the problems outlined above dictate that such rigour would be presently inappropriate. The protocols presented here aim to (i) constrain procedures to an extent that sediment trap data comparability between different deployments and laboratories is improved, and (ii) provide realistic estimates of downward particulate fluxes. The broad consensus protocol is given, supported by comments summarizing other recommendations, guidelines and considerations (many aspects of which are described in more detail by US GOFs Working Group, 1989). It is intended that the flexibility within these protocols be further reduced, according to the consensus opinion of participating groups, during coordinated studies where comparability of data sets is paramount e.g. region-specific process studies, studies of mesoscale variability.

2.0 Scope and Field of Application

The sediment trap technique may be used for the collection of downward-settling particulate matter in the ocean water column. Analysis of the material thus collected enables (a) the estimation of the downward particulate fluxes of a wide variety of chemical and biological components and (b) the elucidation of the qualitative nature of these components. Traps can be deployed throughout the water column moored either to the seabed or to drifting surface buoys, and samples collected over time periods, and through time-series, of up to the order of one year. Temporal and spatial information is thus accessible.

3.0 Definition

The downward particulate flux of a component is defined as the quantity of that component settling through a given horizontal area in a given time. This flux is expressed in dimensions of quantity per horizontal area per time. A sediment trap provides an estimate of this flux by collecting, during a measured time period, material settling to the bottom of the trap having entered through a trap opening of known area. A number of physical, biological, chemical and hydrodynamic factors, reflecting both natural oceanographic processes and artifacts induced by the trap/mooring and sample treatment/analysis, can affect the accuracy of this estimate (summarized here, and in detail by US GOFs Working Group, 1989). Flux estimates are therefore dependent to some extent on choices of trap/mooring design and hardware, deployment methods, sample treatments, analytical procedures and data interpretation.

4.0 Principle of Analysis

Sediment traps can be used to collect settling particles. There is considerable evidence that much of the mass of particulate material transported from surface waters to the deep ocean and ocean floor is in the form of large, fast-settling particles. The mass of material collected should thus be dominated by this particle component. Information derived from the analysis of such samples can be used to help identify and quantify the chemical, physical and biological processes affecting and influenced by downward fluxes.

5.0 Apparatus

Protocol sediment trap designs are to take into account the hydrodynamic effects of trap geometry (aspect ratio) and the configuration of the baffles at the trap opening. Guidelines are not rigid (US GOFS Working Group, 1989). All moorings should be designed to maintain vertical trap orientation and are to be instrumented with pressure and flow sensors at trap depths. Drifting arrays should further be designed (i) to minimize current flow relative to each trap (so as to reduce hydrodynamic interference), (ii) so that the surface buoy is not wind-driven, and (iii) to achieve effective decoupling of the traps from surface waves.

Comments: In addition to flow and current sensors, tilt meters on each trap are recommended. Mesh screens below trap baffles, proposed for the exclusion of large “swimmers” (section 8.2), are not recommended for routine deployments without further justification (US GOFS Working Group 1989).

6.0 Reagents

No specific recommendations other than described in sections 7.4.1 and 8.6. Reagents used in trap solutions and sample treatments should be of a quality that does not contaminate with intended analytes or components that interfere with their analysis.

7.0 Sampling

7.1 *Deployment Environment:* Avoid high current environments for fixed moorings and high current shears for drifting arrays; present state-of-the-art mooring and trap technology is inappropriate for such conditions. Minimize flow relative to drifting traps by careful mooring design (especially when shears are high). Acceptable flow limits cannot be generally defined for all trap designs, but relative flows of several tens of cm/second are not acceptable (Baker et al. 1988). Groups simultaneously deploying drifting arrays as part of site-specific studies should use the same trap depths selected according to oceanographic features. Fixed mooring trap depths in the upper water column should be limited by the flow environment. International reference depths to be at 1000 m below surface (if possible) and deeper 1000 m interval horizons.

7.2 *Temporal Resolution:* The finest temporal resolution that allows a continuous time-series throughout the study period and provides sufficient material in each sample for the intended analyses is the ideal. Likely diurnal and seasonal variability should be considered when deciding resolution for drifting and fixed traps respectively.

7.3 *Trap Solutions:* Sample cup solutions are designed to preserve collected material (including swimmers) and to reduce diffusive, advective and resuspension losses of sample cup contents. This is attempted by using seawater dosed with preservative and NaCl (to provide a density discontinuity relative to the ambient seawater). The solution is prepared by dosing seawater (from deployment depth or filtered surface water) to a final concentration of 2% buffered formaldehyde (5% buffered formalin) and a 5psu excess salinity. Formalin is buffered by saturation with borate. An aliquot of cup solution is retained for blank corrections.

7.4 *Comments*

7.4.1 A preservative is essential for long-term deployments. Its use is less attractive for short-term (few day) deployments where organic carbon degradation may induce less error than artifacts from preservative use. However, short-term deployments are usually in shallow waters where swimmer contamination (section 8.2) is often a major problem. In such a case the use of a preservative/poison is contentious; large amounts of dead/fragmented swimmers may pose a greater problem than allowing swimmer activity and organic matter degradation.

7.4.2 Formaldehyde appears to be the most effective and suitable general purpose preservative of those tested (e.g. Knauer et al. 1984), and is recommended until more viable alternatives are proven. The major drawback of formaldehyde is that it precludes the accurate measurement of dissolved natural C levels, and thus prevents the determination of particulate C leached into solution. Although it has previously been held that the non-carbon based alternatives, poisons such as Hg salts and azides, are not such effective inhibitors of the degradation of organic matter, recent evidence (Lee et al. 1992) suggests that mercuric chloride and sodium azide can be as effective as formaldehyde in this respect. These poisons have the advantage of allowing dissolved natural C determinations, but are less effective than formaldehyde at preventing swimmer fragmentation and may cause difficulties with trace metal contamination.

7.4.3 The salinity enhancement is recommended, despite certain potential drawbacks such as particles not settling through the density discontinuity and chemical effects inducing enhanced leaching. The relative importance of such drawbacks compared to the benefits (see above) of a salinity enhancement has not been demonstrated for field deployments. Opinions are divided; in the interests of consistency and comparability, and pending further investigations to resolve this question, the use of a salinity enhancement of 5psu, as per the previous JGOFS protocols, is recommended at least for long-term moorings aiming to contribute to the global flux database. Excess density solutions should exist only in the sample collection area owing to their effect on trap aspect ratio (section 4: US GOFS Working Group, 1989). For short-term study-specific deployments, individual laboratories and collaborating groups should decide. Non-particle reactive components in trap solutions may provide useful information in quantifying diffusive and advective losses.

8.0 Post-collection Procedures

- 8.1 *Handling and Storage:* Samples are to be isolated under non-contaminating conditions (dependent on intended analytes) immediately following trap recovery. The sample cup solution supernatants are sub-sampled and stored as is appropriate for the analysis of components that may have leached from the collected particulates (section 8.5). Storage prior to separation of particles from solution should be under refrigeration in the dark.
- 8.2 *Description and Swimmer Picking:*
- 8.2.1 The wet sample is inspected and qualitatively described using an optical dissecting microscope (magnification up to about x50). Swimmers - those organisms deemed to have actively entered the trap - must be removed. Swimmers may be picked out with forceps during microscopic inspection. Alternatively, samples may be first screened to remove large swimmers, followed by microscopic inspection and picking of both fractions to ensure that (a) swimmers smaller than the mesh size are removed, and (b) that non-swimmer particles retained by the sieve are not removed. Picked swimmer data are to be recorded as organism category, sizes, numbers, and an estimate of total swimmer volume as a fraction of sample volume.
- 8.2.2 It is recognized that to some extent a swimmer is operationally-defined and dependent in some degree on the sample type. The general recommendation is to remove intact, recognizable zooplankton greater than 330 microns in size. Beyond this, laboratories should consider potential contamination by "cryptic swimmers" (Michaels *et al.* 1990) - swimmers that are difficult to see or remove, or structures such as feeding webs brought into the trap by a swimmer - and the effects of removing zooplankton that may be part of the passive flux. The identification and removal of small and cryptic swimmers is particularly difficult if samples are filtered or centrifuged before picking; separation of particles from solution prior to picking is thus not recommended. Individual laboratories should take responsibility for swimmer identification strategy based on sample type.
- 8.3 *Subdivision of Samples:*
- 8.3.1 When a trap sample is intended for several analyses, subdivision must produce subsamples that are compositionally representative of the original sample. A rotating, high precision plankton splitter has been shown to be effective for wet samples (Honjo 1978). Other methods can be used if their precision is demonstrated.
- 8.3.2 The impact of rare large particles on split precision with respect to certain components should be considered.

8.4 *Particulate Components to be Analyzed:*

- 8.4.1 Determination of dry mass, total carbon, organic carbon, inorganic carbon, total nitrogen, total phosphorus, total silicon.
- 8.4.2 Additional analyses might include biogenic and non-biogenic silicon, organic and inorganic nitrogen, aluminium, appropriate radionuclides, stable isotopes, organic biomarkers, lithogenic components, trace elements, other major elements, detailed microscopic examination, etc.

8.5 *Dissolved Components to be Analyzed*

- 8.5.1 The analysis of trap solution supernatants (section 8.1) and sample cup solution blanks (section 7.3) for all components analysed in the particulate phase, plus pH. The solution phase should also be sampled when the particles are isolated, and similarly analysed. Organic carbon (and possibly nitrogen) contamination from the formalin preservative precludes the analysis of this (these) component(s).
- 8.5.2 Different dissolved species (e.g. N and P species) may be differentiated if speciation changes due to sample handling and storage artifacts can be assessed. Given such solution phase analyses, corrections for components leached from collected particulates can be applied if it is assumed that dissolved material is not lost from the high density solution during deployment, and with the caveat that the impact of swimmers on solution phase composition should be considered. The determination of natural dissolved organic carbon is not presently feasible in the presence of formalin. An organic carbon leaching correction cannot therefore be determined. However, estimates of carbon fluxes using preservatives are generally considered to be more reliable than those measured without preservation (section 7.3). pH determination checks effectiveness of preservative buffering and enables assessment of the possibility of significant carbonate dissolution.

8.6 *Analytical Methods*

- 8.6.1 Mass determination is by filtration onto preweighed 0.2-0.5 μm filters, removal of sea salt by buffered (pH 7-10) rinsing, drying at $< 60^\circ\text{C}$ and reweighing. Alternatively, filtered solids can be resuspended in the rinse solution in a preweighed bottle, freeze-dried and reweighed.
- 8.6.2 Particulate total carbon and nitrogen are determined by the detection of the gaseous by-products of high-temperature combustion of weighed subsamples of similarly filtered, rinsed and dried samples.
- 8.6.3 Particulate organic carbon is measured by the same high-temperature combustion method following the removal of the inorganic carbon.
- 8.6.4 Methods to be used for the determination of other analytes are as given in the JGOFS protocols, where appropriate; otherwise according to the judgement of

individual and collaborating laboratories and programs. The community should work towards establishing common analytical protocols as methodologies improve. The state-of-the-art of particle analysis is described by Hurd and Spencer (1991).

8.7 *Comments:*

- 8.7.1 Mass determinations should aim for the rinsing solution to be isotonic with respect to seawater to minimize potential mass losses owing to cell lysis.
- 8.7.2 Of the several methods for inorganic carbon removal, none reliably remove 100% of the inorganic phase whilst leaving 100% of the organic phase. Whilst it is recommended that the inorganic carbon is removed by direct treatment with, preferably, sulphurous acid (Verardo et al. 1990), owing to the less oxidizing nature of this acid compared to HCl, it is realized that until existing and new methods are further assessed and improved, some laboratories will prefer to continue fuming samples with HCl. Care should be taken not to lose organic carbon that is solubilized by the direct acid treatments. Methods used should be reported when presenting data.

9.0 **Calculation and Expression of Results**

Downward particulate flux estimates should be expressed in units of quantity per horizontal area per time. Attempts should be made to correct data for dissolution of collected particles using dissolved phase and cup solution blank concentrations and swimmer data (sections 8.2 and 8.5). All reported sediment trap data should be accompanied by reports of: trap geometry and baffle configuration; current and other mooring sensor data summaries; trap solution preparation methods; swimmer removal criteria, procedures and estimated volume contribution to total sample; sample subdivision method; analytical methods; details of corrections for dissolution of collected particles and possible leaching from swimmers; estimated precision of sample processing and analytical procedures.

10.0 **Quality Control/Quality Assessment**

In order to improve quality control and quality assessment of sediment trap data, efforts should be focussed on: mooring sensor development and sensor data interpretation (section 5); trap and mooring design and development; replicate traps; horizontal-scale variability of fluxes; the verification and application of trap calibration by radio- nuclide trapping efficiency integrated over long time-series'; swimmer prevention; swimmer removal and impact assessment; precision of sample subdivision methods; suitability, accuracy and precision of analytical methods; estimated overall precision of sample processing and analytical procedures.

An area of particular concern is the compromising of samples by swimmers. Efforts should be directed towards their exclusion from traps during deployment (e.g. Coale 1990). If swimmers do contaminate a sample, an assessment of their likely impact should be attempted e.g. within-trap solution activity, effects of leaching, effects of activity of swimmers colonizing trap but not trap solution. The difficulty of swimmer impact assessment necessitates the reporting of swimmer data (sections 8.2, 9).

11.0 Intercomparison

Intercomparisons should be encouraged in the areas of: trap design; mooring design; sample processing; analytical methods. Increased collaboration between groups in planning deployments and discussing methods is desirable. Some such intercomparisons are presently underway, but there is scope for much further work. The offer of S. Honjo (WHOI) to provide a bulk homogenized “standard” of sediment trap material to the international community for analytical methods intercomparisons and intercalibrations should be taken up; the participation of a large number of laboratories in such a comparison would be invaluable.

12.0 Notes

At all stages of the sediment trapping experiment (trap and mooring design, trap preparation, deployment, sampling, recovery, storage, sample handling and analysis) attention must be paid to avoiding contamination of the samples with intended analytes or components interfering with their analysis.

13.0 References

- Baker, E. T., Milburn, H. B. and Tennant, D. A. (1988). Field assessment of sediment trap efficiency under varying flow conditions. *J. Mar. Res.* **46**: 573-592.
- Coale, K. H. (1990). Labyrinth of doom: A device to minimize the “swimmer” component in sediment trap collections. *Limnol. Oceanogr.* **35**: 1376-1381.
- Honjo, S. (1978). Sedimentation of materials in the Sargasso Sea at 5367m deep station. *J. Mar. Res.* **36**: 469-492.
- Hurd, D. C. and Spencer, D. W. (1991). Editors; Marine Particles: Analysis and Characterization. *Geophysical Monograph 63*. AGU. Washington DC. 472p.
- Knauer, G. A., Karl, D. M., Martin, J. H. and Hunter, C. N. (1984). *In situ* effects of selected preservatives on total carbon, nitrogen and metals collected in sediment traps. *J. Mar. Res.* **42**: 445-462.
- Lee, C., Hedges, J. I., Wakeham, S. G. and Zhu, N. (1992). The effectiveness of various treatments in retarding bacterial activity in sediment-trap material and their effects on the collection of swimmers. *Limnol. Oceanogr.* **37**:117-130.
- Michaels, A. F., Silver, M. W., Gowing, M. M. and Knauer, G. A. (1990). Cryptic zooplankton “swimmers” in upper ocean sediment traps. *Deep Sea Res.* **37**: 1285-1296.
- US GOFS Working Group (1989). Sediment Trap Technology and Sampling. Planning Report No. 10. November 1988. WHOI, USA.
- Verardo, D. J., Froelich, P. N. and MacIntyre, A. (1990). Determination of organic carbon and nitrogen in marine sediments using the Carlo Erba NA-1500 Analyser. *Deep Sea Res.* **37**: 157-165.

Chapter 25. Trap-Collected Particle Flux with Surface-tethered Traps

1.0 Scope and field of application

This procedure describes a method for the determination of the sinking fluxes of particulate matter and particulate carbon and nitrogen in seawater, expressed as $\text{mg}/\text{m}^2/\text{day}$. The method is suitable for the assay of all levels of sinking flux found in the ocean. It has been modified from the methods currently in use at the Bermuda Atlantic Time-series Study and the Hawaii Ocean Time-series Study. It was developed by Knauer et al. (1979) and used extensively in the VERTEX program. As described here, this method does not conform to all of the recommendations of the U.S. JGOFS Planning Report #10 on sediment trap sampling and technology. It is presented as an example of a widely-used technique. There is no consensus in the JGOFS community on the appropriate methods for trapping.

Sediment traps are the only tool for directly collecting the rain of sinking particles in the ocean. They are largely uncalibrated in the field and there are significant unresolved questions on the accuracy and precision of sediment traps. Any investigators that decides to use sediment traps should become aware of all facets of this controversy and make their own decisions about the appropriate methods to use. The U.S. JGOFS Planning Report #10 provides an overview of these issues and there have been significant published papers on trap accuracy since that report.

2.0 Definition

2.1 Total particulate mass flux is defined as the amount of sinking particulate matter passing through a depth level as:

$$\text{Total Mass Flux} = \text{mg dry weight} / \text{m}^2 / \text{day}$$

2.2 Total particulate carbon flux is defined as the amount of sinking particulate organic carbon passing through a depth level as:

$$\text{Total Organic Carbon Flux} = \text{mg carbon} / \text{m}^2 / \text{day}$$

2.3 Total nitrogen mass flux is defined as the amount of sinking particulate organic nitrogen passing through a depth level as:

$$\text{Total Organic Nitrogen Flux} = \text{mg nitrogen} / \text{m}^2 / \text{day}$$

3.0 Principle of Analysis

Fluxes of sinking material are measured using sediment traps (Knauer *et al.* 1979). In this case, these are simple cylinders suspended at various depths from surface and subsurface floats. These cylinders collect sinking particles. It is assumed that the collection of particles is linearly related to the aperture area of the sediment trap and that this collection is an accurate

estimate of the mass of sinking particles at that depth and the particle sinking speeds. Hydrodynamic and other biases influence the collection of material by sediment traps and the interpretation of trap data should be approached with caution.

4.0 Apparatus

- 4.1 *Particle Interceptor Traps (PITs)*. The particle collection device central to the Multi-traps is a polycarbonate cylinder (cross-sectional collection area = 0.0039 m^2). The cylinder is equipped with a base which holds a 90 mm Poretics polycarbonate membrane filter. A PVC drain valve is mounted under the base of the filter holder. At the surface of the cylinder, plastic baffling consisting of circular openings 1.2 cm in diameter provide turbulence reduction at the trap opening. The cylinder also possesses two rings around its center which allow for mounting of the cylinder onto the PVC cross described below.
- 4.2 *Cross*. A PVC cross with cutouts to fit the PITs allows for mounting of up to 12 PITs at each depth. The cross is secured to the premeasured 1/2 inch polypropylene line by means of U-bolts which clamp onto the line and by 1/4 inch safety lines secured to the trap line below the cross with hose clamps. The prepared PIT cylinders are held in place on the cross by bungi cord retainers. Crosses with PITs are attached at 3 depths: 150, 200 and 300 meters.
- 4.3 *Flotation Gear*. At the surface the polypropylene line is attached to a stainless swivel, which is attached to a stainless steel chain with two 17 inch diameter glass floatation spheres covered by a polyethylene "hard hat" housing. The floats are attached to a 10 m double length of 1/2 inch bungi cord connected to a 5/8 inch double braided Duralon line with 8 orange polypropylene A2 floats. The entire flotation array is secured to the surface spar.
- 4.4 *Surface Spar*. The surface spar consists of a styrofoam core float with a central mast on which is mounted a VHF radio beacon (Novatech), strobelight (Novatech), and ARGOS transmitter.
- 4.5 *Current Meter*. The ambient flow at the trap mouth should be monitored for every trap depth. Any of a variety of commercial or custom built flowmeters can be used. At a minimum, the package should measure the current speed and direction, pressure and tilt. It should be able to resolve the high frequency variability in flow, pressure and tilt that might be transmitted down the line from surface wave motions. If only one flow package is available, it should be placed at the depth of optimum interest (usually the base of the euphotic zone).

5.0 Reagents

- 5.1 *Hydrochloric acid* (12N: Baker Instra-Analyzed): For making cleaning solutions
- 5.2 *Formalin* (reagent grade)

5.3 *Sodium chloride* (reagent grade)

5.4 *Density Gradient Solution.* A density gradient solution is used to reduce advective-diffusive exchange of trap contents with ambient seawater during deployment. The density gradient solution is prepared by adding 1 l formalin and 2.5 kg NaCl to 50 l seawater yielding a 2% formalin and 50g/l NaCl solution. The solution is gravity filtered through a 0.5 μm cartridge membrane filter (Millipore). A 1 liter portion of this gradient is saved for subsequent processing steps (see below). The PITs are filled with the density gradient solution and covered until deployment. All of these steps are controversial. Arguments persist about the amount of salt to add, the type of fixative, the height in the tube to fill with brine, etc.

6.0 Sampling

6.1 *Pre-sampling preparation:*

6.1.1 *Filter Preparation.* Poretics polycarbonate membrane filters (90 mm diameter, 0.8 μm pore size) are soaked overnight in 1.2N HCl (Baker Instra-Analyzed), rinsed with 1.2N HCl, rinsed three times with Milli-Q water, and then put in individual plastic petri dishes. The cleaned filters are oven dried (65° C for a couple of days), allowed to cool in a desiccator, and tared to constant weight on an analytical balance (Sartorius R160P).

6.1.2 *Trap Cleaning Procedure.* The porous polyethylene filter frit is rinsed in Milli-Q, soaked for 24 hours in 1.2N HCl, and rinsed with Milli-Q three times. All other trap parts are soaked overnight in a 5% dilution of Aquet Manostat detergent, rinsed thoroughly in tapwater to remove the detergent, soaked 24 hours in 0.6N HCl, and then rinsed in Milli-Q. The PITs are assembled while wearing latex gloves. The prepared Poretics filters are attached to the base of the polycarbonate cylinders together with the porous filter frit and covered by the filter holder with the PVC drain valve. Polyethylene tape is used to provide a leak-tight fit of the filter holder to the cylinder. The assembled PITs are stored in plastic bags until used.

6.2 *Deployment and Recovery:*

6.2.1 *Deployment.* The trap array is deployed for a minimum of 72 hours. Triplicate PITs are deployed at each of three depths (150, 200, 300 m). A non-functioning fourth PIT serves as a counterweight to balance the cross. Generally the array is deployed as the first cruise procedure (see Chapter 2). The location of the trap is checked periodically during the deployment.

6.2.2 *Recovery.* The traps are covered with polyethylene gloves before they are removed from the cross. The seawater at the top of the trap is siphoned off to just above the level of the visible density interface using acid-rinsed (0.6N HCl) Teflon tubing. The density gradient solution is drained through the bottom of the trap and discarded. The Poretics filter is removed, returned to its petri dish,

sealed with Parafilm and labeled. The filters are stored in the refrigerator until analyzed.

7.0 Sample Processing Procedures

- 7.1 *Picking Swimmers.* The “swimmers” (recognizable zooplankton) are removed using forceps under a dissecting microscope (12–50 power magnification). The filters are kept wet during this period by adding small volumes of the saved density gradient solution (see above). The zooplankton (down to less than 100 μm in size) should be removed with very fine-tipped forceps and placed into small vials with some of the reserve trap preservative. They can later be used to assess the effectiveness of swimmer removal (see below). Manual removal of swimmers is a time-consuming process and still may leave significant swimmer material behind (e.g. see Michaels et al., 1990). It is superior to screening or other indirect methods. Screening can remove very large passively sinking particles and will not remove swimmers that are smaller than the mesh. Picking swimmers is also a subjective exercise. Some labs remove only the largest zooplankton and some attempt to pick the samples at sea where the ship motion reduces the ability to discern the smaller zooplankton. As there is no absolute standard to compare sediment traps with, there is no absolute way to determine the effectiveness of the swimmer removal by any lab. In the BATS deployments, it generally takes 1–12 hours to remove the swimmers from **each** PIT tube after a three day deployment in that oligotrophic regime. (see below for additional techniques to assess the swimmer problem).
- 7.2 *Mass Flux.* The material on the filter is scraped into a bolus at the center of the filter with a scalpel and salts are removed by rinsing with Milli-Q water adjusted to pH 9 with ammonium hydroxide. The filter with the sample bolus is oven dried (65°C), placed in a dessicator and weighed daily until weight is constant for 2 consecutive weighings.
- 7.3 *Particulate Carbon and Nitrogen Analysis.* Carbon and nitrogen analyses are performed using a Control Equipment Corporation (CEC) 240 XA elemental analyzer calibrated with acetanilide. The bolus is scraped off the filter with a scalpel and ground in an agate mortar. The whole sample (50–300 μg) is transferred to a silver boat and weighed on a CAHN Electrobalance (Model 4400). The silver boats are put in wells drilled in a Teflon block, and fumed with concentrated HCl for 36 hours to volatilize inorganic carbon. The fumed boats are desiccated overnight and then analyzed for total nitrogen and organic carbon. The results from the C/N analysis yield %C and %N.

8.0 Calculation and expression of results.

- 8.1 *Mass flux.* The mass flux is calculated as follows: The mass weight minus the tare weight of the filter divided by the number of days deployed and the by the trap cross-sectional area (0.0039 m^2) equals the mass flux ($\text{mg m}^{-2} \text{ d}^{-1}$).

$$\text{Mass flux (mg/m}^2\text{/day)} = \frac{\text{mass weight} - \text{filter weight}}{\text{days deployed} \times \text{trap area}}$$

- 8.2 *Particle flux.* C/N analysis yield %C and %N determinants. Particulate flux (mgN or $\text{mgC m}^{-2} \text{ d}^{-1}$) is then calculated by multiplying the %C or %N by the mass flux.

$$\text{Particle flux (mgN or mgC)} = \text{Mass flux} \times \%C \text{ (or \%N)}$$

9.0 Quality Control and Assessment

- 9.1 *Hydrodynamics.* Although there are few field data, published reports indicate that flows above 15 cm/s at the trap mouth probably cause biases in trap collection. There is a large, but insufficient, literature on trap hydrodynamics (see U.S.JGOFS Planning Report # 10).
- 9.2 *Swimmers.* The effectiveness of swimmer removal can be determined by examining a replicate PIT sample (different tube) with different techniques. The swimmer tube(s) should be deployed in the same way as the mass flux tubes. On recovery, the entire tube contents (after siphoning the upper, exchanged solution) should be transferred to a sample bottle (about 1 l of liquid). This solution should be allowed to settle for a few days, then the supernatant gently siphoned off. By repeating this process, the sample can be gently concentrated down to a manageable volume (size will depend on the amount of material). This sample can then be counting in much the same way as a plankton tow. The numbers and sizes (values that can be converted to biovolumes or carbon units) of zooplankton can be counted on both a dissecting microscope and an inverted compound microscope using quantitative techniques. The picked swimmers from each of the mass flux traps can then be counted with the same techniques (they should have been saved after removal from the filters). By comparing the zooplankton in the complete sample(s) with the zooplankton actually removed, the biovolume of unremoved zooplankton can be calculated. Some zooplankton from each of the dominant unremoved swimmer taxa should then be measured for biovolume and carbon content to create a conversion factor for relating the unpicked biovolume to the total measured carbon. This allows a first-order correction for the residual swimmer problem. In practice it is often of similar magnitude as the passive flux in shallow traps (Michaels et al., 1990).

10.0 References and Related Literature

- Baker, E. T., Milburn, H. B. and Tennant, D. A. (1988). Field assessment of sediment trap efficiency under varying flow conditions. *J. Mar. Res.* **46**: 573-592.
- Coale, K. H. (1990). Labyrinth of doom: A device to minimize the “swimmer” component in sediment trap collections. *Limnol. Oceanogr.* **35**: 1376-1381.
- Honjo, S. (1978). Sedimentation of materials in the Sargasso Sea at 5367m deep station. *J. Mar. Res.* **36**: 469-492.
- Hurd, D. C. and Spencer, D. W. (1991). Editors; Marine Particles: Analysis and Characterization. *Geophysical Monograph 63*. AGU. Washington DC. 472p.
- Knauer, G.A., J.H. Martin and K.W. Bruland. (1979). Fluxes of particulate carbon, nitrogen and phosphorus in the upper water column of the northeast Pacific. *Deep-Sea Research* **26A**:97-108.
- Knauer, G. A., Karl, D. M., Martin, J. H. and Hunter, C. N. (1984). In situ effects of selected preservatives on total carbon, nitrogen and metals collected in sediment traps. *J. Mar. Res.* **42**: 445-462.
- Lee, C., Hedges, J. I., Wakeham, S. G. and Zhu, N. (1992). The effectiveness of various treatments in retarding bacterial activity in sediment-trap material and their effects on the collection of swimmers. *Limnol. Oceanogr.* **37**:117-130.
- Michaels, A. F., Silver, M. W., Gowing, M. M. and Knauer, G. A. (1990). Cryptic zooplankton “swimmers” in upper ocean sediment traps. *Deep Sea Res.* **37**: 1285-1296.
- US GOFS Working Group (1989). Sediment Trap Technology and Sampling. Planning Report No. 10. November 1988. WHOI, USA.
- Verardo, D. J., Froelich, P. N. and MacIntyre, A. (1990). Determination of organic carbon and nitrogen in marine sediments using the Carlo Erba NA-1500 Analyser. *Deep Sea Res.* **37**: 157-165.

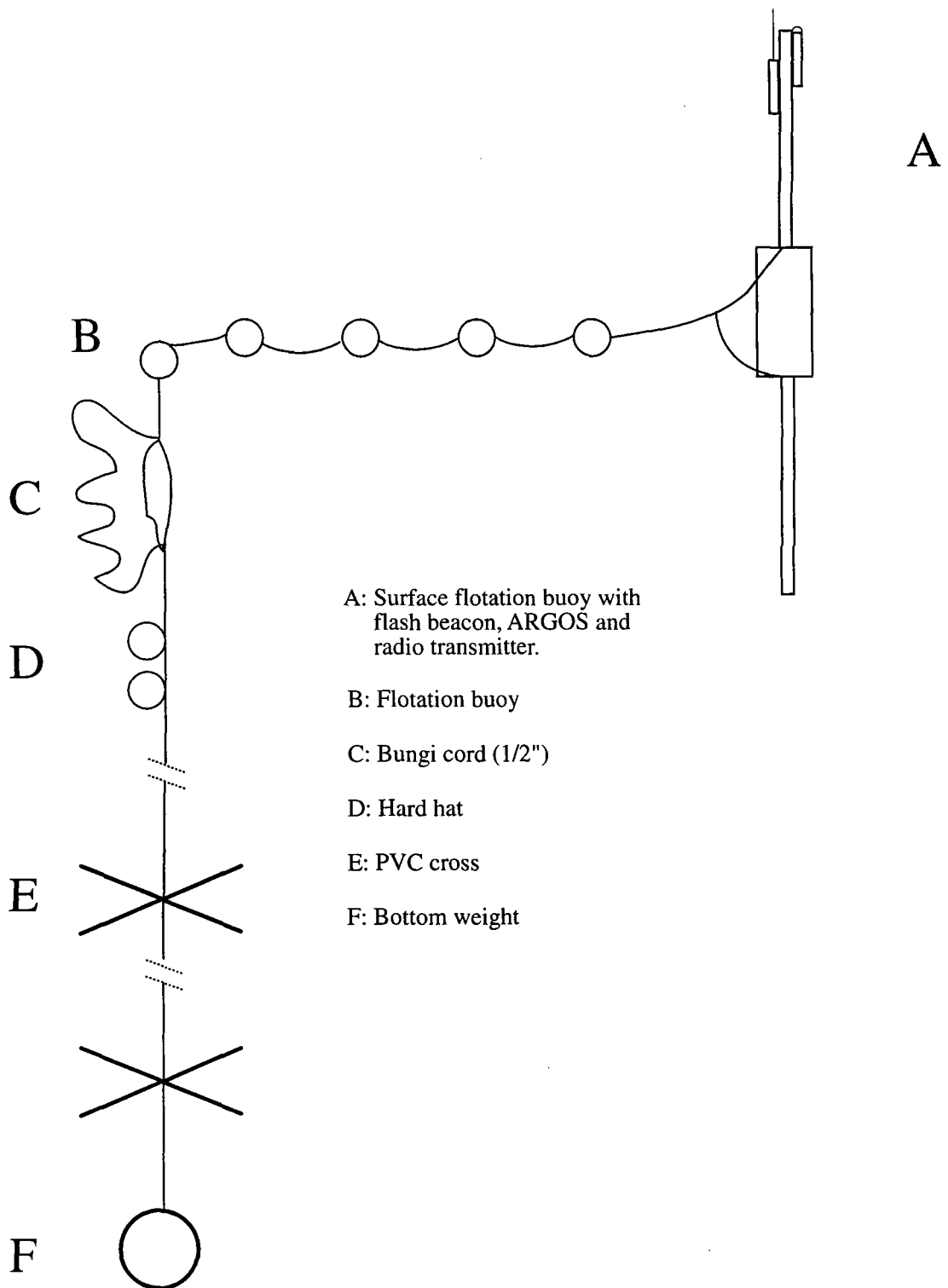

Figure 25.1. The surface-tethered trap array.