

# GUIDE FOR DESIGNING AND IMPLEMENTING A PLAN TO MONITOR TOXIN-PRODUCING MICROALGAE

Second Edition



**Beatriz Reguera, Rosalba Alonso, Ángel Moreira,  
Silvia Méndez and Marie-Yasmine Dechraoui Bottein**

**GUIDE FOR DESIGNING AND IMPLEMENTING A PLAN  
TO MONITOR TOXIN-PRODUCING MICROALGAE**

**Second Edition**

Editors

Beatriz Reguera, Rosalba Alonso, Ángel Moreira, Silvia Méndez  
and Marie-Yasmine Dechraoui Bottein

The designations employed and the presentation of the material in this publication do not imply the expression of any opinion whatsoever on the part of the Secretariats of UNESCO and IOC concerning the legal status of any country, territory, or its authorities, or concerning the delimitations of the frontiers of any country or territory.

**For bibliographic purposes, this document should be cited as follows:**

Reguera, B., Alonso, R., Moreira, A., Méndez, S., Dechraoui-Bottein, M.-Y. (Eds). 2016. Guide for designing and implementing a plan to monitor toxin-producing microalgae. 2<sup>nd</sup> Ed.  
Intergovernmental Oceanographic Commission (IOC) of UNESCO and International Atomic Energy Agency (IAEA), Paris and Vienna.  
IOC Manuals and Guides, no. 59.  
66 pages  
(Spanish and English)

The first edition of this manual was first published in 2011 in Spanish.

Published in 2016  
by the United Nations Educational, Scientific and Cultural  
Organization  
7, Place de Fontenoy, 75352, Paris 07 SP

UNESCO 2016

(IOC/2011/MG/59Rev).

# Contents

Preface	3
1 Introduction	5
Harmful algal blooms	5
Harmful algal blooms in Latin America and the Caribbean	6
2 Designing a plan to monitor potentially toxic microalgae: General guidelines and methods	9
Introduction	9
Choosing the sampling sites	9
Sampling frequency	10
Materials and methods for sampling phytoplankton and environmental conditions	10
Temperature and salinity: Multiparameter probes and CTDs	11
Transparency: The Secchi disk	12
Plankton nets	13
Water-sampling bottles	14
Tubes and hose-samplers	15
Fixatives and preserving agents for plankton samples	18
3 Methods for sampling benthic microalgae	19
Introduction	19
Collecting the substrate sample (macroalgae)	19
Detachment and preservation	21
Artificial substrate method for collecting benthic dinoflagellates	23
4 Materials and methods for sampling phytoplankton and phytobenthos for toxin analysis	31
Protocol 1	31
Protocol 2	33
Protocol 3	33
5 Quantitative analysis of microalgae: General considerations	35
Counting cells with Sedgewick-Rafter chambers	36
The Utermöhl method using sedimentation chambers	37
Calibrating counting systems and quality control of analyses	41
6 Steps for identifying microalgae that cause toxic events	43
Toxin analysis of molluscs	43
Toxin analysis of plankton	43
Toxin analysis of monoalgal cultures	44
Interpretation of the results and a list of common mistakes	45
7 Preparing mollusc flesh for toxin analysis	47
Extracting soft tissue from organisms for phycotoxin analysis	47
Homogenizing and freeze-drying oyster tissue	47
Grinding, packaging and sealing the freeze-dried tissue	49
8 Practical sampling guidance for determination of ciguatoxin in fish	51
Introduction	51
Sampling strategy	57
Sample processing	58
Sample shipment	61

## Preface

Marie-Yasmine Dechraoui Bottein<sup>1</sup>, Henrik Enevoldsen<sup>2</sup>

<sup>1</sup>International Atomic Energy Agency, Environment Laboratory, 4 Quai Antoine 1er, MC-98000, Monaco, Monaco

<sup>2</sup>Intergovernmental Oceanographic Commission of UNESCO, IOC Science and Communication Centre on HAB, Denmark

Toxin-producing Harmful Algal Blooms (HABs) constitute a serious threat to public health as well as sustainable coastal and marine development. Reports on the socio-economic impacts of HABs from many parts of the world are increasing in parallel with increased tourism, aquaculture exploitations, or artisanal fisheries in many coastal and marine areas. Observations and time series on HAB occurrences and associated biotoxins are, in addition to the immediate use for protection of public health, international seafood trade and of natural resources, a valuable source of data to document and understand both natural and anthropogenic driven ecosystem change.

Prompted by the concern of its Member States about increasing impacts of HABs, an international programme on *Harmful Algal Blooms* was established by the Intergovernmental Oceanographic Commission (IOC) of UNESCO in 1992, with the overall objective *to foster the effective management of, and scientific research on, harmful algal blooms in order to understand their causes, predict their occurrences, and mitigate their effects*. Objectives have been expanded to develop and improve methods to minimize the environmental and economic consequences of harmful algae and to promote and facilitate the development and implementation of appropriate monitoring programmes, thereby to protect public health and ensure seafood quality (<http://ioc-unesco.org/hab/>).

Following a request made by Member States during the International Atomic Energy Agency (IAEA) General Conference in 1997 to address the impacts of HABs, a first Technical Cooperation project was initiated to assist Member States in strengthening their capacities to control and mitigate the health and socio economic impacts of HABs. The IAEA, through its Technical Cooperation Program and its Nuclear Application Department, has since then supported the development and validation of sensitive and selective nuclear-based techniques for monitoring HABs and related biotoxins in seafood or the environment, and facilitated the transfer of such technologies to close to 40 Member States in Africa, Asia, Asia Pacific, and Latin America and the Caribbean regions ([www.iaea.org/nael](http://www.iaea.org/nael)).

In 2009, a 4-year IAEA TC project was initiated on *Designing and Implementing Systems for Early Warning and Evaluation of the Toxicity of Harmful Algal Blooms in the Caribbean Region, Applying Advanced Nuclear Techniques, Radioecotoxicological Evaluations and Bioassays* (ARCAL RLA/7/014) was established. The Project was implemented with the support of Spain and United States in cooperation with the IOC and included an *IAEA-IOC Training course on Taxonomy of potentially toxic microalgae; Design and implementation of a monitoring programme organized by the IOC Science and Communication Centres on Harmful Algae* (Vigo and Copenhagen) and Dr. Jacob Larsen at the University of Copenhagen. Results from this project and its capacity development activities included the publication of a manual in Spanish to strengthen capacities to monitor HABs events and to mitigate their deleterious effects; Reguera, B., Alonso, R., Moreira, A., Méndez, S. 2011. Guía para el diseño y puesta en marcha de un plan de seguimiento de microalgas productoras de toxinas. COI de UNESCO y OIEA, Paris y Viena 2011. Manuales y Guías de la COI, 59.

With the initiation of additional IAEA national and regional projects on HABs, the organization of regular IOC global and regional training courses, and the strengthened cooperation between the IOC and the IAEA on board capacity development, the need developed to translate this HABs manual into English, and expand it with the addition of chapters related to benthic HAB species. This was a natural next step to assist Member States to implement monitoring programmes to detect potentially toxic HABs species in their respective coastal waters. This manual is intended as an introduction to basic analytical techniques that can be applied when designing a standard sampling protocol for both planktonic and benthic microalgae (and associated environmental conditions) and vectors of biotoxins (shellfish and fish). This standardization of methods will enable more robust data comparisons between countries and will yield improved risk assessments of potentially toxic HABs events.

This Manual is a joint product of the IAEA and the IOC of UNESCO. The IAEA and the IOC express their profound gratitude to the highly committed editors Beatriz Reguera (Spain), Rosalba Alonso (Mexico), Ángel Moreira (Cuba), Silvia Méndez (Uruguay), who also contributed as authors; to the expert authors that prepared the original manuscript in Spanish and the updated version in English: and to Laura-Victoria Perdomo and Andrés-Leonardo Malagón (Colombia), Jaime Espinoza (El Salvador), and Leonel Carrillo (Guatemala) who revised the first (Spanish) edition; to Patricia Tester (USA) as a new co-author of chapter 3 in this second (English) edition, and to Mireille Chinain (French Polynesia) and Rachel Clausing (IAEA) who contributed with a new chapter 8 for this second edition.

This publication was funded under the US Peaceful Use Initiative within the framework of the International Atomic Energy Agency (IAEA) Technical Cooperation Project RAS7026 and through IOC UNESCO Regular Programme for the Harmful Algal Bloom Programme. The International Atomic Energy Agency is grateful to the Government of the Principality of Monaco for the support provided to its Environment Laboratories.

Marie-Yasmine Dechraoui Bottein  
International Atomic Energy Agency  
Environment Laboratories, Monaco

Henrik Enevoldsen  
Intergovernmental Oceanographic Commission of UNESCO  
IOC Science and Communication Centre on HAB, Denmark

# 1 Introduction

Rosalba Alonso<sup>1</sup>, Ángel Moreira<sup>2</sup>, Silvia Méndez<sup>3</sup> and Beatriz Reguera<sup>4</sup>

<sup>1</sup>Universidad Nacional Autónoma de México, Unidad Académica Mazatlán, Av. Joel Montes Camarena s/n, Col. Playa Sur, Mazatlán, 82040 Sinaloa, México

<sup>2</sup>Centro de Estudios Ambientales de Cienfuegos, Apartado Postal 5, Ciudad Nuclear, 59350 Cienfuegos, Cuba.

<sup>3</sup>Dirección Nacional de Recursos Acuáticos, Constituyente 1497, 11200 Montevideo, Uruguay

<sup>4</sup>Instituto Español de Oceanografía, Subida a Radio Faro 50, 36390 Vigo, Spain

## Harmful algal blooms

Pigmented phytoplankton is the main primary producer and constitutes the foundation of the marine food webs. Blooms, the explosive growth of phytoplankton, are natural phenomena that help to support the production of bivalves and small pelagic fish such as sardines and anchovies. Through photosynthesis, phytoplankton synthesizes organic material using solar energy, macronutrients — atmospheric CO<sub>2</sub> and nitrates, phosphates and silicates dissolved in the water — and trace elements (e.g. trace metals and vitamins). In this way, phytoplankton growth acts like a “biological carbon pump” that helps to offset the greenhouse effect. In addition, phytoplankton populations excrete dimethyl sulphide (DMS) into the atmosphere, a gas that contributes to the formation of nuclei of condensed water, thus generating clouds and counteracting excessive solar radiation.

Not all of these blooms are beneficial, however. Harmful algal blooms (HABs) is a term adopted by the Intergovernmental Oceanographic Commission (IOC) of UNESCO; it is internationally accepted to refer to any proliferation of microalgae (regardless of the concentration) perceived as harmful owing to its negative impact on public health, aquaculture, the environment and/or recreational activities.

Red tides are discoloured patches of seawater resulting from the presence of high concentrations — 1 or more million cells per litre — of planktonic microalgae (Fig. 1). The colour, which depends on the pigments in the microalgae, can be

greenish, brown, reddish, orange and so forth. In the majority of cases, red tides are formed by innocuous microalgae and do not constitute any danger for the ecosystem if occurring in open areas with a good rate of water renewal. Nonetheless, they can be detrimental if they form in bays and narrow coves with little circulation and occur under any of the following circumstances:

- If the high biomass of phytoplankton is not consumed, it settles and decomposes, resulting in an anoxic seabed, pestilent odours and the death of organisms living on the sea bottom (benthos). Systems of this type, in which excessive primary production, as compared with consumption, leads to an unbalance, are called eutrophic.
- If patches form on small beaches and bays frequented by tourists, they can create visual pollution and social alarm if the public is not properly informed (Fig. 2).
- If they occur in areas where fish are farmed in cages, the fish can die because of: a) abrupt changes to the physico-chemical conditions due to the high biomass of microalgae, such as anoxia, hyper-oxygenation, decreased pH and/or high concentrations of excreted ammonium; b) the excretion of mucilaginous substances by microalgae, which increases water viscosity, obstructs gills and restricts oxygen absorption; and c) the presence of prickles and other appendices on microalgae, which damage the gills of fish and increase their vulnerability to bacterial and viral infections.

Some microalgal species produce potent poisons or toxins. When these microalgae are filtered by mussels and other bi-

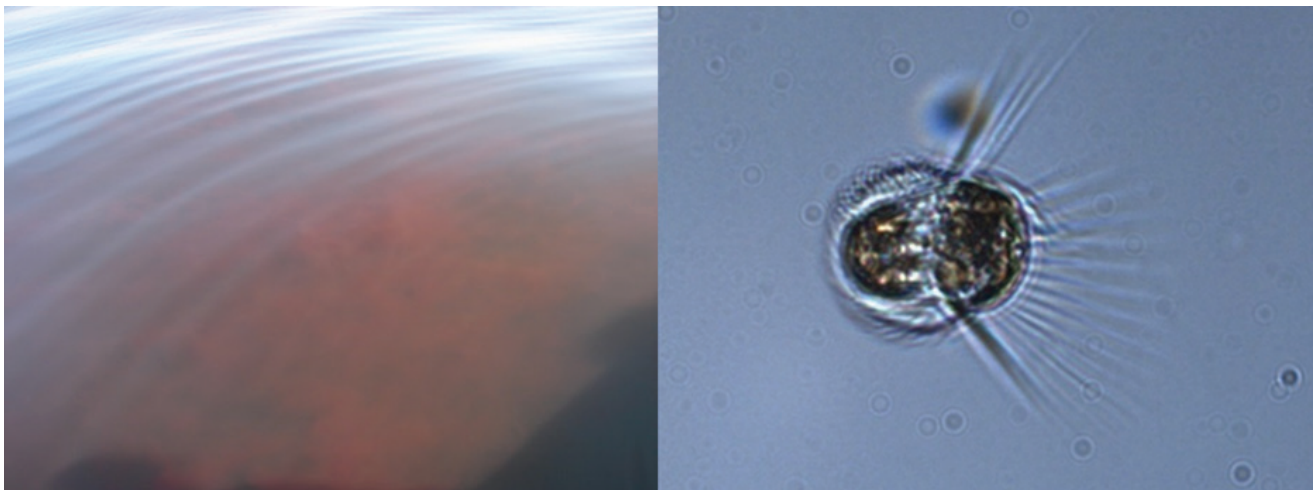

**Figure 1.** Red tide (left) of the photosynthetic ciliate *Mesodinium rubrum* (right) in the Bay of Mazatlán, Sinaloa, Mexico. The discoloration, with no apparent adverse effect on the biota, was observed from 11 to 20 January 2009 (Photo: R. Alonso).



**Figure 2.** Red tide of *Noctiluca scintillans* in Punta del Este, Uruguay, November 2003. This HAB had no harmful or toxic effect on human beings or marine organisms. Nonetheless, since it occurred in a major tourist area, it created social alarm (Photo: S. Méndez).

valves, the toxins accumulate in their tissues and are transmitted to higher levels of the food chain, including to human beings. The toxins are so powerful that even at low microalgal concentrations ( $10^3$ - $10^4$  cell  $L^{-1}$ ) and without forming patches in the water, they can make bivalves unfit for consumption. Such proliferations, which are rarely accompanied by high biomass production, are called Harmful Algal Events. Shellfish poisoning can then occur, which in extreme cases results in hospitalizations and even the loss of human life. Such poisoning and syndromes are classified according to the biological effects in the organism. In the region, the most common types are paralytic shellfish poisoning (PSP), diarrhetic shellfish poisoning (DSP), amnesic shellfish poisoning (ASP) and neurotoxic shellfish poisoning (NSP).

Bivalves are not the only vectors of microalgal toxins. Another possible transmission path that affects birds and marine mammals is through small plankton-eating pelagic fish (e.g. sardines, anchovies), resulting in poisoning of varying intensity, from minor symptoms to death. Moreover, it should be mentioned that, unrelated to phytoplankton, some HABs are caused by benthic microalgae that adhere to macroalgae (epiphytes) or other types of substrates. The most well-known are those causing ciguatera fish poisoning (CFP), which is endemic to tropical regions. It is caused by microalgae (*Gambierdiscus* spp.) that live on coral reefs and are transmitted, via small herbivorous fish, to larger edible fish (e.g. barracudas and others). Another example of benthic HABs are blooms of *Ostreopsis* spp, whose toxins, released into the seawater, enter the sea spray and irritate swimmers' respiratory tracts and skin. Lastly, the impact of cyanobacterial blooms in freshwater ecosystems and brackish waters should not go unmentioned.

The above illnesses are caused by the following groups of toxins of microalgal origin:

- Paralytic shellfish toxins (PST), produced by dinoflagellates of the genera *Alexandrium*, *Gymnodinium* and *Pyrodinium*
- Diarrhetic shellfish toxins (DST), pectenotoxins and yessotoxins. Diarrhetic toxins (okadaic acid and dinophysistoxins) are produced by dinoflagellates of the genus *Dinophysis* and benthic species of the genus *Prorocentrum*.

Pectenotoxins are produced by *Dinophysis* spp., and yessotoxins by *Gonyaulax spinifera*, *Lingulodinium polyedrum* and *Protoceratium reticulatum*.

- Amnesic shellfish toxins (AST), produced by diatoms of the genera *Pseudo-nitzschia* and *Nitzschia*.
- Neurotoxic shellfish toxins (NST), produced by species of the genus *Karenia*, such as *K. brevis* in the Gulf of Mexico. Their effects include production of toxic sea spray causing respiratory tracts and skin irritation.
- Ciguatoxins (CTX), produced by benthic dinoflagellates of the genus *Gambierdiscus*.
- Cyanotoxins, produced by cyanobacteria.

There are also ichthyotoxic microalgal blooms that produce haemolytic toxins or oxidizing substances (reactive oxygen species – ROS) that are released into the environment and can kill both wild and farmed fish. The proliferation of these species can have devastating effects on marine-cage fish farms. Deaths of salmonids and other farmed fish have been widely reported, caused by blooms of small raphidophyte flagellates, such as *Heterosigma akashiwo* (known in Chile as a “coffee tide”) and various species of the genus *Chattonella*, responsible for fish kills in the Gulf of California in Mexico.

Based on the harm that they cause, we have classified the HABs mentioned here into the following groups:

- Non-toxic algal blooms with high biomass that can cause physiochemical damage
- Blooms producing toxins that are transferred through the food chain
- Ichthyotoxic algal blooms
- Microalgal blooms producing toxins that are transferred through sea spray, causing irritations
- Cyanobacterial harmful algal blooms (CHAB)

It should be noted that some HABs can have multiple adverse effects. The most notorious example is the dinoflagellate *Karenia brevis* in the Gulf of Mexico. Its neurotoxins, which cause neurotoxic shellfish poisoning (NSP), are transferred through the food chain and can kill marine mammals. Its high-biomass blooms cause massive deaths of bottom-dwelling marine organisms and, moreover, the toxins are transmitted to sea spray, irritating swimmers' respiratory tracts and skin (see Mexico's report in IOC 2008).

## Harmful algal blooms in Latin America and the Caribbean

Reports of the socioeconomic impacts from HABs in Latin American and Caribbean countries have been increasing at the same time as the growing use of coastal areas for tourism and aquaculture. In the region, there are examples of all the types of HABs (IOC 2008, IOC 1995) mentioned in the section above, but those that have the worst socioeconomic impact are HABs of toxin-producing microalgae that, even at moderate concentrations (i.e., not forming patches), cause accumulation of toxins in bivalves and fish and their transfer through the food chain. Such toxic microalgal events are a threat to public health and to the utilization of marine resources. The situation can be particularly serious: a) in coastal zones where seafood and fish are a usual component of the lo-



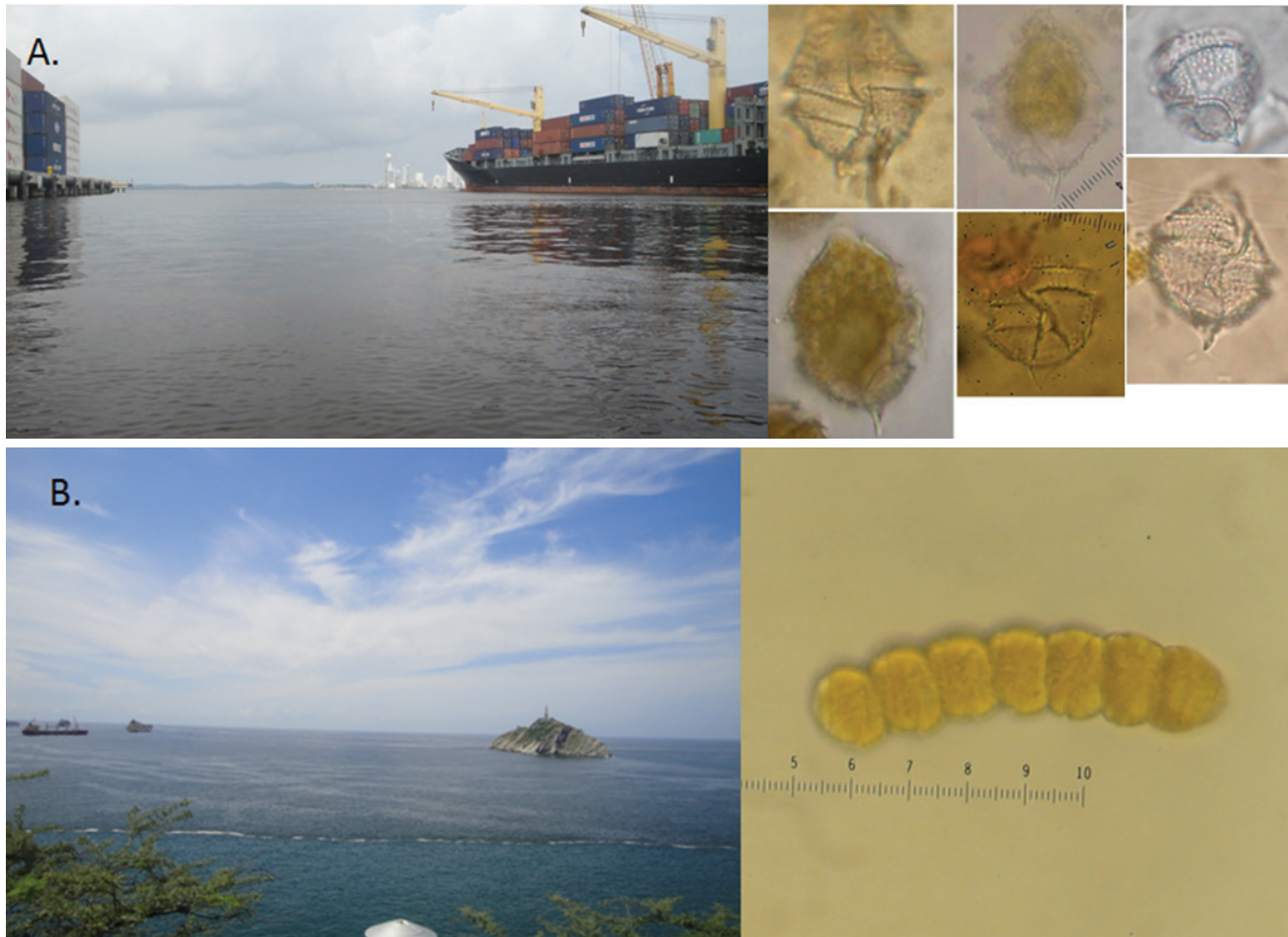

**Figure 3.** Red tides in Colombia in 2010, both with no harmful effect on human health or marine organisms. A: Red tide produced by *Gonyaulax cf. polygramma* (micrographs on the right) in May, associated with high levels of oxygen, ammonium and phosphates as compared with historical records. B: Extensive red tide generated by *Cochlodinium polykrikoides* (micrograph on the right) in the Bay of Santa Marta area, Colombia, in October.

A major challenge faced by specialists is to succeed in raising awareness among the health and fishery authorities of their respective countries as regards the nature of the problem and the need to establish early warning programmes. Such programmes will contribute to:

1. Improving the management of toxic events, which have serious consequences, including the loss of human life
2. Designing contingency plans to mitigate the impact of toxic events on shellfish resources, small-scale fishing and tourism.

cal diet and where no public health programme on food safety exists for fishery products; and b) if the lack of such health inspections leads to the banning of exports to third countries (e.g. the United States, the European Union) accompanied by strict regulatory measures.

The accumulation of paralytic shellfish toxins (PST) associated with blooms of *Pyrodinium bahamense* var. *compressum* along the Pacific coast and of *Gymnodinium catenatum*, along both

the Pacific and Caribbean coasts, has resulted in hundreds of cases of human poisoning and nearly a hundred deaths in recent decades (Mee *et al.* 1989, Rosales-Loessner 1989, IOC 2008). Ciguatera, caused by the consumption of some species of tropical fish that feed in coral reef areas, is undoubtedly the main source of human poisoning associated with seafood in the region. Ciguatera is endemic in the Caribbean, where it constitutes a serious threat to public health, local fisheries and tourism (Tester *et al.* 2009). Every year, several hundred cases are reported, but many others go undetected because doctors and the general population lack the knowledge to identify its symptoms. Furthermore, although it is seldom mortal, ciguatera is a recurring syndrome in affected patients, causing gastrointestinal and neurotoxic problems that generate negative economic impacts owing to the considerable number of lost workdays (see Tosteson in IOC 1998).

Not every country has an established programme to monitor potentially toxic microalgae and phycotoxins in order to ensure seafood safety and to protect public health. Frequently, the authorities' sporadic support and specialists' efforts to carry out sampling of phytoplankton and biotoxins come too late, when a suspicious plankton bloom or a toxic outbreak has already occurred. On more than one occasion, ignorance of the organisms causing the toxic event has triggered social

alarm and stopped seafood consumption on account of the mere appearance of a plankton patch (later found to be totally innocuous) and the scaremongering tone of the media. Such was the case when a red tide ( $> 2 \cdot 10^6$  cell  $\cdot$  L<sup>-1</sup>) of the dinoflagellate *Gonyaulax cf polygramma* formed in the Bay of Cartagena, Colombia, in May 2010 (Fig. 3) (country report from Colombia, 2010). In other countries, monitoring programmes are limited to health controls on molluscs and fish for export because a lack of such standards would hamper the entry of these products into the United States, the European Union and other markets. Meanwhile, local people who harvest bivalves and fish for their family's consumption are exposed to high risks to their health when they eat unmonitored seafood.

### References

- IOC (1995) FANSA II: Second IOC Regional Science Planning Workshop on Harmful Algal Blooms in South America, Mar del Plata, Argentina 30 October - 1 November 1995. IOC Workshop Report No. 123, UNESCO, Paris (Spanish) IOC link: [http://hab.ioc-unesco.org/index.php?option=com\\_oe&task=viewDocumentRecord&docID=2847](http://hab.ioc-unesco.org/index.php?option=com_oe&task=viewDocumentRecord&docID=2847)
- IOC (1998) First meeting of the IOC Working Group on Harmful Algae in the Caribbean and adjacent regions (IOCARIBE-ANCA). IOC WS Report 150 (English and Spanish) IOC link: [http://hab.ioc-unesco.org/index.php?option=com\\_oe&task=viewDocumentRecord&docID=8641](http://hab.ioc-unesco.org/index.php?option=com_oe&task=viewDocumentRecord&docID=8641)
- IOC (2008) Regional Review of Harmful Algal Events in the Caribbean. IOC Regional Science Planning Workshop on Harmful Algal Blooms in IOCARIBE- ANCA IV, 22-27 May 2007, San Andres, Colombia (Spanish) IOC link: [http://hab.ioc-unesco.org/index.php?option=com\\_oe&task=viewDocumentRecord&docID=2852](http://hab.ioc-unesco.org/index.php?option=com_oe&task=viewDocumentRecord&docID=2852)
- Mee LD, Espinosa M, Díaz G (1986). Paralytic shellfish poisoning with a *Gymnodinium catenatum* red tide on the Pacific coast of México. *Mar. Environ. Res.* 19: 17-92.
- Rosales-Loessener F, Porras E de, Dix MW (1989) Toxic shellfish poisoning in Guatemala. In: Okaichi T, Anderson DM, Nemoto T (eds), *Red Tides: Biology, Environmental Science and Toxicology*. Elsevier, Amsterdam, pp 113-116.
- Tester PA, Feldman RL, Nau AW, Faust MA, Litaker RW (2009) Ciguatera Fish Poisoning in the Caribbean. *Smith. Contrib. Mar. Sci.* 38: 301-311.

## 2 Designing a plan to monitor potentially toxic microalgae: General guidelines and methods

Silvia Méndez<sup>1</sup>, Rosalba Alonso<sup>2</sup>, Angel Moreira<sup>3</sup> and Beatriz Reguera<sup>4</sup>

<sup>1</sup>Dirección Nacional de Recursos Acuáticos, Constituyente 1497, 11200 Montevideo, Uruguay (smendez@dinara.gub.uy)

<sup>2</sup>Universidad Nacional Autónoma de México, Unidad Académica Mazatlán, Av. Joel Montes Camarena s/n, Col. Playa Sur, Mazatlán, 82040 Sinaloa, México (rosalba@ola.icmyl.unam.mx)

<sup>3</sup>Centro de Estudios Ambientales de Cienfuegos, Apartado Postal 5, Ciudad Nuclear, 59350 Cienfuegos, Cuba (angelmorairagonzalez@gmail.com)

<sup>4</sup>Instituto Español de Oceanografía, Subida a Radio Faro 50, 36390 Vigo, Spain (beatriz.reguera@vi.ieo.es)

### Introduction

Under the IAEA-TC projects, a main objective of monitoring is to provide an early warning of potentially toxic microalgal blooms, whose toxins are transmitted through the food chain and affect public health. To minimize the negative impact of this type of event, two monitoring strategies can be applied:

- a) Monitoring the presence of potentially toxic species
- b) Monitoring the presence of toxins in commercialized resources

The design of a monitoring programme must be partially based on knowledge of the hydrography and ecology of phytoplankton in the coastal area to be monitored. If no previous information is available, the only choice is to begin extensive monitoring which covers the majority of the area under study and which will be adjusted as the needed information is generated.

It is essential to design the monitoring programme in a way that ensures:

- The early detection of potentially toxic species and their toxins in marine products, with the goal of protecting public health and implementing management strategies
- It is cost-effective, i.e. a programme with a good cost-benefit ratio for the resources to be protected

Given that the list of harmful species should always be open to the inclusion of new toxic species, the ideal programme would be one that identifies the composition of the whole phytoplankton community throughout the year, in areas of commercial and/or recreational importance. Since such a programme would require an enormous human effort, careful monitoring of the list of potentially toxic species for specific regions is needed. The list must be periodically updated on the basis of a bibliographical review and national reports by specialists from different countries, and complemented with existing information gathered by regional groups, such as the Working Group on Harmful Algae in the Caribbean and Adjacent Regions (IOCARIBE-ANCA). At the same time, it should take into account the IOC-UNESCO Taxonomic Reference List of Harmful Microalgae compiled by the Task Team on Phytoplankton Taxonomy (Moestrup *et al.* 2009).

### Choosing the sampling sites

The selection of primary stations —permanent sampling sites that are deemed the most representative— should take into account the following factors:

- Records of past toxic events, which give an idea of the “hotspots” or risk areas where cases have already been reported in the past
- Movements of water masses: known physical mechanisms carrying water from a source (e.g. tide, estuary, upwelling) away from the coast, or coastal currents
- Location of fronts, i.e. boundaries between two different water masses

If there are known transport mechanisms, the sampling stations should be established “against the current”, in a direction going away from areas of interest, such as natural beds and fish farms, towards fronts and currents. For example, in a fjord, estuary or bay, the detection of problematic species at an external station located in the mouth (widest part) of the system, connected to the open sea, allows for early warnings about what is approaching interior areas where fish farms and natural beds are found.

Shelf fronts —zones where stratified outer waters meet mixed interior waters— provide optimal conditions for the development and/or physical accumulation of dinoflagellates (Carreto *et al.*, 1986) and are therefore areas of high productivity. Such fronts in the open sea can act as sources of harmful algae that will be transported under favourable meteorological conditions to farming areas. In areas of positive estuarial circulation, the presence of saline fronts is normal. They are formed where brackish waters flowing out along the surface meet the more saline outer waters from the adjacent shelf. The detection of harmful species in fronts means that an early warning can be given about populations that might later reach areas that are sensitive from a socioeconomic point of view. A good example of an estuarial front is the one originating in the Río de la Plata, part of the southern border of Uruguay, which discharges fresh water from five countries out of a drainage basin of 3,200,000 km<sup>2</sup>. Near Uruguay lies the Subtropical Convergence, a major thermohaline front between tropical and sub-Antarctic waters. The seasonal patterns of the main species that produce paralytic shellfish toxins (PST) in Uruguay are closely linked to the dynamics of this front (Méndez and Galli 2008).

Other examples of a “vertical front” are thermoclines, or areas of strong thermal gradient that are formed during months of greater sunshine, and haloclines, or areas of maximal salinity

gradient, which are particularly relevant after heavy rainfall. The vertical distribution of these density gradients is critically important for determining the sampling depths for each station because they are optimal zones for the growth and/or accumulation of dinoflagellates and pennate diatoms.

## Sampling frequency

In monitoring programmes designed to protect public health and seafood safety, an adequate sampling frequency is a crucial factor. Rapid changes in wind direction and velocity may lead to advection of open coast populations of toxic microalgae in to coastal lagoons and embayments on the same time scale. In this scenario, filter-feeding shellfish may accumulate toxins above regulatory levels in as little as 2-3 days. Fisheries and health authorities will have to implement shellfish harvesting closures. In a few more days (7-10 days), toxins in shellfish may reach dangerous levels and cause human intoxications. A weekly sampling frequency for potentially toxic phytoplankton at representative stations and for toxins in shellfish is required for adequate protection of public health and seafood markets.

There are also biological processes, such as massive cyst germination, which may lead to dramatic changes in toxic microalgae densities within similar time scales.

Last but not least, a good knowledge of the microscale variability associated with tides, in particular in shallow bays with dynamic tidal regimes, will be essential to plan sampling hours accordingly.

In summary, a weekly sampling frequency for potentially toxic phytoplankton at representative stations and for toxins in shellfish is required for adequate protection of public health and seafood markets.

It is important to know where the fronts and the zones of discontinuity of the water column are located and how the water masses move in response to the local meteorology (e.g. winds and rainfall patterns). It is **essential to discuss the location of the sampling sites with specialists who know the local hydrodynamics.**

## Materials and methods for sampling phytoplankton and environmental conditions

### Materials and equipment

- Clipboard and template for noting down data
- Multiparameter probes, CTDs, or other available instruments for taking in situ data regarding salinity, temperature, pH, dissolved oxygen, chlorophyll, etc. (Fig. 1)
- Immersion thermometer with a scale of 0.1 °C (in case the probe does not work)
- Secchi disk with a weight and a cord marked every 1 m and if possible, a secondary mark every 50 cm (Fig. 2)
- Plankton net (20 µm) with a weight to ensure the descent and a rope with knots or tape marking every 1 m (to indicate the depth of vertical hauls) (Fig. 3)
- Water-sampling bottle (if this sampling method has been chosen instead of using a hose) with a cord and messengers (Fig. 4)
- Tube or hose-sampler with the necessary segments to cover the maximal length of the water column in the sampling sites (Figs. 5-6)
- A wide-mouthed plastic container (100–200 ml) with a screw cap for holding the haul
- Wash-bottle with filtered seawater
- Sieve (150 µm)
- Plastic containers in which to empty the samples from the hose
- Tinted or UV-resistant bottles, labelled, for water samples for quantitative plankton analysis
- Pipettes (or automatic dispensers) and fixatives (e.g. formalin, Lugol's iodine)
- Indelible pens or markers, and labels
- Container with thermal insulation for transporting the samples

### Method

1. Once located at the sampling site, check the coordinates using GPS and write down any discrepancies regarding the coordinates of the sampling site.
2. Note down the time, state of the tide and all possible meteorological information (e.g. winds, cloud coverage, rain in previous days).
3. Lower the Secchi disk and write down the depth (m) at which it is no longer visible.
4. Make a vertical net haul.
5. Open the stopcock/unscrew the cod end of the net, put the haul into the jug and:
  - a) If the haul is going to be observed a short time later (1–2 h), pour the haul into the container in which it will be transported and close the screw cap.
  - b) If it is going to be observed hours after the collection, filter the haul through a 150-µm sieve to remove zooplankton organisms that consume phytoplankton. Then dilute the haul with surface water to keep it in good condition.
  - c) If the haul is not going to be observed until the next day and/or it is difficult to keep cool, pour the haul into the screw-capped bottle in which it will be transported and fixed with formalin (final concentration of 4%).
6. Slowly cast the hose-sampler, with all the stopcocks open, until it reaches the surface mark. Close the stopcock at the upper end and pull up the hose slowly, closing the stopcock for each segment until the entire hose is on the deck of the boat.
7. Empty the contents of the hose (entirely or each segment, previously disconnected, at a time), opening the stopcock for each section and pouring the contents into a plastic container with the help of a funnel.
8. Move the container in gentle circles, take an aliquot (250–500 ml) into the labelled bottle (date, sampling station, type of sample) and fix it with Lugol's iodine (Fig. 7).

### Considerations:

- The steps for “basic” phytoplankton sampling, are described here. Some laboratories might have means to take samples to measure other parameters (e.g. nutrients, chlorophyll, dissolved oxygen) which are not explained here.

- The net hauls should be observed *in vivo* whenever possible since some unarmoured species are difficult to recognize in preserved samples. Observation of net hauls allows you to make a “qualitative” list of the species present. This aspect is very important because some potentially toxic species might be present in concentrations below the detection levels of quantitative methods. In this way, indications can be found to justify an early warning of dangerous species identified below the detection level of the quantitative methods used.
- A single integrated sample should be taken with a hose at each sampling station. Nonetheless, a section at the end of the chapter describes Lindahl’s divisible hose (1986), which has four segments, each measuring 5 m (Fig. 5). The hose with different segments is very easy to handle and provides information about conditions at the surface and bottom of the sea. In addition, those who are more interested in studying the ecology of HABs in their region and are able to do so, may empty the hose sections into separate containers and take samples from different depth-intervals (0–5 m, 5–10 m, 10–15 m and 15–20 m) of the water column.
- In the case of very shallow sampling stations (a few metres deep), water samples should be collected either with a Lund tube-sampler (Fig. 5) or with rigid PVC tubes (1–2 m) that have a check valve allowing water to enter but not to leave, or a rubber stopper at the upper end (Figs. 8-9). Alternatively, water-sampling bottles, or even a bucket can be used if the station is in an area with well-mixed water.

### Temperature and salinity: Multiparameter probes and CTDs

Temperature (T) and salinity (S) are important environmental parameters that affect the physiology of microalgae. Each species/strain has T and S ranges in which its development is optimal. In addition to the absolute values of T and S, it is very important to know the species’ vertical distribution. The thermohaline characteristics of the water determine its density, and the variation rate of density in relation to depth (i.e. density gradient) determines the static stability of the water column.

The maximum population, or peak, of many HAB species has reportedly occurred in association with a marked density gradient of water columns, as observed in:

- a) Thermoclines, or layers of water with a pronounced temperature gradient, which form during times of maximal sunshine
- b) Haloclines, or layers of water with a pronounced salinity gradient, which form after heavy rains, or in areas with inflows of fresh water, such as estuaries
- c) Pycnoclines, or layers of water with a pronounced density gradient. Nutriclines, or layers of water with a pronounced nutrient gradient usually coinciding with pycnoclines.

In upwelling zones, the nutricline is the transitional zone between the layer of surface water, warm and poor in nutrients,

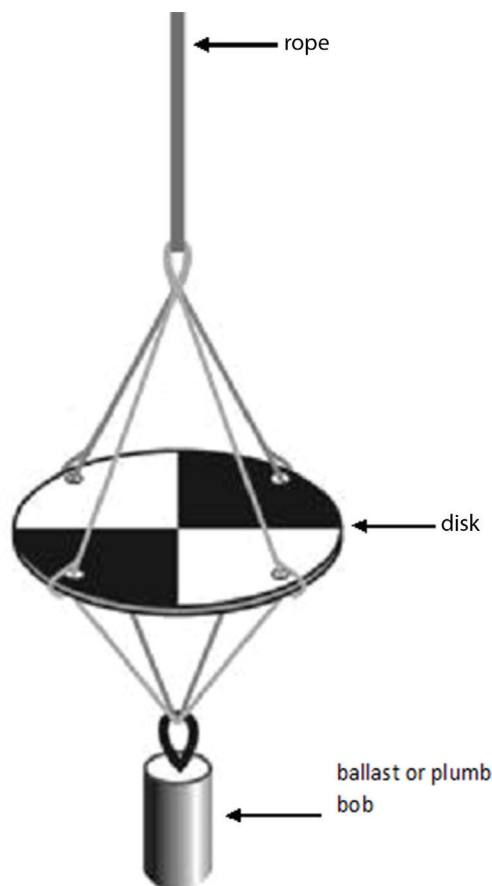

**Figure 1.** Left: using an immersion thermometer inserted directly into the water-sampling bottle. Centre: YSI multiparameter probe for measuring temperature and salinity. Right: CTD (conductivity, temperature, depth) multiparameter probe attached to the winch of the boat before being cast.

and the colder water, rich in nutrients, surging from the bottom. When sampling phytoplankton, it is important to take into account the typical vertical distribution of T and S in the area. Layers with high density gradients are major areas for the aggregation of microorganisms (through physical accumulation or because the layer has optimal conditions for growth) and for the formation of the chlorophyll maximum.

T and S data can be taken in the following ways (Fig. 1):

- The traditional method involves casting water-sampling bottles that have inversion thermometers. Water from the water-sampling bottles is put into glass bottles with screw caps to determine salinity (S) in the laboratory.
- An immersion thermometer (accuracy to 0.1 °C) and water-sampling bottle for taking samples to determine S in the laboratory.
- A multiparameter probe (e.g. YSI 6600-2) with a hydrographic line that is long enough to cover the desired depth and that has sensors for the variables considered in the study.
- A CTD, an instrument used to determine the conductivity, temperature and depth of the ocean, has greater accuracy than multiparameter probes for measuring data for oceanographic studies and can include sensors for other parameters (e.g. fluorescence *in vivo*, dissolved oxygen, pH, turbidity). This device requires proper calibrating. After casting it into the water, you must leave it, still and submerged, for at least one minute before lowering.



## Transparency: The Secchi disk

The Secchi disk is a simple instrument, which can be home-made, used to estimate light penetration, i.e. the transparency of water, which is inversely proportional to the turbidity of the water column. Turbidity, in turn, depends on the concentration of suspended particles such as phytoplankton, sediments from erosion or re-suspended from the sea bottom, effluent discharges of anthropogenic origin, and so forth. This suspended material causes light to be scattered and absorbed by coloured substances (e.g. pigments, dissolved humic substances).

The components of a Secchi disk (Fig.2) are:

- A circle of approximately 30 cm in diameter preferably made of polythene, which may or may not have a stainless steel reinforcement. It is white, or if increased contrast is desired, divided into quadrants painted alternately black and white.
- A cord or rope attached to the disk, which should be graduated (marks every 25 cm and larger marks every metre)
- A weight or plumb bob as ballast for the disk

To measure the **depth of vision**, known as **the Secchi depth**, lower the disk from the vessel, leeward and from the shady side in order to avoid reflections on the surface. The disk must be cast well so that rope attached to it achieves maximum per-



**Figure 2.** Various models and parts of a Secchi disk; view of a disk submerged in water with plenty of greenish pigments.

pendicularity in relation to the surface and so that the action of the currents is minimized.

Note down the depth at which the disk is no longer visible. To make a proper measurement, lightly let out and then pull up the disk until it reaches the depth where it can no longer be seen. For greater accuracy in measurement, repeat the operation and note down the average value of the two measurements.

Based on the previous measurements, the **compensation depth** can be estimated (approximately 2.7 times the Secchi depth), which is the depth at which the oxygen produced by photosynthesis is equal to that consumed by respiration. This is the water layer where the depth of light allows for photosynthesis; it is therefore a favourable layer for the growth of phytoplankton.

Measuring the **depth of vision, or Secchi depth (D)**, is highly useful for choosing the appropriate depths for taking phytoplankton samples for analysis. For example, in extremely clear ocean water, the photic layer and compensation depth (**approx. 2.7 x D**) are much deeper than in coastal waters with high turbidity. It is necessary to plan the depths for sample-taking accordingly.

## Plankton nets

Phytoplankton usually appears in moderate or low densities that make direct observation with an optical microscope difficult because the sample needs to be concentrated. Conical plankton nets are the most traditional method used to concentrate field samples (Fig. 3).

For routine sampling as part of a HAB monitoring programme, plankton nets with a mesh size of 10–20  $\mu\text{m}$  are used. A vertical haul is taken from the depths of the photic layer (estimated using the Secchi depth) up to the surface.

Once located at the sampling site, follow these steps:

- From the vessel, lower the plankton net with its cod end, weight (or plumb bob) and rope with length marks.
- Make sure that the net has not accumulated air pockets that hinder its vertical descent and make it float. If this is the case, “purge” the net by making water enter through the mouth and leave through the cod end. Then raise and lower it again.
- When the net reaches the desired depth, begin to raise it slowly and carefully (netting is a very delicate material that breaks easily).



**Figure 3.** Left: plankton net with a cod end with a stopcock for unloading the sample. Right: plankton net with a cod end, or collection cup, and a weight attached for the descent into the water (model provided to participants in Project RLA/7/014).

- Once the net has been retrieved, unscrew (or dismount) the cod end and pour the contents into the container in which they will be transported in vivo to the laboratory.
- If much time (several hours) will transpire between collection and observation, it is recommended to fix an aliquot of the sample with formalin (final concentration of 4%) because the species in the net haul will break down quickly, especially if they are very dense and the ambient temperature is high.

Samples obtained by net hauls are **inappropriate for quantitative analysis**, because the net is a selective method (it selects species that are larger than the mesh size and lets most of the smaller ones escape). Nevertheless, filtering a large amount of water with a simple vertical haul in an illuminated water layer can enable the **early detection** of scarce (e.g. *Dinophysis* spp.) and potentially toxic (e.g. *Alexandrium* spp.) species found in the initial phase of bloom development, at lower concentrations than the detection limit in the Utermöhl method (20–40 cells l<sup>-1</sup> if 25–50 ml sedimentation chambers are used).

It is highly advisable not to fix the net hauls so that they can be observed in vivo under a microscope as soon as they arrive at the laboratory, especially since some unarmoured species are much easier to identify in this way. The samples are kept in glass bottles in a portable container with thermal insulation. If the colour of the haul suggests a high concentration of plankton, dilute the sample with water from the same sampling station until it has a very light tone. In the case of bloom patches, you can sample directly with a container (no net) and dilute the sample with clearer water from another depth to keep the cells alive for observation at the laboratory. If a very high concentration of zooplankton organisms is observed, it

is a good idea to pour the sample through a 150-µm sieve to eliminate large filter-feeders (although the risk then increases of losing large dinoflagellates such as *Noctiluca* spp., or long chains of some *Alexandrium* spp. and *Gymnodinium* spp.).

The nets are rinsed after their use with fresh water using a hose. It may sometimes be necessary to wash the net (without the cod end or the support ring) with a small amount of neutral detergent (or in a washing machine on a cycle for delicate clothes or wool). If this step is not taken, the mesh netting will gradually become obstructed and will lose its filtering effectiveness. It is not recommended to use metal supports or rings, which shorten the life of the net owing to corrosion problems. It is sufficient to use PVC supports and, for fastening, strong lines of thick cotton or nylon. The cod end can be a PVC cylinder with a closed bottom, which will cause less friction for the cells than a cod end with a removable bottom. There are modern net designs whose cod end has a stopcock, which greatly facilitates sample collection.

### Water-sampling bottles

Sampling bottles are devices for obtaining samples of water at a specific depth of the water column. The bottle, which is a metal or plastic cylinder with two caps on either end, is attached to a cable. Its two caps are attached in such a way that they snap shut when the closing mechanism is pressed (Fig. 4).

Water-sampling bottles provide suitable water samples for **qualitative and quantitative analyses of phytoplankton at a determined depth of the water column**. If a sufficient number of bottles are cast at each sampling station, the vertical distribution of phytoplankton species of interest and the organisms accompanying them can be described.

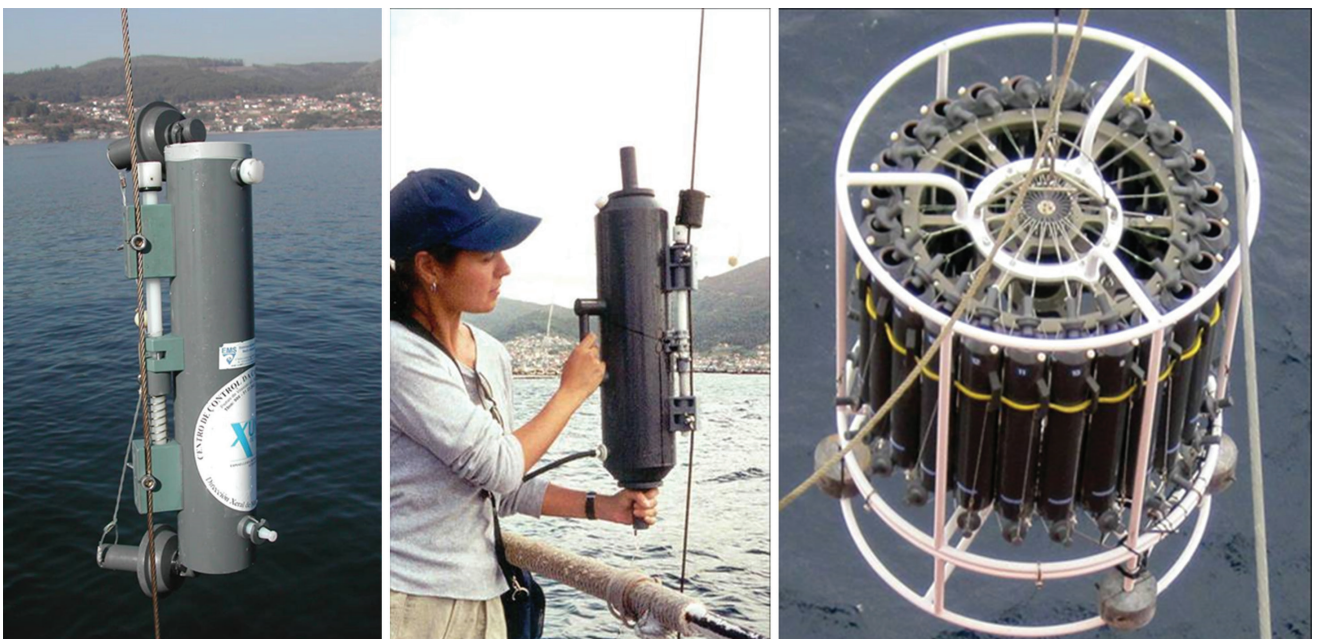

**Figure 4.** Left: water-sampling bottle ready for the descent, with its caps open. Centre: bottle retrieved after the messenger has been cast and raised. Right: rosette with 24 water-sampling bottles.



The steps to follow:

- Attach the bottle to the cable with its two caps in the “open” position.
- Lower the bottle into the water using the cable. When it reaches the required depth, drop the metal weight called “messenger” down the cable. When the messenger hits the closing mechanism, the two caps immediately shut and the bottle traps the water at that depth.
- Haul in the cable and retrieve the bottle. A series of bottles and messengers can be fixed to the cable at determined intervals so that samples of different depths are taken simultaneously in a single action.

The old Nansen bottles had pairs of inversion thermometers attached to them. When they were struck by the messenger, they would turn 180° and the mercury tube in the inversion thermometer would be trapped, fixing the temperature reading taken in situ. In this way, water and temperature were measured at a determined depth. The different readings between one thermometer, protected and therefore pressure-resistant, and the other, unprotected, allowed for pressure estimates. Currently, Niskin bottles are used, which do not turn over when hit, and temperature is measured by means of multiparameter probes (e.g. temperature and salinity sensors, CTDs). During oceanographic surveys, “rosettes” are used. These are circular devices that group together up to 24 Niskin bottles at the same time (Fig. 4).

## Tubes and hose-samplers

Phytoplankton, and dinoflagellates in particular because of their capacity to move vertically in a water column, can present a very heterogeneous vertical distribution. Some species may form “thin layers”, i.e. highly dense aggregations in very fine bands (from a few centimetres to a few metres) in the water column. Conventional sampling methods using water-sampling bottles might not detect such high densities if they are found at depths other than those set for the sampling. This situation represents a risk for monitoring programmes that must obtain quantitative results on the concentrations of potentially toxic species.

Adequate sampling of stratified waters involves taking samples at various depths (4–5 at least) with water-sampling bottles, which means exceedingly time-consuming analytical work. One way to overcome this difficulty is to sample with tubes or hoses, which provide an integrated sample of the water column. In this way, no sampling point is lost although no information about the vertical distribution of plankton will be available. However, hoses can be split into segments, each one representing a depth-interval of the water column.

Tube/hose samples are appropriate for quantitative and qualitative analyses of phytoplankton. They greatly reduce the analytical work and detect harmful species that are aggregated in thin layers of the water column, but information about the vertical distribution of the organisms is lost.

Information on preparing and using a hose that is dividable into segments is presented below (Lindahl 1986) (Figs. 6-7). Its use in programmes to monitor potentially toxic phytoplankton has been recommended since 1986 by the International Council for the Exploration of the Sea's Working



**Figure 5.** Lund's tube sampler with disk-shaped plumb bob that encircles the bottom end of the tube.

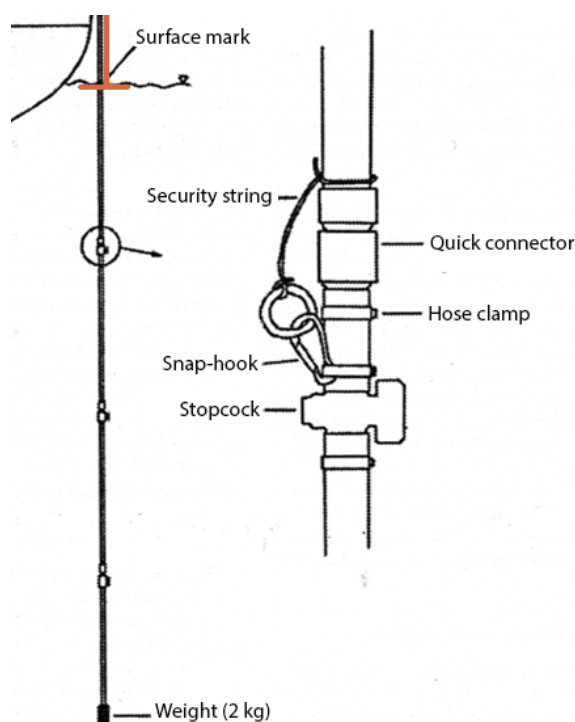

**Figure 6.** Hose-sampler dividable into segments for integrated samples of the water column (Lindahl 1986). Note the surface mark and the additional section of hose (marked in red), which must be added to the length (5m) of the first segment to cover the distance from the sea surface to the deck of the boat.

Group on Phytoplankton and Management of Their Effects. At shallow stations a dividable hose can be substituted with a single-section hose-sampler (Lund's sampler) (Fig. 5), or even a PVC tube with a stopper at the top end, which can sample a cylinder of the water column (Fig. 8). It is recommended to add a check valve at the lower end (Fig. 9).



**Figure 7.** Steps for using the dividable hose:

- a) Hold up the top end of the hose, rolled up on the deck of the vessel.
- b) Put all stopcocks in the “open” position.
- c) Gently lower the hose into the water.
- d) Close the top stopcock and hoist the hose full of water. Close the other stopcocks as they appear as the hose is being pulled up.
- e) Disconnect the different segments of the hose and pour the contents into plastic containers with the depth-interval marked (0-5, 5-10, 10-15 and 15-20 m).
- f) After opening the stopcock, empty one segment of the hose into the corresponding container.
- g) Take an aliquot, for quantitative phytoplankton analysis or other analyses, and put into a properly labelled bottle (e.g. date, sampling station, depth range).



**Figure 8.** Sampling tube (> 2 m) with a check valve at the bottom end, used by INVEMAR, Colombia.

### Preparing and using the hose-sampler (Fig. 7)

#### Materials and methods

- **A rubber garden hose** with an inner diameter of 12–25 mm (plastic hoses are less recommended because they get stiff when it is cold). Important: on top of the desired sampling depth must be added the distance between the water surface (show the “surface mark” with duct tape) to the working area on the deck of the vessel. **It is not recommended to use hoses longer than 20 m.** The length (m) and number of segments can vary.
- **Quick connectors**, like those used in gardening. It is recommended to add snap-hooks and strings so that to attach adjacent sections of hose in case the connector malfunctions.
- **Stopcocks** (i.e. valves) made of polypropylene, allow the water entry to be opened or closed with a simple turn of 45°.
- **A weight or plumb bob** (2 kg), which go around the bottom end of the hose so that it does not interfere with the flow of entering water (Fig. 5).
- **Plastic containers**, on which is marked in indelible ink the depth-interval of the sample to be poured into it.



**Figure 9.** Close-up of a check valve used with a tube measuring two inches in diameter (Photo: INVEMAR, Colombia).

#### Procedure to collect the hose samples

**Step 1:** Slowly lower the hose, making sure that it is not folded anywhere, at a maximal speed of 20 m per minute<sup>-1</sup>, with all stopcocks open, until it reaches the surface mark.

**Step 2:** Once the surface mark touches the water, close the upper stopcock. In this way, all the water contained in the hose is held inside through capillary action.

**Step 3:** Begin to pull up the hose and close the stopcocks as they appear.

**Step 4:** Once the hose is on the vessel deck, separate the connectors and empty each segment into a properly labelled plastic jug or other container. The stopcock end should be kept higher than the other end to facilitate emptying. The container for collecting the water should be wide so that the sample can be agitated before the aliquots are taken, thus ensuring a representative sample from the depth interval sampled.

**Step 5:** Take aliquots of water into properly labelled bottles and immediately fix the sample with a solution of Lugol's iodine (0.5 ml/100ml). The colour of the fixed sample should resemble that of whisky.

**Table 1.** Recipes for Lugol's iodine solution (acidic, alkaline and neutral) (Andersen & Throndsen, 2004).

Acid	Alkaline	Neutral
20 g potassium iodide (KI)	20 g potassium iodide (KI)	20 g potassium iodide (KI)
10 g iodine (I <sub>2</sub> )	10 g iodine (I <sub>2</sub> )	10 g iodine (I <sub>2</sub> )
20 g concentrated acetic acid	50 g sodium acetate	200 mL distilled water
200 mL distilled water	200 mL distilled water	

**Table 2.** Recipes for preparing neutral formaldehyde. In both cases, filter the preparation after a week in order to remove precipitates.

Neutral formaldehyde (Throndsen 1978)	Neutral formaldehyde (Andersen & Throndsen 2004)
500 mL formaldehyde 40%	500 mL formaldehyde 40%
500 mL distilled water	500 mL distilled water
100 g hexamethylenetetramine (C <sub>6</sub> H <sub>12</sub> N <sub>4</sub> ) pH 7.3 – 7.9	Neutralize with a sodium borate solution (Na <sub>2</sub> B <sub>4</sub> O <sub>7</sub> ·10H <sub>2</sub> O) saturated pH 7-7.5

### Fixatives and preserving agents for plankton samples

First of all, it is important to clarify that not one fixative or preserving agent is universally suitable for all types of microalgae; each must therefore be chosen depending on the aim of the study (or aliquots of one sample can be preserved with different fixatives so as to serve for various purposes).

The fixing and preserving agent most used is a potassium iodide solution known as Lugol's solution or Lugol's iodine (acidic, neutral or alkaline) (Table 1). If the samples will be stored for long periods of time, they must be preserved with neutral formaldehyde (Table 2).

Lugol's solution is used for short periods of storage (e.g. a few months). It does not destroy athecate dinoflagellates, but it does destroy coccolithophorids when the solution is acidic. Lugol's iodine is the most recommended preserving agent for the counting of phytoplankton and benthic microalgae because it does not have the drawbacks in terms of hygiene and work safety that formalin does.

Lugol's iodine degrades through photo-oxidation, which is why samples must be stored in the dark, in tinted bottles. In addition, the sample must be verified regularly for colour loss, and more reactant added if necessary. Alternatively, there are (more expensive) glass bottles, impermeable to UV rays, which allow samples fixed with Lugol's iodine to be kept for long periods of time without colour loss. To count the majority of microalgae (except coccolithophorids) it is recommended to use the acidic solution of Lugol's iodine. Nonetheless, if DNA amplifications (PCR) of the cells are going to be carried out, the use of neutral Lugol's iodine is recommended.

The recommended concentration is between 0.2 ml and 0.5 ml of Lugol's solution for every 100 ml of final sample volume. The final colour should resemble whisky. It may be necessary to add more solution to samples with a higher plankton content.

Formaldehyde (formalin, methanol or formic acid – HCOH) is an acidic fixing and preserving agent (pH 3–4.5). It is aggressive for athecate, or naked, dinoflagellates: it distorts the cell shape, flagella are lost, and the cell disintegrates in some cases.

Formaldehyde is toxic when inhaled, a moderate irritant in case of direct contact with skin, a severe irritant to the eyes and a carcinogen in cases of chronic exposure. The use of this preservative must occur in a ventilated area (in some countries, it is mandatory to install fume extractors above every microscope under which someone is working with samples fixed with formalin). You should wear gloves when handling it and avoid exposure to its vapour. Sample sedimentation (for the Utermöhl method) is preferably done in a fume cupboard.

The concentration of commercial formalin is 37%–40%, which must be taken into account when calculating the quantity to add for fixation. If the final concentration in the fixed sample is going to be 4%, this means diluting ten times the commercial solution of 40% or, in other words, adding one part of formalin for every nine parts of sample. Neutralized formalin is the most suitable solution for preventing plankton samples from deteriorating.

For samples that are not very concentrated, adding 2–5 ml of the neutral formaldehyde solution for every 100 ml of final sample volume is sufficient.

### References

- Andersen P, Throndsen J (2004) Estimating cell numbers. In Halle-graef GM, Anderson DM, Cembella AD (eds) Manual on Harmful Marine Microalgae. Monogr Oceanogr Method 11, UNESCO, Paris, pp 99-129.
- Boltovskoy A (1990) Muestreador de agua tubular con válvula de cierre autónomo. Rev. Hydrobiol. Trop. 23: 171-173.
- Karlson B, Cusack C, Bresnan E (eds) (2010) Microscopic and molecular methods for quantitative phytoplankton analysis. IOC Manuals and Guides 55, UNESCO, Paris, 110 pp. (English only)
- Lindahl O (1986) A dividable hose for phytoplankton sampling. In: Report of the Working Group on phytoplankton and management of their effects. International Council for the Exploration of the Sea, C.M. 1986/L:26, Annex 3
- Sutherland TF, Leonard C, Taylor FJR (1992) A segmented pipe sampler for integrated profiling of the upper water column. J Plankton Res 14: 915-923.
- Throndsen J (1978) Preservation and storage. In: Sournia A (ed) Phytoplankton manual. Monogr. Oceanogr. Method 6, UNESCO, Paris, pp 69-74.

### 3 Methods for sampling benthic microalgae

Angel Moreira<sup>1</sup> and Patricia A. Tester<sup>2</sup>

<sup>1</sup>Centro de Estudios Ambientales de Cienfuegos, Apartado Postal 5, Ciudad Nuclear, 59350 Cienfuegos, Cuba.

<sup>2</sup>Ocean Tester LLC, 381 Gillikin Road, Beaufort, North Carolina 28516 USA

#### Introduction

Ciguatera fish poisoning (CFP) is endemic to the tropics and subtropics and is caused by eating fish that have bioaccumulated toxins, ciguatoxins (CTX) and maitotoxins (MTX), from epibenthic dinoflagellates in the genera *Gambierdiscus* and *Fukuyoa*. Toxins are initially accumulated in herbivorous fish that feed on macroalgae and coral rubble, common substrates for epibenthic dinoflagellates. Through processes of bioaccumulation, the toxins are transmitted through the food chain from herbivorous fish to carnivorous ones. CFP can cause gastrointestinal, neurological and cardiovascular disorders in patients, and in extreme cases respiratory failure leading to death. Furthermore, CFP is a recurring syndrome so victims become sensitized and suffer symptoms for weeks to months after initial exposure to CTX. While CFP is a natural phenomenon, it was considered a rare disease centuries ago, but today outbreaks have reached epidemic proportions in various geographic regions, mainly in the tropical Pacific and to a lesser extent in the eastern Caribbean. There is evidence that deterioration of coral reefs by human activity and hurricanes provides new substrate (surfaces) for opportunistic settlement of epibenthic microalgae including the toxic species.

The description of the type species of the genus, *Gambierdiscus toxicus*, by Adachi and Fukuyo (1979), from the Gambier Islands (French Polynesia) aided the discovery of the origin of CTX and the cause of CFP. The genus was believed to be monospecific until 1995 when Faust (1995) added a new species from the Caribbean. In 1998, Holmes (1998) described *G. yasumotoi* from Singapore. Quickly three new species from French Polynesia were described by Chinain *et al.* (1999), *G. australes*, *G. pacificus* and *G. polynesiensis*. Working with both Chinain and Faust, Litaker *et al.* (2009) described four new *Gambierdiscus* species and revised the genus, added molecular sequence data to the literature for all described species and helped provide the foundation for a resurgence of interest and research for this group. Currently, there are 12 described *Gambierdiscus* species, including two new ones from the Canary Islands (Fraga *et al.* 2011; Fraga and Rodríguez 2014), one from Japan (Nishumura *et al.* 2014) and *G. balechii* from the Celebes Sea in the SW Pacific (Fraga *et al.* 2016). The two 'globular' *Gambierdiscus* species (*G. yasumotoi* and *G. ruetzleri*) were moved to a new genus, *Fukuyoa* (Gómez *et al.* 2015) and a third species described in this genus. Subtle morphological differences distinguish the different *Gambierdiscus* species, some of which are toxin producers and some of which are not. Careful species identification is important and fortunately, an increasing number of molecular PCR (polymerase chain reaction) and qPCR (quantitative PCR) assays are being developed to assist in identification and confirm morphological identifications (Vandersea *et al.* 2012, Chinain *et al.* in preparation, Nishumura *et al.* 2016).

Other species of epibenthic dinoflagellates produce toxins and cause human illnesses. Okadaic acid produced by the genus *Prorocentrum* is the cause of diarrhetic shellfish poisoning), the ovatoxins and palytoxins from *Ostreopsis* and *Coolia* are credited with respiratory irritation from sea spray, and *Amphidinium* spp. are known to produce hemolytic substances. A complex mixture of toxins causing various syndromes have previously been included in the common term of CFP but improved methods and instrument sensitivity is helping to identify specific compounds and provide information on their modes of action.

This sampling protocol establishes a methodology for collecting and counting epibenthic dinoflagellates that cause ciguatera fish poisoning or other toxic syndromes (Yasumoto *et al.* 1977, Quod *et al.* 1995 Hallegraeff *et al.* 2003, Laurent *et al.* 2005). In addition a new method that uses artificial substrate will also be described (Tester *et al.* 2014). It has the advantage of providing quantitative samples that can be compared within and across studies. Both methods are relatively simple, inexpensive and basically consist of three stages:

1. Collecting the sample substrate (macroalgae) with attached benthic dinoflagellates. For the artificial substrate method, the substrate is deployed for 24 hours and retrieved in a similar manner as the macroalgae.
2. Separating the dinoflagellates from the substrate and sample fixation. Both the macrophyte and artificial substrate methods use similar techniques.
3. Counting benthic dinoflagellates and estimating cell abundance. This is standard for both the macrophyte and artificial substrate methods of collection.

#### Collecting the substrate sample (macroalgae)

##### Equipment

- Boots.
- Gloves.
- Lifejacket (for sampling from a boat).
- Snorkeling equipment for collecting in shallow areas. Scuba diving equipment (SCUBA) for collections deeper than 6-8 m (Fig. 1).
- Plastic bags for collecting the sample substrate.
- Permanent marker to label the bags.
- Plastic screw cap bottles for water samples.
- Multiparameter probe with sensors for temperature, pH, salinity, dissolved oxygen and chlorophyll a.
- Global Positioning System (GPS) for recording collection sites.
- Vessel with appropriate safety equipment (for collections in waters far from the coast).



**Figure 1.** Some of the basic equipment for collecting substrate samples (macroalgae). Top: Scuba equipment; bottom: light snorkelling equipment, plastic bags and indelible marker.

**Choosing the sampling stations (site selection)**

The selection of the sampling sites should be dictated by the substrates that are representative of the benthic communities, such as reefs, seagrasses, macroalgae communities, mangroves, etc., depending on the characteristics of the area under study (Fig. 2). The location of the site should be recorded with a GPS. To determine the collection site, it is important to take into account the epidemiological information on ciguatera in the local communities.

**Sampling frequency and choosing the substrate sample**

For many projects monthly sampling achieves an acceptable level of information. Nonetheless, greater frequency is desirable for studies on system dynamics. Most studies have shown that calcareous, fleshy, articulated macroalgae are the best substrate because they are associated with the benthic, CFP-causing dinoflagellates. Red seaweeds (Rhodophyceae) of the genera *Jania* and *Amphiroa*, brown macroalgae (Phaeophyceae) *Turbinaria* and articulated calcareous green (Chlorophyceae) algae, such as *Halimeda*, are good choices for substrate because they tend to host many benthic dinoflagellates, are very common in coral reef zones and leave fewer residues than other macroalgae when they are detached (Fig. 3). Other abundant macroalgae in reef areas are red algae of the genus *Dichotomaria* and brown algae of the genera *Sargassum* and *Dictyota* (Littler and Littler, 2000).



Macroalgal communities in an intertidal zone

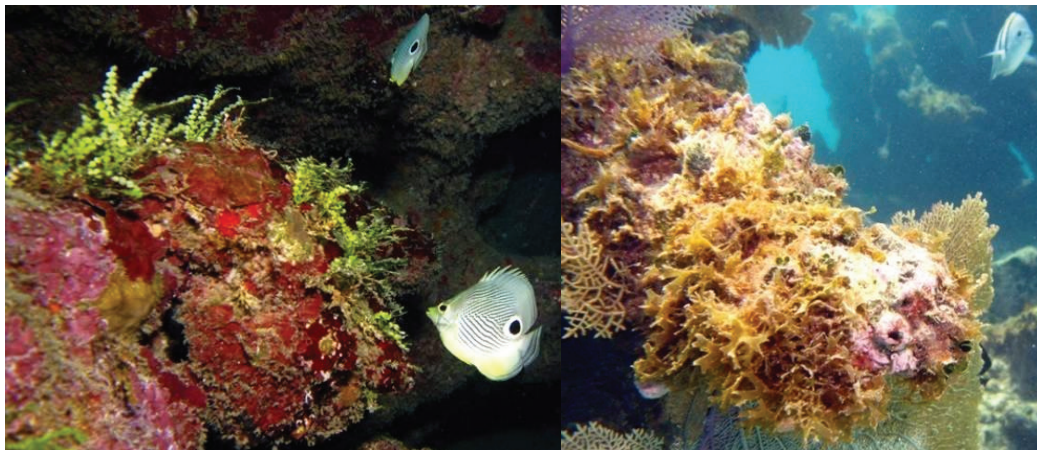

Macroalgal communities in coral reef zones

**Figure 2.** Biotopes suitable as sampling sites.

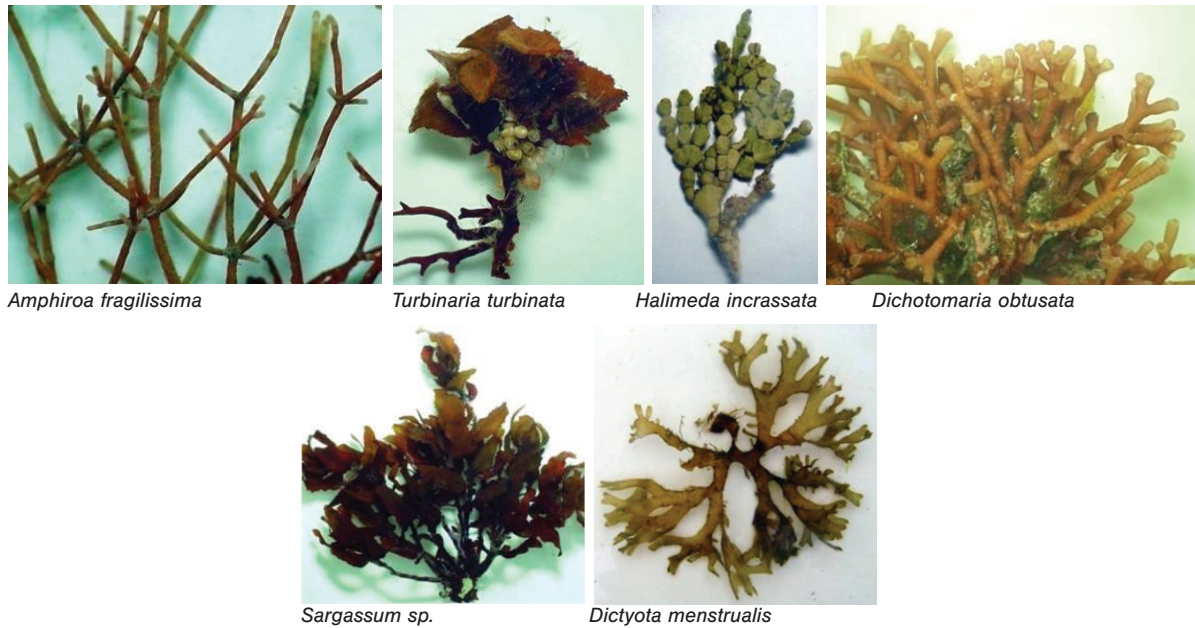

Figure 3. Macroalgae that are suitable as substrate samples.

### Sampling

When possible it is important to select the same species of macroalgae at all sampling stations, allowing comparisons within the study. It is recommended that leafy and green, filamentous macroalgae (*Ulva*, *Cladophora*, *Chaetomorpha*) not be used as substrate because they have ephemeral life cycles. In the absence of macroalgae, choose other substrates such as dead corals, seagrass, mangrove detritus and sediment surface. Collections can be made in intertidal zones (below the tidal zone) (Fig. 4) or in deeper reef areas. This may require the use of snorkeling or diving equipment (SCUBA). For each site collection (one in 10 m length) of two replicates of each sample should be taken. For each sample, manually collect about 250 g of macroalgae. If there are preliminary data evidencing a high abundance of dinoflagellates, the weight of the macroalgae sample may be smaller (50-100 g), which will prevent excess debris in the collected material. The macroalgae substrate should be surrounded with a bag so as not to lose any material. Make certain the bag is properly labeled (date, collection site, season) with a permanent marker. Seal the bag with the sample and seawater, place it out of the sun until further processing. Supplementary data are important and it is suggested that a water sample should be taken for pigment and water chemistry analysis and the following environmental factors be recorded at each site:

- Appearance of water (presence of cream, foam, algae accumulations).
- Temperature, salinity, turbidity, pH, dissolved oxygen.
- Macronutrients and chlorophyll a.
- Sample of macroalgal substrate for identification. Fix with formalin (4% final concentration).

Note that commercial formalin solution is to 40%. Therefore, a final concentration of 4% is achieved mixing one part commercial formalin solution and 9 parts of the sample.

### Detachment and preservation

#### Equipment and reagents (Fig. 5)

- Sieves of 250  $\mu\text{m}$ , 150  $\mu\text{m}$  and 20  $\mu\text{m}$  mesh size
- Filtered seawater
- Plastic wash bottle (squeeze bottle)
- Measuring cylinder (100 ml)
- Glass vials (50-100 ml) with plastic screw caps
- Pipettes of 5 or 10 ml
- Portable battery operated scale
- Formaldehyde
- Neutral Lugol's solution (see Table 1 in chapter 2))

Formalin fixation will destroy any opportunity to use the material for PCR assays. Neutral iodine fixation (1 drop per 15



Figure 4. Collecting macroalgae in an intertidal zone.



**Figure 5.** Some of the necessary equipment and reagents.



**Figure 6.** Processing macroalgae samples.



ml sample) for short periods generally renders the cell DNA viable for molecular identification methods (Vandersea *et al.* 2012).

#### Detaching process (Fig. 6)

- Vigorously shake the bag for two minutes to detach the dinoflagellates associated with the macroalgae. Take out the macroalga and weigh it after removing excess water with absorbent paper towel. Record weight.
- Pour the contents of the bag into a volumetric cylinder and record total volume.
- Filter seawater in the volumetric cylinder through three nested sieves: 250  $\mu\text{m}$  (top), 150  $\mu\text{m}$  and 20  $\mu\text{m}$  (bottom). If you do not filter all the seawater in this sample, note how much was filtered and record the volume. Also, place 50-100 ml of the unfiltered seawater in a container, record the volume and fix this sample if it is deemed important to have residual material from each sample site.
- Wash the 20  $\mu\text{m}$  sieve with filtered seawater using a squeeze bottle and recover the residue in the last sieve (150-20  $\mu\text{m}$  fraction). Bring the sample to a volume of about 50 ml. Pour into a test tube and record the final volume. Add the neutral solution of Lugol's (until you obtain a cognac colour) to preserve the sample.
- Material in the 250  $\mu\text{m}$  or 150  $\mu\text{m}$  sieves can be retained and preserved if it is required by the project's design. This is part of the total sample and if the material you are interested in is larger than 150  $\mu\text{m}$ , it is imperative to keep the contents from the middle sieve.
- For long-term storage, formalin (4% final concentration) should be added to the samples fixed with iodine.

The neutral 4% formaldehyde (final concentration) fixative is aggressive for some cellular structures and destroys some naked benthic dinoflagellates (e.g. *Amphidinium*). Nonetheless, it is suitable for permanent preservation of the sample thecate dinoflagellates. Given the toxic nature of this substance, precautions must be taken such as working in a well-ventilated area, wearing gloves and closing containers tightly. Before microscope observation of the sample, wash it with distilled water to remove excess formalin and resuspend in filtered seawater equal to the final volume of the original sample. Neutral iodine solution is used for short retention periods of a few months. Iodine preserved samples should be kept refrigerated and in dark containers. For fragile dinoflagellates like *Amphidinium* it is advisable to use an iodine fixative to preserve the cells. However, remember iodine is labile and it may be necessary to add a drop of formalin, after the initial iodine fixation, to prevent growth bacteria.

#### Artificial substrate method for collecting benthic dinoflagellates

Despite its simplicity and widespread use, the macrophyte method has some substantial disadvantages, especially for quantitative studies with benthic harmful microalgal cell abundance and/or distribution. Macrophytes may not occur in the study site(s) of interest or may not be present in quantities to allow replicate sampling. This is particularly troublesome for inter-comparisons among sites or for temporal sampling at the same site (Tester *et al.* 2014). The use of artificial substrates eliminates dinoflagellate-independent factors such

as grazing of macrophytes by herbivores, seasonal changes in macrophyte abundance and sediment type.

Other widely recognized challenges with the macrophyte sampling method concerns normalization of cell abundances to a unit allowing comparisons among substrates. Macroalgae are complex (Boller and Carrington 2006, Yñiguez *et al.* 2010). In the standard macrophyte method, microalgal cell abundance is normalized to macrophyte mass (cells  $\text{g}^{-1}$ ). Comparisons of cell abundance among different morphotypes, genera or macrophyte species is problematic because surface area:mass ratios vary greatly. The need for standardizing cell abundance to algal surface area (cells  $\text{cm}^{-2}$ ) rather than mass has long been recognized as the most logical solution to these problems (Bomber 1985, Lobel *et al.* 1988), but the methods for doing so are often complicated. The artificial substrate method offers many advantages for within and across study comparisons, spatial-temporal investigations and more robust hypothesis testing. The artificial substrates can be placed anywhere the experimental design requires without the need for macrophytes of the sample species to be available during all seasons. In addition the material retrieved from artificial substrates after a 24 h period is clean and free of diatoms and detritus, making it less difficult to count the cells or do single cell isolations for starting cultures (Jauzein *et al.* 2016, Tester *et al.* 2014).

#### Assembly of artificial substrate sampling device (Fig. 7)

- Cut pieces of fiberglass window screen that fit into the collection jar without folding or bending. Pieces of window screen 10.2  $\times$  15.2 cm square screen will fit into a 750 ml straight sided, wide mouth sampling jar with little manipulation. Fiberglass screen can be sourced from New York

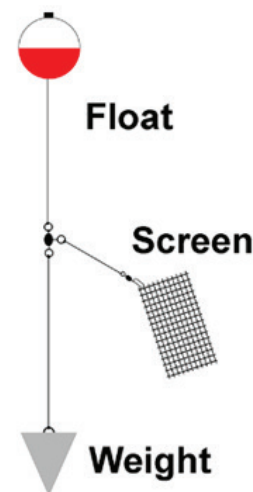

**Figure 7.** Artificial substrate sampling device. The length of the line to the screen is short enough to hold the screen 10-15 cm above the substrate. Float is at the subsurface (well below the surface of the water column) to avoid undue movement and detection. The screen is attached to the line using a barrel or snap swivel. These can be sourced at fishing tackle shops or online at <http://www.tackledirect.com/rosbarswiv.html> or <http://www.berkley-fishing.com/products/terminal-tackle/snaps-swivels>. A common safety pin may be used to connect the screen to the line if swivels are not available.

Wire part number FCS8678-M (Available from Amazon <http://www.amazon.com/New-York-Wire-FCS8678M-Fiberglass/dp/B000LNM0YK>).

- Floats can be made with any material, but should be sub-surface to limit tampering, vandalism or theft. Empty capped water bottles or fishing floats may be used.
- For the anchor, use whatever is convenient (large conch shells, bricks, lead weights, etc.)
- The float, screen and anchor are connected using monofilament fishing line.
- The bottom of the suspended screen floats freely about 10 cm from the surface of the sediment.

### Collection and preservation of quantitative artificial substrate samples

This protocol is intended for 10 x 15 cm pieces of black fiberglass window screen. Cell abundances (cells 100 cm<sup>-2</sup>) are normalized to the surface area of the screen material.

#### Materials

- 10 x 15 cm pieces of fiberglass window screen (Fig. 8)
- 100-300 µm pore size mesh sieve funnel (large enough to fit the sieve)
- Screen mooring supplies (line with float, weight, and snap connector)
- 1 l graduated cylinders
- 100 ml graduated cylinder
- Sample data sheet – see Excel file attached
- Paraffin tape
- Neutral Lugol's Iodine Solution
- 25 mm filter funnel, base and stopper
- 20 µm nylon mesh pieces cut to fit a 25 mm filter base
- Side-arm flask (500 or 1000 ml)
- Filter funnel to fit 25 mm filter base
- Hand vacuum pump and tubing
- Forceps
- Transparent wide mouth sample jars (500 – 800 ml)
- Squeeze bottle with filtered seawater
- Sealable test tube or vial containing 10 ml of filtered seawater and two drops of neutral iodine preservative.
- Waterproof label tape or stick-on labels
- Paper towels
- Grease pencil or waterproof marking pen

#### Sampling Protocol

- Place artificial substrate at sampling site keeping the float subsurface.
- After 24 h return to the sample site and carefully remove the screen from the vertical line by releasing the snap swivel and transferring the screen to a wide mouth sample jar underwater. Hold the open sampling jar beside the screen to minimize any loss of material from the screen (Fig. 9).
- Cap the bottle, bring to surface and label with station identification, location and date.
- Record latitude and longitude, date, time and other sample information on the data sheet.
- After collection, keep samples in shade or low light and prevent excessive temperature changes. If processing is delayed by >4 h, loosen lids to allow gas exchange, avoiding spillage.

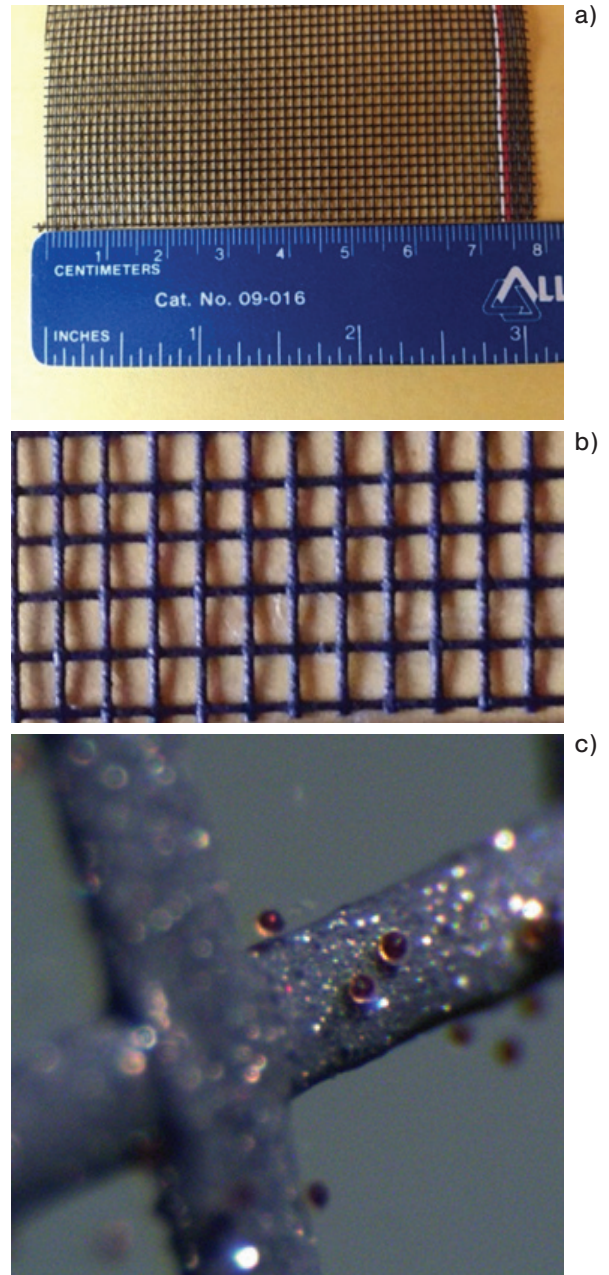
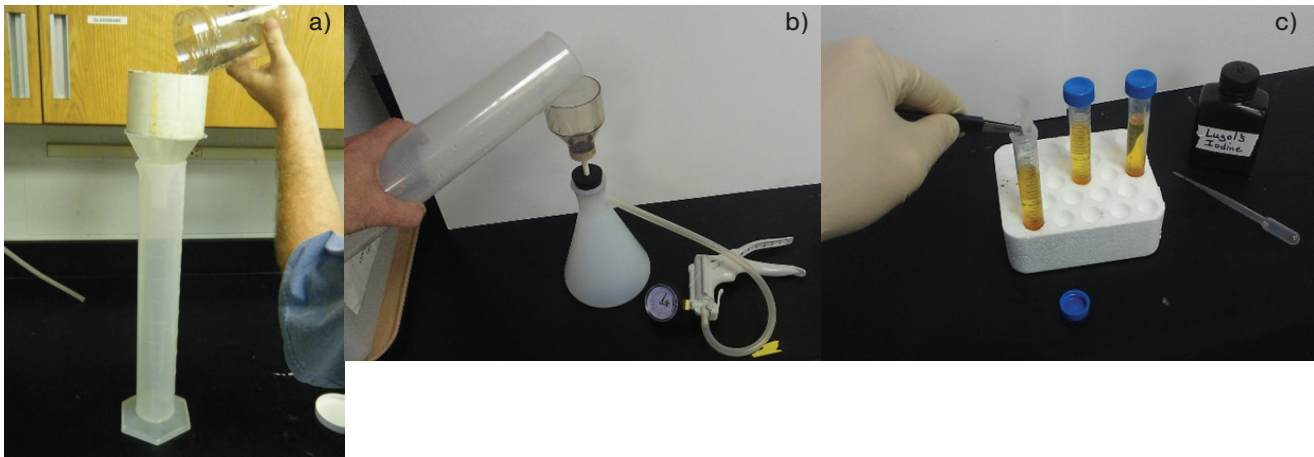

Figure 8. a) Fiberglass window screen, b) high magnification of screen, c) *Gambierdiscus* cells on fiberglass screen.



Figure 9 Sample jar with fiberglass.



**Figure 10.** a) Sieve, funnel and collection flask. Pour entire sample through 200-300 µm sieve to remove debris and grazers. b) Filtering a sieved sample through 20 µm mesh before preservation. c) Preserving a filtered cell sample in Lugol's neutral iodine solution. Add 1-2 drops to a 10 ml sample.

### Processing artificial substrate samples

Because the number of cells from the artificial substrate (screens) is expected to be fewer than on macrophytes, do not use the large surface area screens for processing the artificial substrate samples. It is recommended that samples be filtered onto 20 µm mesh placed across a 25 mm or 47 mm filter base (see below). Prepare the sample vials adding 10 ml of GF/F filtered seawater (same salinity as samples) to 15 ml conical screw cap tube and cap, then label the tube with ID and sample collection information using a permanent marker. Set aside until sample is filtered.

- Place the funnel and coarse 200-300 µm sieve (5-7 cm diameter) into the top of a 1000 ml graduated cylinder (Fig. 10a).
- Pour a portion of the sample through the sieve to create head space in the sampling jar.
- Invert the sample jar several times to suspend the particulate material and shake for 3-5 seconds to disperse clumps and suspend cells.
- Pour the entire sample through the 200-500 µm sieve into the 1000 ml graduated cylinder to remove large sediment, detritus and larger biota. At this point DO NOT RINSE the sieve, funnel or jar with seawater because it will change the sample volume.
- Discard the sieved particulates, wash the sieve and funnel with tap water and then rinse with deionized water before processing next sample.
- Record the volume (ml) of the coarse-filtered sample on the 15 ml sample tube and on the data sheet as "Sample Volume". See attached Excel file with example datasheet.
- Stir or shake the sample in the 1000 ml cylinder and filter the entire volume if possible or a subsample through a 20 µm mesh placed on top of a filter base and held in place by the filter funnel (Fig. 10b). Allow the sample to gravity filter, applying a very low vacuum pressure (<5 cm Hg), if needed, using a hand vacuum pump. If you cannot filter the whole volume of the sample, note the volume of the subsample on the sample tube and on the data sheet (see attached EXCEL file for datasheet example). If the entire sample can be filtered without clogging the 20 µm mesh, the total volume and volume filtered will be the same.
- Rinse the funnel with filtered seawater to collect all particulates onto the 20 µm mesh.
- Carefully disconnect the funnel from the base, gently take the edge of the 20 µm mesh using a pair of flat forceps and gently fold the mesh so that the cells are on the inside. Immediately transfer the 20 µm mesh to the 15 ml tube. Tap tube downward against a table top to settle the filter and make certain it is fully immersed in the seawater and add 1 drop of neutral Lugol's solution (see formulation for neutral Lugol's solution below). Cap the sample and mix by tapping on the side. Shake vigorously to mix sample and dislodge cells from the filter.
- Store the sample in the dark in a cool cabinet or at 4°C until processed. Lugol's solution will fade with time, so it will be necessary to periodically add a drop of Lugol's solution to the samples. If the iodine color is not visible, sample is no longer preserved.
- If the samples are going to be used for molecular work and stored at -80°C, then place the 20 µm mesh directly into cryovials and immediately freeze the samples. Samples frozen at -80°C will last much longer before the DNA degrades than samples preserved in Lugol's.
- Make certain the "Sample Volume" and "Volume Filtered" are recorded on both the tube and the data sheet (see attached EXCEL file for data sheet example).
- Before processing the next sample clean the forceps using a clean paper towel. If samples will be used for molecular analysis, clean forceps with dilute 10% bleach, followed by rinse with deionized from a squirt bottle, and blot on a clean paper towel
- To clean up, rinse all containers with tap water, followed by deionized water. Invert to dry. Alternatively, disposable filter funnels may be used. If samples are going to be used for molecular work, all filter funnels, supports, sieves and lab ware should be soaked in 10% bleach for 10 minutes to eliminate DNA carryover, then rinsed in deionized water and allowed to air.
- Count cells using a Sedgewick-Rafter cell or use qPCR method to determine cell abundance in the samples. Normalize cell counts to screen surface area (cells 100 cm<sup>2</sup>). See section below for estimating surface area of artificial substrate.

**Tips**

- Do not use ice or cold packs with live samples. Avoid heat, air conditioning, and excessive vibration.
- To limit cell loss during screen collection, hold the open collection jar underwater while carefully transferring the screen to the jar.
- Cut the 20 µm mesh pieces into squares in the laboratory to save preparation time.
- Avoid filtering too much material on the 20 µm mesh during filtration. If the entire sample volume cannot be filtered, note the total volume of the sample and the amount filtered on the data sheet.
- To increase the number of cells in a sample, increase the volume filtered and use a 47mm filter base and a larger piece of 20 µm mesh, although this may necessitate using a larger sample tube.

**Protocol for iodine preserved samples (neutral Lugol's)**

Follow instructions above for live sample collection, handling and processing, but with the following additions:

**Warning:** Iodine preserved samples emit corrosive vapor and adequate ventilation is required for sample storage.

- After each sample is sieved and the substrate has been removed, add 2-4 ml of iodine fixative per liter of sample (Fig. 10c).
- Replace cap and invert several times to mix. Seal with paraffin tape to limit iodine vapors.
- Store samples in the dark at 4 °C until processing.

**Estimating surface area of artificial substrate**

For the artificial substrate method using fiberglass window screen, the number of cells present are divided by the surface area of the screen. That surface area, however, is not just the screen length multiplied by its width. Instead, the three dimensional structure of the filaments and corresponding spaces must be taken into account when estimating true surface area. To do this, you will need to put the screen under a microscope with a micrometer to determine the average diameter and length of the filaments making up the screen. Once you have that information you can use the following calculations to estimate the actual surface area available for colonization by benthic HAB species (BHAB).

**Surface area of one filament Fig. 11**

$$A = 2\pi rL + 2\pi r^2$$

L represents the filament length.

For relatively long filaments, the end area ( $\pi r^2$ ) may be insignificant.

**Surface area of screen (Weisstein 2013)**

$$A\Sigma = A_xN_x + A_yN_y - N_xN_y16r^2$$

A<sub>x</sub>: Area of the x filaments

A<sub>y</sub>: Area of the y filaments

N<sub>x</sub>: Number of x filaments

N<sub>y</sub>: Number of y filaments

r: filament radius

- Measure x, the length in the x direction.
- Measure y, the length in the y direction.
- Determine N<sub>x</sub>, the number of filaments in the x direction.

- Determine N<sub>y</sub>, the number of filaments in the y direction.
- Calculate A<sub>x</sub> and A<sub>y</sub>, the filament surface areas in the x and y directions, respectively.
- Calculate the total screen surface area using the expression:

$$A\Sigma = A_xN_x + A_yN_y - N_xN_y16r^2$$

where N<sub>x</sub>N<sub>y</sub>16r<sup>2</sup> represents the approximate intersection area according to Weisstein (2013).

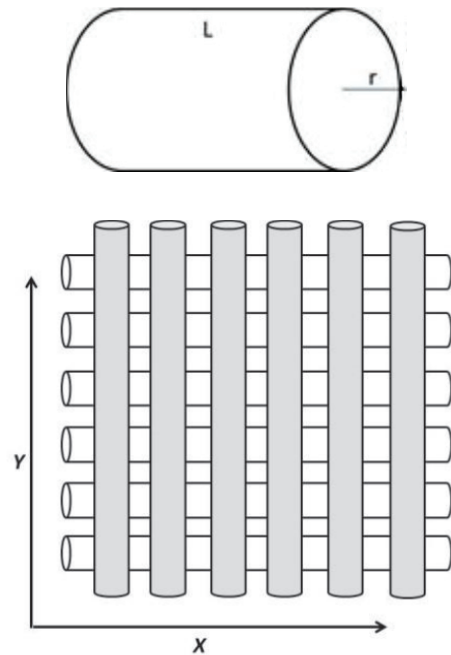

**Figure 11.** Diagram of measurements to be taken of the filaments (top) and the screen (bottom).

**Enumerating BHAB cells with the Sedgewick-Rafter slide**

**Data sheet (see attached EXCEL file)**

The attached EXCEL data sheet is constructed to accommodate cell counts from either macrophytes or artificial substrate. The macrophyte data will be reported as cells g<sup>-1</sup> wet weight algae and the artificial substrate data are reported in cells cm<sup>2</sup> (surface area of screen).

- Place a clean Sedgewick-Rafter (S-R) slide on a paper towel with the coverslip placed across the slide as in the figure below.
- Shake the fixed sample tube to disperse any cells collected on the filter. Using forceps, remove the filter mesh from the tube and discard. Rinse the forceps and wipe dry.
- Invert the tube several times to suspend the cells. Using a 1 ml pipette with a barrier tip, draw up 1 ml of sample. Be certain to pipette slowly and evenly. Do not tilt the pipette and do not immerse the tip more than ~25% of the way into the sample.
- Holding the pipette at an angle, slowly add sample to the space beneath the coverslip (arrow Fig. 12a), allowing capillary action to draw the sample beneath the coverslip

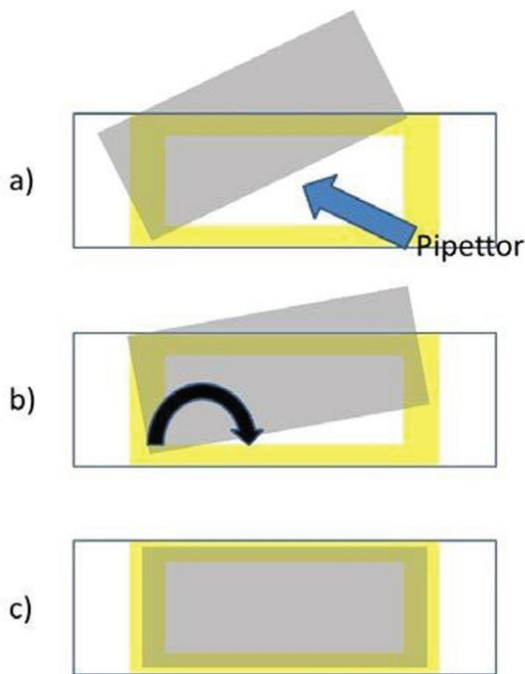

**Figure 12.** Procedure for filling a Sedgewick-Rafter slide.

a) Place the slide on a paper towel with the cover arranged as shown. Using a pipettor, slowly transfer 1.0 ml of sample to the slide as indicated by the arrow. b) While the slide is being filled, gradually rotate the coverslip into position as shown. c) When the slide is full, the cover should be centered over the chamber as shown.

into the reservoir. While dispensing, move the pipette tip across the slide, rotating the cover into place as the reservoir fills (Fig.12b).

- Make certain the coverslip is roughly centered on the slide, covering the sample completely (Fig 12c).
- Wipe the bottom and edges of the slide to remove fingerprints and drops of liquid, making sure NOT to draw any liquid out of the reservoir.
- Place the Sedgewick-Rafter slide on the microscope stage and make certain the low power objective is in position.
- Count the dinoflagellates of interest present on the slide. Record the data on the record sheet along with the volume counted.
- Carefully wash the slide and coverslip with dilute detergent, and rinse thoroughly with tap water and deionized water. Dry with a lint free laboratory wipe.
- Using new aliquots from the same sample, make two more replicate counts, and record the data on the sheet.
- If there is excessive variability among the three replicate counts, count the sample a fourth time and record the data.
- Carefully clean, rinse and dry the slide and coverslip when you are finished.

#### Calculating cell densities

- Calculate the density of dinoflagellates in the sample and make any corrections needed to account for subsampling if only counting part of the original sample.
- Once you have obtained a cell estimate per sample, divide by the wet weight of the macrophyte or the surface area of the artificial substrate to obtain cells cm<sup>-2</sup>. All of these calculations are included in the EXCEL spreadsheet.

- Cells of the EXCEL spreadsheet are:
  - A1 Sample identification
  - B1 Sample location
  - C1 Date
  - D1 Type (macrophyte or artificial substrate)
  - E1 Depth of sample (m)
  - F1 Total volume of sample (ml)
  - G1 Volume of sample filtered (ml)
  - H1 Volume of sample counted (ml)
  - I1 Final volume of sample after filtered in test tube (ml)
  - J1 Number of species A in Sedgewick-Rafter or inverted microscope count
  - K1 Number of species B in Sedgewick-Rafter or inverted microscope count
  - L1 Number of species C in Sedgewick-Rafter or inverted microscope count
  - M1 Number of all other species of dinoflagellates or species of interest
  - N1 Weight of macrophyte (g)
    - For artificial substrate use the surface area of the screen (cm<sup>2</sup>)
  - O1 Species of macrophyte or “screen” for artificial substrate
  - P1 Species A cells per wet weight macrophyte (cells/g) =  $(J7/\$H7)*(\$I7/\$G7)*(\$F7/\$N7)$ 
    - For artificial substrate, Species A cells per cm<sup>2</sup> of surface area of screen
  - Q1 Species B cells per wet weight macrophyte (cells/g) =  $(K7/\$H7)*(\$I7/\$G7)*(\$F7/\$N7)$ 
    - For artificial substrate, Species B cells per cm<sup>2</sup> of surface area of screen
  - R1 Species C cells per wet weight macrophyte (cells/g) =  $(L7/\$H7)*(\$I7/\$G7)*(\$F7/\$N7)$ 
    - For artificial substrate, Species C cells per cm<sup>2</sup> of surface area of screen
  - S1 All other dinoflagellate species cells combine per wet weight of macrophyte (cells/g) =  $(M7/\$H7)*(\$I7/\$G7)*(\$F7/\$N7)$ 
    - For artificial substrate, all other dinoflagellate species cells per cm<sup>2</sup> of surface area of screen
  - T1 Total of all dinoflagellates in the sample per wet weight of macrophyte (cells/g) =  $SUM(P7:S7)$ 
    - Artificial substrate samples are reported in cells 100 cm<sup>2</sup> so multiply those counts by 100 for reporting

#### Accuracy of the estimate

The relationship between the number of counted cells and accuracy (% of confidence limit) is shown in Table 1 in chapter 5. It is much better to count fewer higher concentration samples and average them than to do a number of lower cell count samples.

#### Acknowledgements

We would like to thank Steven R. Kibler of NOAA's Beaufort Laboratory for figures 7-12. GEOHAB's Open Science Meeting on HABS in Benthic Systems inspired our work on artificial substrates for sampling BHABs.

## References

- Adachi R, Fukuyo Y (1979) The thecal structure of a marine toxic dinoflagellate *Gambierdiscus toxicus* new genus new species collected in a ciguatera endemic area. *Nippon Suisan Gakk.* 45: 67-72.
- Boller ML, Carrington E (2006) The hydrodynamic effects of shape and size change during reconfiguration of a flexible macroalga. *J. Exp. Mar. Biol. Ecol.* 209: 1894-1903.
- Bomber JW (1985) Ecological studies of benthic dinoflagellates associated with ciguatera from the Florida Keys. M.S., Florida Institute of Technology, 104 pp.
- Chinain M, Faust MA, Pauillac S (1999) Morphology and molecular analyses of three species of *Gambierdiscus* (Dinophyceae): *G. pacificus*, sp. nov., *G. australes*, sp. nov., and *G. polynesiensis*, sp. nov. *J. Phycol.* 35: 1282-1296.
- Chinain M, Vandersea MW, Revel T, Duchiron M, Kibler SR, Holland WC, Tester PA, Litaker RW (in prep.) Semi-quantitative PCR assays for *Gambierdiscus australes*, *Gambierdiscus pacificus*, *Gambierdiscus polynesiensis* and *Gambierdiscus toxicus* (Gonyaulacales, Dinophyceae).
- Faust MA (1995) Observation of sand-dwelling toxic dinoflagellates (Dinophyceae) from widely differing sites, including two new species. *J. Phycol.* 31: 996-1003.
- Fraga S, Rodríguez F, Caillaud A, Diogéne J, Raho N, Zapata M (2011) *Gambierdiscus excentricus* sp. nov. (Dinophyceae), a benthic toxic dinoflagellate from the Canary Islands (NE Atlantic Ocean). *Harmful Algae* 11: 10-22.
- Fraga S, Rodríguez F (2014) Genus *Gambierdiscus* in the Canary Islands (NE Atlantic Ocean) with description of *Gambierdiscus silvae* sp. nov, a new potentially toxic epiphytic benthic dinoflagellate. *Protist* 165: 839-853.
- Fraga S, Rodríguez F, Riobó P, Bravo I (2016) *Gambierdiscus balechii* sp. nov. (Dinophyceae), a new benthic toxic dinoflagellate from the Celebes Sea (SW Pacific Ocean). *Harmful Algae* DOI: 10.1016/j.hal.2016.06.004
- Gómez F, Qiu D, Lopes RM, Lin S (2015) *Fukuyoa paulensis* gen. et sp. nov., a new genus for the globular species of the dinoflagellate *Gambierdiscus* (Dinophyceae). *PLOSOne* DOI: 10.1371/journal.pone.0119676
- Holmes MJ (1998). *Gambierdiscus yasumotoi* sp. nov. (Dinophyceae), a toxic benthic dinoflagellate from southeastern Asia. *J. Phycol.* 34: 661-668.
- Hallegraeff GM, Anderson DM, Cembella AD (2003) Manual on Harmful Marine Microalgae. Monographs on Oceanographic Methodology 11, UNESCO, Paris, 793 pp.
- Jauzein C, Fricke A, Mangialajo L, Lemée R (2016) Sampling *Ostreopsis* cf. *ovata* using artificial substrates: Optimization of methods for the monitoring of benthic harmful algal blooms. *Mar. Pollut. Bull.* 107: 300-304.
- Laurent D, Yeeting B, Labrosse P, Gaudechoux JP (2005) Ciguatera: a field reference guide. Secretariat of the Pacific Community, 88 pp. <http://www.spc.int/coastfish/publications/340.html> (English and French)
- Litaker RW, Vandersea MW, Faust MA, Kibler SR, Chinain M, Holmes MJ, Holland WC, Tester PA (2009) Taxonomy of *Gambierdiscus caribaeus*, *Gambierdiscus carolinianus*, *Gambierdiscus carpenteri* and *Gambierdiscus ruetzleri* (Gonyaulacales, Dinophyceae). *Phycologia* 48: 344-390. DOI:10.2216/07-15.1
- Littler DS, Littler MM (2000) Caribbean Reef Plants: An identification Guide to the Reef Plants of the Caribbean, Bahamas, Florida and Gulf of Mexico. Offshore Graphics Inc., Florida, US, 542 pp.
- Lobel PS, Anderson DM, Durand-Clement M (1988) Assessment of ciguatera dinoflagellate populations—Sample variability and algal substrate selection. *Biol. Bull.* 175: 94-101.
- Nishimura T, Sato S, Tawong W, Sakanari H, Yamaguchi H, Acachi M (2014) Morphology of *Gambierdiscus scabrosus* sp. nov. (Gonyaulacales): A new epiphytic toxic dinoflagellate from coastal areas of Japan. *J. Phycol.* 50: 506-511.
- Nishimura T, Hariganeya N, Tawong W, Sakanari H, Yamaguchi H, Adachi M (2016) Quantitative PCR assay for detection and enumeration of ciguatera-causing dinoflagellate *Gambierdiscus* spp. (Gonyaulacales) in coastal areas of Japan. *Harmful Algae* 52: 11-32.
- Quod JB, Turquet J, Diogéne G, Fessard V (1995) Screening of extracts of dinoflagellates from coral reefs (Reunion Island, SW Indian Ocean) and their biological activities. In: Lassus P, Arzul G, Erard-Le Denn E, Gentien P, Marcaillou-Le Baut C (eds) Harmful Marine Algal Blooms. Lavoisier Intercept Ltd, Paris, pp. 815-820.
- Tester PA, Kibler SR., Holland WC, Usup G, Vandersea MW, Leaw C-P, Lim PT, Larsen J, Mohammad-Noor N, Faust MA, Litaker RW (2014) Sampling harmful benthic dinoflagellates: Comparison of artificial and natural substrate methods. *Harmful Algae* 39: 8-25.
- Vandersea MW, Kibler SR, Holland WC, Tester PA, Schultz TF, Faust MA, Holmes MJ, Chinain M, Litaker RW (2012) Development of semi-quantitative PCR assays for the detection and enumeration of *Gambierdiscus* species (Gonyaulacales, Dinophyceae). *J. Phycol.* 48: 902-915.
- Weisstein EW (2013) Steinmetz Solid. Mathworld-A Wolfram Web Resource. <http://mathworld.wolfram.com/SteinmetzSolid.html> (accessed 17 February 2016).
- Yasumoto T, Nakajima I, Bagnis RA, Adachi R (1977) Finding of a dinoflagellate as a likely culprit of ciguatera. *Bulletin of the Japanese Society of Scientific Fisheries* 43: 1021-1026.
- Yñiguez A T, McManus JW, Collado-Vides L (2010). Capturing the dynamics in benthic structures: environmental effects on morphology in the macroalgal genera *Halimeda* and *Dictyota*. *Mar. Ecol. Prog. Ser.* 411: 17-31.

Annex I.

Example of an EXCEL page designed to calculate and store results from benthic HAB quantitative analyses and corresponding environmental information of the samples

ANNEX I - Example of EXCEL data sheet constructed to accommodate cell counts from either macrophytes or artificial substrate.																				
How to Calculate Cell Abundance with Macrophyte Substrate																				
Sample	Location	Date	Type	Depth	Total Vol. Sample (mL)	Vol. Filtered (mL)	Vol. Counted (mL)	Vol. in Sample Tube (mL)	Gamb	Proro	Ostreop	dinos	Other	Mass (g)	Macrophyte	Gamb cells/g	Proro cells/g	Ostreop cells/g	Other Dinos cells/g	Total Dinos cells/g
BAG 1	ALGAE Outer Twin Bays BZ09-1	01-05-2009	Algae	≤ 3 m	750	100	1	10	3	22	0	198		8,6	Chondria	26,16	191,86	0,00	1726,74	1944,77
BAG 2	ALGAE Outer Twin Bays BZ09-2	01-05-2009	Algae	≤ 3 m	750	100	1	10	38	29	0	297		11,9	Acanthophora	239,50	182,77	0,00	1871,85	2294,12
BAG 3	ALGAE Outer Twin Bays BZ09-3	01-05-2009	Algae	≤ 3 m	750	50	1	10	0	77	0	301		48,2	Thalassia	0,00	239,63	0,00	936,72	1176,35
BAG 4	ALGAE Outer TB, Edge of Main Channel BZ09-4	01-05-2009	Algae	≤ 3 m	750	50	1	10	12	69	0	307			Mix of Dictyota, Chondria & Halimeda	101,69	584,75	0,00	2601,69	3288,14
BAG 5	ALGAE Sponge Haven (Main Channel) BZ09-5	01-05-2009	Algae	≤ 3 m	750	300	1	10	2	437	10	202		8,7	Spyridia	5,75	1255,75	28,74	580,46	1870,69
BAG 6	ALGAE Large Cut (south) North Bay BZ09-6	01-05-2009	Algae	≤ 3 m	750	200	1	10	0	107	0	197		51,8	Caulerpa	0,00	77,46	0,00	142,62	220,08
BAG 7	ALGAE Large Cut (south) North Bay BZ09-7	01-05-2009	Algae	≤ 3 m	750	200	1	10	2	31	10	116		7,2	Laurencia	10,42	161,46	52,08	604,17	828,13
How to Calculate Cell Abundance with Window Screen Artificial Substrate																				
Sample	Location	Date	Type	Depth	Vol. Sample (mL)	Vol. filtered (mL)	Vol. counted (mL)	Vol. in sample tube (mL)	Gamb	Proro	Ostreop	dinos	Other	Screen Area (cm2)	Substrate	Gamb cells/cm2	Proro cells/cm2	Ostreop cells/cm2	Other Dinos cells/cm2	Total Dinos cells/cm2
JAR42	DC3 Hi-D	01-05-2009	Screen	≤ 3 m	750	100	2	10	189	417	0	162	166	166	Screen	42,70	94,20	0,00	36,60	173,49
JAR 41	DC3 Hi-D	01-05-2009	Screen	≤ 3 m	750	100	2	10	97	397	0	150	166	166	Screen	21,91	89,68	0,00	33,89	145,48
JAR 20	DC3 Hi-D	01-05-2009	Screen	≤ 3 m	750	100	2	10	116	402	0	197	166	166	Screen	26,20	90,81	0,00	44,50	161,52
JAR 43	DC3 Hi-D	01-05-2009	Screen	≤ 3 m	750	100	2	10	177	4559	0	202	166	166	Screen	39,98	1029,89	0,00	45,63	1115,51
JAR 3	DC3 Hi-D	01-05-2009	Screen	≤ 3 m	750	100	1	10	206	591	6	199	166	166	Screen	93,07	267,02	2,71	89,91	452,71
JAR 4	DC3 Hi-D	01-05-2009	Screen	≤ 3 m	750	100	1	10	76	22	2	222	166	166	Screen	34,34	9,94	0,90	100,30	145,48
JAR 5	DC3 Hi-D	01-05-2009	Screen	≤ 3 m	750	100	1	10	160	497	0	162	166	166	Screen	72,29	224,55	0,00	73,19	370,03
JAR 7	DC3 Hi-D	01-05-2009	Screen	≤ 3 m	750	100	1	10	188	607	4	237	166	166	Screen	84,94	274,25	1,81	107,08	468,07
JAR 17	DC3 Hi-D	01-05-2009	Screen	≤ 3 m	750	125	1	10	62	267	4	101	166	166	Screen	22,41	96,51	1,45	36,51	156,87
SUMMARY RESULTS - Artificial Substrate																				
					Gamb	Proro	Ostreop	Other Dinos	Total Dinos											
					cells/100cm	cells/100cm2	cells/100cm2	cells/100cm2	cells/100cm2											
					4.269,58	9.420,18	0,00	3.659,64	17.349,40											
					2.191,27	8.968,37	0,00	3.388,55	14.548,19											
					2.620,48	9.081,33	0,00	4.450,30	16.152,11											
					3.998,49	102.989,46	0,00	4.563,25	111.551,20											
					9.307,23	26.701,81	271,08	8.990,96	45,00											
					3.433,73	993,98	90,36	10.030,12	14.548,19											
					7.228,92	22.454,82	0,00	7.319,28	37.003,01											
					8.493,98	27.424,70	180,72	10.707,83	46.807,23											
					2.240,96	9.650,60	144,58	3.650,60	15.686,75											

## 4 Materials and methods for sampling phytoplankton and phytobenthos for toxin analysis

Beatriz Reguera

Instituto Español de Oceanografía, Subida a Radio Faro 50, 36390 Vigo, Spain

### Protocol 1

This procedure allows for a correlation to be made between the toxins in a sample, collected through filtration, and the estimated concentration of potentially toxic cells per unit of volume of filtered material. It therefore produces an estimation of toxin content per cell. The toxins are extracted by an analytical chemist into the same conical-bottom centrifuge tube, such as a Falcon tube (Fig. 1), in which the sample was kept. The original sample can be:

- A sample of concentrated plankton. The concentration can be done by means of a plankton net haul; filtering water from a pump through sieves stacked one on top of the other; or filtering a known volume of water through a filter.
- A plankton patch (red tide) which, due to its density, does not require prior concentration
- A sample of benthic dinoflagellates re-suspended in filtered seawater (see Chapter 3)
- A laboratory culture



**Figure 1.** Falcon tubes (15 ml and 50 ml), ideal for centrifuging concentrated plankton samples and subsequent processing to extract toxins. They can also be used to hold the folded filter.

### Material

- Plankton net with a mesh size of 20  $\mu\text{m}$ , and an additional sieve (100  $\mu\text{m}$  -150  $\mu\text{m}$ ) to remove the zooplankton
- Bottle for taking the water sample (aliquot for counting the plankton) and Lugol's solution as a fixative
- Container (e.g. plastic jug with a handle) for holding the haul
- Graduated test tubes
- Glass-fibre filters (e.g. Whatman GF/C, 1.2  $\mu\text{m}$  pore size)
- Filtration equipment, including vacuum pump and filter holder
- Laboratory forceps
- Polythene** conical-bottom Falcon centrifuge tubes, or similar, (15 ml) for storing the filter (Fig. 1). **Do not use polycarbonate tubes.**
- Freezer at  $-20^{\circ}\text{C}$
- Methanol (certified analytical quality) for fat-soluble toxins (e.g. DSP toxins) or a solution 0.1 N of  $\text{Cl}_2\text{H}$  for water-soluble toxins (e.g. PSP toxins).

### Method

- Do a vertical haul using a plankton net with a mesh size of 20  $\mu\text{m}$ . In the case of a plankton patch (red tide) or mono-algal culture, the sample is directly processed without the need for prior concentration.
- Pour the haul into a jug with a handle, or a similar container, and then through a sieve of 100 - 150  $\mu\text{m}$  to remove large microzooplankton organisms that interfere with the analysis. Make sure that the material is well mixed. If the sample is not filtered on board the vessel, dilute the haul with surface seawater, keep it in a glass container inside a portable ice-box/cooler or in a cool place. Otherwise, the cells in the haul might begin to break apart and the toxins will be released into the water and be lost.

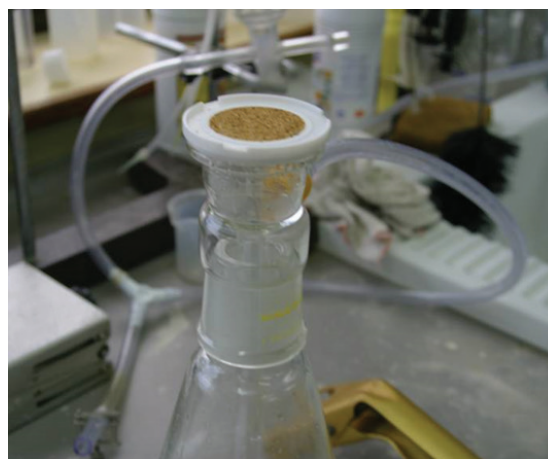

**Figure 2.** Filtration equipment (filter holder) with a vacuum pump connected to the water tap in the sink. Right: colour of plankton accumulated in the glass-fibre filter (Photo: P. Riobó).



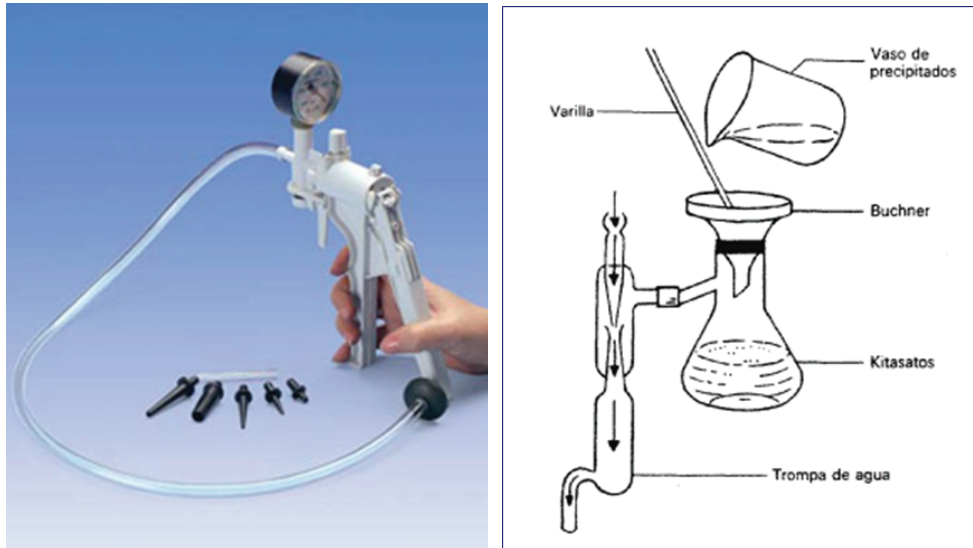

Figure 3. Left: manual vacuum pump. Right: filtration system with a water pump.

- 3) Before filtering, take an aliquot (subsample) of 100 ml in a tinted or UV-resistant bottle and fix it with Lugol's solution at 0.5%. In the case of a patch or culture, a much smaller volume (10 ml) is taken. This sample is for the quantitative analysis of microalgae.
- 4) Take a set volume (measured using the test tube) of the haul (or suspended benthos or culture) and filter it through a glass-fibre filter with a vacuum pump (e.g. Millipore), making sure that all the water has been filtered into the final sample. Write down the filtered volume (V). Holding the filter holder, seize the edge of the filter with the forceps and fold it over itself two or more times. Using the same forceps, take the folded filter and carefully insert it into a conical-bottom centrifuge tube with a screw cap (e.g. Falcon).
- 5) Pour, until the filter is thoroughly wet, a measured volume of certified analytical quality methanol, in the case of lipophilic toxin analysis (e.g. DSP, ciguatera), or, for hydrophilic toxin analysis (e.g. PSP, ASP), a hydrochloric solution (Cl H) 0.1 N.
- 6) Immediately place the sample in a freezer at -20°C and keep it there until it is time for transport/analysis.
- 7) Estimate the concentration (C) (with a Sedgewick-Rafter counting chamber; average of three 1-ml counts) of potentially toxic cells per unit (cells/ml) of sample volume from the haul/red tide patch/re-suspended benthos/culture.
- 8) Estimate the number (N) of potentially toxic cells in the filter.

$$N = C \times V$$

Where N is the number of potentially toxic cells contained in the filter; V is the filtered volume (ml) and C is the concentration of potentially toxic cells (cell/ml) present in the filtered sample.

**Before transporting/sending:**

Cover the mouth of the tube with Parafilm to prevent loss through evaporation. Close with the screw cap, making sure that it is securely tightened.

**Important considerations:**

- The higher the concentration of cells per unit of volume, the less volume it will be necessary to filter. Otherwise, the filters will become clogged. As regards chromatographic analysis, a sample of 10–20 ml is sufficient in the case of a monoalgal culture or a dense patch (red tide). The case of hauls is more complex because there might be a lot of accompanying material (e.g. diatoms, detritus) making filtration difficult, as well as few potentially toxic cells.
- The aliquot of the haul/red tide patch/culture fixed with Lugol's iodine is for estimating the concentration of potentially toxic cells (C) so that the number (N) of cells in the filtered volume (V) of the haul/red tide patch/culture can then be estimated.
- Ideally, the sample should be filtered (step 4) as soon as it has been taken. If this is not possible, make sure that the sample arrives in good condition before filtering. **There is no point** taking a sample that is fixed with Lugol's iodine (step 3) hours before it is filtered (step 4) if the sample is to be counted, since the cells present in each sample will not match (cells in the haul or patch will die and burst during the wait).
- Instead of a haul, seawater samples can be filtered directly. However, if potentially toxic cells are present in low concentrations (< 10<sup>3</sup> cell/l), or if there is a lot of accompanying material, the filters can become clogged long before a sufficient number of toxic cells has been filtered to enable their detection through available analytical methods.
- The filtration equipment and filters used for this technique are the same (except the pore size, which is 0.45 µm for chlorophylls) as those used for filtering water for chlorophyll analysis. However, if such equipment is unavailable or, in particular, if dense samples of laboratory cultures are being filtered, small manual filtration pumps can be used, or a homemade vacuum pump can be set up by connecting the filter holder to a water tap (Figs. 2 and 3).
- Polycarbonate tubes are very fragile and deteriorate with freezing/thawing. They often crack and break when an analyst is centrifuging them.

## Protocol 2

The procedure is exactly the same as in Protocol 1 except that the concentrated sample of microalgae (haul/red tide patch/re-suspended benthos/culture) is centrifuged instead of being filtered. Thus, instead of step 4 of Protocol 1, the procedure is as follows:

- 1) In conical-bottom centrifuge tubes (e.g. Falcon), centrifuge a known volume of the concentrated microalgal sample (haul/red tide patch/re-suspended benthos/culture) for ten minutes at 1,000 rpm in the case of unarmoured microalgal species (e.g. *Gymnodinium catenatum*), which burst easily, and up to 2,000 rpm in the case of thecate dinoflagellates (e.g. *Alexandrium* spp., *Pyrodinium bahamense*).
- 2) Remove the supernatant, making sure that the water has been thoroughly removed from the pellet.
- 3) Re-suspend the pellet with methanol (lipophilic toxins) or with Cl H 0.1 N (hydrophilic toxins) to extract toxins in the same tube in which the sample was centrifuged.
- 4) Keep it in the freezer at -20°C until it is time for analysis/transport.

### Precautions:

- Very important: Examine the supernatant with a microscope to ensure that all the cells have settled. If this is not the

case, it will be necessary to quantify the cellular concentration in the supernatant and subtract it from the number of cells N estimated to be in the pellet. If this precaution is not taken, the quantitative estimation of toxins per cell will not be reliable.

- Some chain-forming dinoflagellates, such as *G. catenatum*, are very good swimmers and, when they undergo gentle centrifugation (with the aim of not breaking cells), they escape by swimming to the surface of the tube.

## Protocol 3

The procedure is exactly the same as in Protocol 1 except that the concentrated sample of the haul/red tide patch/re-suspended benthos/culture is lyophilized (i.e. freeze-dried). Step 4 of Protocol 1 is thus replaced by freeze-drying a known volume of concentrated microalgae (haul/red tide patch/re-suspended benthos/culture).

### Considerations:

This process is very convenient for transporting samples and highly recommended for processing large samples of mollusc flesh. In the case of small samples of plankton, lyophilized samples sometimes cause interference in the analysis because proteins and fats can change during the freeze-drying process.

## 5 Quantitative analysis of microalgae: General considerations

Beatriz Reguera<sup>1</sup>, Silvia Méndez<sup>2</sup> and Rosalba Alonso<sup>3</sup>

<sup>1</sup>Instituto Español de Oceanografía, Subida a Radio Faro 50, 36390 Vigo, Spain (beatriz.reguera@vi.ieo.es)

<sup>2</sup>Dirección Nacional de Recursos Acuáticos, Constituyente 1497, 11200 Montevideo, Uruguay (smendez@dinara.gub.uy)

<sup>3</sup>Universidad Nacional Autónoma de México, Unidad Académica Mazatlán, Av. Joel Montes Camarena s/n, Col. Playa Sur, Mazatlán, 82040 Sinaloa, México (rosalba@ola.icmyl.unam.mx)

The aim of quantitative analyses of microalgae is to obtain the most accurate estimation possible of the number of organisms of each species per unit of volume. Microalgal species in field samples are frequently found in concentrations that make it difficult to observe them directly by means of traditional methods of optical microscopy. It is therefore necessary to concentrate the samples before analysing them.

The usual concentration methods are:

- Filtering through sieves or filters with a mesh/pore size that depends on the size of the organisms under study. Note down the initial volume ( $V$ ) and the final volume ( $v$ ) in order to estimate the conversion factor.
- Centrifugation of a known volume of sample ( $V$ ), removal of the supernatant (after verifying that cells have not been lost) and resuspension of the pellet in a smaller volume ( $v$ ) of water. Note down the initial volume ( $V$ ) and the final volume ( $v$ ) in order to estimate the conversion factor.
- Sedimentation of a known volume of water in a calibrated area.

Filtrations through nets or sieves are selective methods that select organisms of a determined size-range. They are recommended for the monitoring and early detection of potentially toxic microalgae of medium size ( $> 40 \mu\text{m}$ – $50 \mu\text{m}$ ) present in low concentrations.

Concentrating microplankton by means of centrifugation may be appropriate for species that are not delicate (they can burst during the process), but this method requires immediate processing of the live sample as soon as it arrives at the laboratory, and observation of the supernatant to check that cells do not remain suspended. As in the case of concentration by means of filtration, this method enables quick observation of the sample.

The sedimentation of a known volume of water and, in particular, the Utermöhl method (see next section), is the standard technique, frequently used in research and monitoring programmes that require quantitative phytoplankton analysis. This method involves the use of an inverted microscope, in which the objectives are positioned underneath the stage holding the sample (Fig. 1).

Field samples are usually fixed with various fixatives and preserving agents that serve a double purpose: a) to preserve the sample until analysis; b) to increase the contrast of the cells, many of which are translucent, in order to facilitate their observation and identification. Microscopes can be equipped with optical systems that enhance contrast, such as phase contrast and Nomarski microscopy (also known as differential interference contrast – DIC). In addition, they can have

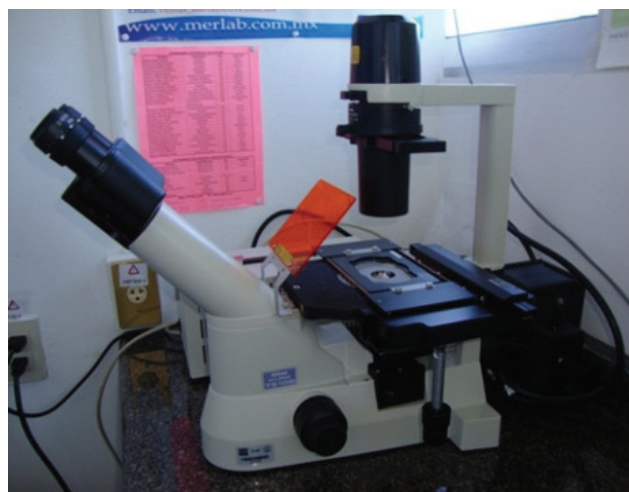

Figure 1. Inverted optical microscope with an epifluorescence system attached.



Figure 2. Compound microscope.

fluorescence equipment attached, which enables in vivo observation of the autofluorescence of pigmented species, or of fluorescence resulting from fluorochromes (e.g. calcofluor-white, DAPI, SYBR Green) that stain specifically determined molecules that make up organelles and theca.

This guide explains how to carry out quantitative analyses using Sedgewick-Rafter chambers directly on a compound microscope (Fig. 2) or with an inverted microscope and sedimentation chamber, using the Utermöhl method.

### Counting cells with Sedgewick-Rafter chambers

The Sedgewick-Rafter counting chamber is a traditional method for counting cells. It is comprised of a transparent base, which has a mounted chamber measuring 50 mm x 20 mm x 1 mm, whose capacity is therefore 1000 mm<sup>3</sup> = 1 cm<sup>3</sup> = 1 ml. The chamber is covered with a coverslip. The Sedgewick-Rafter chamber is ideal for counting cells with a size range of 20 µm–500 µm, both directly with an optical microscope and with an inverted one. The chambers can be glass or plastic. The latter are much less expensive (\$40–\$50 each) but tend to scratch with use, making observation difficult. Modern Sedgewick-Rafter counting chambers have a ruled grid of 50 columns and 20 rows, dividing its area into 1,000 squares of 1 mm<sup>2</sup> (Fig. 3.). The grid enormously facilitates the enumeration of dense samples (>10<sup>3</sup> cell ml<sup>-1</sup>) by enabling you to count small fractions of the total chamber (e.g. three rows, even or odd squares in three rows, and so on).

If you count all the cells contained in the chamber, whose capacity is 1 ml, the resulting values are cells per ml.

If the sample is very dense, several rows are counted (50 squares per row), and the density is estimated according to the following equation:

$$D \text{ (cell/ml)} = \frac{\text{no. of counted cells}}{\text{no. of scanned squares}} \times \frac{1000 \text{ squares}}{1 \text{ ml}}$$

where *D* = cellular density (cells/ml)

Using a Sedgewick-Rafter chamber is an appropriate counting method to estimate cellular density in field samples with high biomass (>10<sup>5</sup> cell · l<sup>-1</sup>) and in cultures. It is inappropriate for field samples with low concentrations of phytoplankton.

#### Guidelines for counting:

##### 1. Homogenize the sample.

Taking the field sample (or culture sample) fixed with Lugol's iodine, gently turn the container upside down so that the chains or colonies do not break and bubbles do not form.

##### 2. Make sure that the sample is evenly distributed in the chamber.

The sample can be dispensed with a wide-mouthed pipette (e.g. a Pasteur plastic disposable pipette) held perpendicularly to the chamber, at a slight inclination, in the top left corner (or the bottom right one). Put the coverslip on diagonally so that only a small triangle in the top left corner and another in the lower right corner remain uncovered (see Fig. 12 in chapter 3). If the cells are large or chain-forming, the narrow neck of the pipette can cause a build-up of cells that will result in a contagious distribution (i.e. a greater quantity of cells in the corner where the sample was unloaded). Alternatively, very quickly pour an aliquot of slightly more than 1 ml into the centre of the chamber, and cover immediately with a coverslip. In this way, a very homogeneous distribution can be achieved.

##### 3. Count a sample size that gives statistically reliable results.

Counting 100 cells will give a 95% confidence interval of the estimate with a margin of error of + 20%, while counting 400 cells produces a margin of error of + 10% (Venrick 1978a).

##### 4. In the case of chain-forming organisms, it is advisable to count an entire chamber.

The length of the chain is a very interesting piece of information that usually indicates the “health” of the culture. If the cellular density is very high, the sample can be diluted before being counted. Do not forget to multiply by the dilution factor afterwards!

1	2	3	4	5	6	7	8	9	10	11	12	13	14	15	16	17	18	19	20	21	22	23	24	25	26	27	28	29	30	31	32	33	34	35	36	37	38	39	40	41	42	43	44	45	46	47	48	49	50						
2																																																							
3																																																							
4																																																							
5																																																							
6																																																							
7																																																							
8																																																							
9																																																							
10																																																							
11																																																							
12																																																							
13																																																							
14																																																							
15																																																							
16																																																							
17																																																							
18																																																							
19																																																							
20																																																							

Figure 3. Grid (20 rows, 50 columns) of a Sedgewick-Rafter counting chamber.

5. If the sample of loose cells is very concentrated, count several rows, or even the odd (or even) squares in several rows. Choose rows that are arranged symmetrically in the chamber (Fig. 3). For example, if you have decided to count three rows, count the third, seventh, tenth and seventeenth. In the case of five rows, count the third, seventh, tenth, thirteenth and seventeenth rows. You can also decide to count columns (following the same rules).

6. If you count cells per square, or cells per row, consistent rules must be followed regarding how to count cells that touch the separation lines:

Rows: Count all the cells that touch the upper line, but not those that touch the lower line (or vice versa).

Squares: Count the cells that touch the top and left side of the square, but not those that touch the bottom and right side (or vice versa).

7. Count two or three aliquots per sample.

If the data vary more than by 10%-15%, it may be suspected that the samples were poorly distributed or improperly handled.

#### A practical example of calculating concentration:

After pouring a sample of a culture of *Alexandrium minutum* into the Sedgewick-Rafter counting chamber, we counted 213 cells in row three, 198 cells in row ten and 205 cells in row 17 (the three shaded rows in Fig. 3). What is the cellular density?

$$D = \frac{(213 + 198 + 205) \text{ cell}}{(3 \times 50) \text{ squares}} \times \frac{1000 \text{ squares}}{1 \text{ ml}} = 4106 \text{ cell/ml}$$

### The Utermöhl method using sedimentation chambers

The Utermöhl method is the standard and most frequently used method to identify and enumerate microalgae in water samples. It is based on the sedimentation of an aliquot of known volume (5 ml, 10 ml, 25 ml, 50 ml or 100 ml) of a water sample in a sedimentation chamber (Fig 4). Gravity causes the cells, fixed with preserving agents (e.g. formalin, Lugol's iodine), to fall and settle on the round bottom of the sedimentation plate. It is assumed that the particles will settle in a Poisson distribution. The settled cells can be identified and counted under an inverted microscope. The estimated concentration is expressed as cells per millilitre (ml) or per litre (l).

The settled sample presents a mixture of organisms which, on the basis of their size, are classified as micro- (20 µm–200 µm), nano- (2 µm–20 µm) or picoplankton (0.2 µm–2.0 µm), and which present increasing levels of abundance. Counting large and scarce taxa (50 µm–100 µm) requires scanning the entire bottom of the sedimentation chamber at a magnification of 100. In the case of small and abundant cells (10 µm–50 µm), which are observed at a magnification of 250 or 400, it would be unfeasible to count all the specimens settled at the bottom of the chamber, which is why we count the ones present in one or more diameter transects. To count small cells (< 10 µm), it may be necessary to use an immersion objective



**Figure 4.** a) Simple sedimentation chambers of 25, 10 and 5 ml; b) Combined sedimentation chambers: bottom sedimentation plate with cover slide and key to unscrew the metallic ring (front) and sedimentation cylinders of 10, 25, 50 and 100 ml (rear)

(1,000 x). Specimens contained in different squares (seen in the reticle inserted into the eyepiece) can be counted in randomly chosen parts of the bottom plate.

It is necessary to estimate the area (s) of the scanned diameter transect or the reticle and what fraction (s/S) of the area of the bottom plate (S) they represent (see Box 2). In other words, **it is necessary to calibrate the microscope and determine conversion factors (f)** to apply for all the microscopes, the reticles in their eyepieces, the surface area of the base plate, the settled sample volume and the magnifications used.

#### Sample bottles

Water samples for phytoplankton analysis are kept in wide-mouthed bottles with screw caps. If the samples are fixed with Lugol's solution and analysed quickly (e.g. a few days after samples are taken), plastic containers can be used. Otherwise, they should be avoided because plastic absorbs Lugol's iodine and other fixatives. If samples will be stored for longer periods of time, glass containers with plastic lids must be used. They can be made of tinted or transparent glass. Clear glass allows for easy monitoring to see if the sample has kept its characteristic colour tint, or if more Lugol's solution needs to be added. In any case, in order to prevent the degradation of Lugol's iodine, samples must not be exposed to light but, rather, stored in the dark. Alternatively, borosilicate (Pyrex) containers can be used, which absorb ultraviolet light (providing UV protection) and keep Lugol's solution in good condition for months. They are, however, more costly.

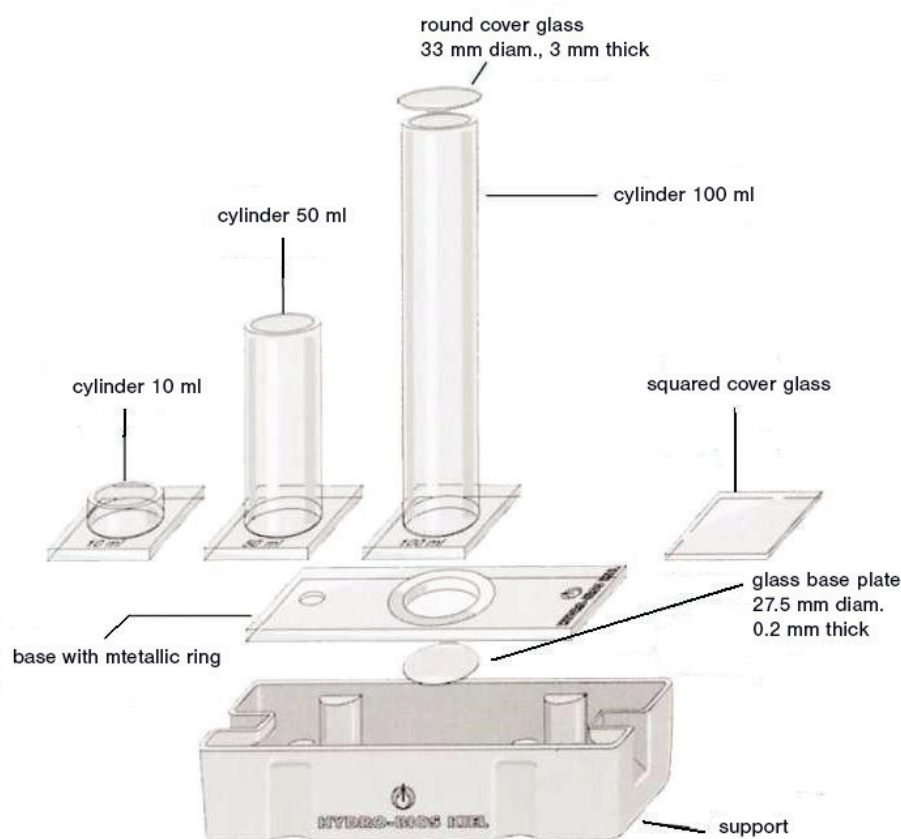

**Figure 5.** Different parts of combined sedimentation chambers

It is important to make sure that the bottle cap is securely tightened to avoid spillage and loss through evaporation. If the container is not completely filled, this facilitates the homogenization of the sample before it is poured into the sedimentation chamber.

### **Preserving agents**

The fixative should be chosen according to the purpose of the study. There is no universal fixative that can keep all groups of microalgae in a good state. The most commonly used one is potassium iodine—or Lugol's iodine solution—acidic, neutral or alkaline. To preserve samples for long periods of time, a neutral formaldehyde solution (formalin) must be used. If the samples are going to be investigated later under an electron microscope, the recommended fixative is glutaraldehyde.

### **Sedimentation chambers**

A sedimentation chamber consists of two parts, namely a cylinder (or chimney) and a bottom plate. The chamber is usually made of methacrylate in volumes of 5, 10, 25, 50 and 100 ml. The glass base plate must be very thin (0.2 mm) to allow for observation with an inverted microscope. There are simple and combined sedimentation chambers (Figs. 4 and 5). In the case of simple chambers, the liquid of the fixed sample that stays in the cylinder interferes a little with seeing the settled sample on the plate. In the case of combined chambers, the cylinder slides and the liquid, free of particles since they have already settled, is removed before observation of the plate, resulting in clearer viewing.

Commercially available sedimentation chambers, in particular combined ones, are very expensive. Different countries and laboratories sometimes arrange to have their sedimentation chambers made by local craftsmen at a much lower price. The thin glass for the base plate can be obtained from watchmakers. It is important that the volume of the chamber is perfectly calibrated. The procedure involves first weighing the chamber while empty (i.e. tare) and then when filled with water. The difference (in grams) will be equal to the volume (in ml) of water placed there to settle.

### **Sample homogenization**

Before pouring the sample into the sedimentation chamber, make sure that the particles suspended in the water are homogeneously distributed. The bottle should be firmly shaken and turned upside down 30–50 times, gently to avoid the break-up of colonies or the formation of bubbles. Quality control exercises of this step can be arranged: three aliquots from the same container can be provided to each analyst and variations in the counts can be checked.

### **Concentration/dilution of samples**

Some highly diluted samples would be easier to count after a process of concentration; other very concentrated samples would be more convenient to count if they were diluted. Every additional step, however, means adding a new source of possible error. In general, it is preferable to use sedimentation chambers (or transect scans) of various sizes depending on the abundance of the species to be counted. In rare cases, an

additional sampling strategy can be used for the early detection of low-biomass populations of potentially toxic species (e.g. *Dinophysis* spp.). It consists of concentrating the samples by size classes through sieves and then re-suspending them in known volumes of water in a method similar to that for the sampling of benthic microalgae (see chapter 3).

### Filling the chambers, sedimentation and emptying the cylinders

- On a smooth, level surface, fit together the plate and cylinder of the sedimentation chamber, their round edges precisely lined up one on top of the other.
- Fill the chamber immediately after the sample homogenization (not longer than the few seconds it takes to open the container), otherwise the heavier particles will start to settle in the container.
- Firmly hold the chamber, grasping the cylinder with your thumb and index finger as close as possible to the base, and pressing downwards. In the case of combined chambers, press the cylinder, which is well positioned on the plate, downwards, so that the liquid does not leak when being poured.
- Overfill the cylinder so that when the thick circular cover glass is slipped on top, air bubbles do not form inside. A bit of paper towel can be placed next to the base in order to absorb the excess liquid spilled during this step. Some experts lightly grease the bottom of larger cylinders (100 ml) with Vaseline to ensure that they stay tightly attached to the base plate.
- The sedimentation time depends on the height of the cylinder and the fixative used (particles fixed with Lugol's solution weigh more than other fixatives). A rule of thumb is to let samples preserved with Lugol's iodine settle for as many hours as the height of the cylinder, in cm, multiplied by three (Box 1).
- To empty combined chambers, place them in a cylindrical or cubic support, making sure that the circular emptying hole is positioned above a suitable place for drainage. Place the square cover glass to the right of the plate and slide it (a trick to help with slippage is to add a few drops of filtered seawater to this spot). Firmly push the cover glass onto the plate, from right to left, until the cylinder is above the drainage hole and the upper part of the plate is perfectly covered by the square cover glass.

The samples must be left to settle in a place with a stable temperature (controlled if possible), protected from direct exposure to sunlight, air currents and so forth. Any physical disturbance might generate convection currents in the liquid of the sample, bubbles and other inconveniences that could affect the homogeneous sedimentation of the particles.

It is recommended to look at the excellent illustrations of this process presented in Villafañe and Reid (1995).

### Cleaning the sedimentation chambers

The sedimentation chambers should be cleaned immediately after sample analysis to prevent salt precipitate formation and the deterioration of metal components. Use a soft brush, such as those used for visual arts, and a neutral detergent. The edge of the circular base plate can be cleaned with a toothpick. If necessary, unscrew the metal ring with the key that came with the set of chambers and accessories at purchase.

Precautions: Special care must be taken with cleaning if the chambers have been used to count samples containing microalgae that produce mucilage, such as benthic dinoflagellates and some colony-forming diatoms. They can stick to the thin bottom glass and remain there even after it is washed.

### Inverted microscope

Quantitative analyses that require sedimentation chambers must be conducted with a good-quality inverted microscope. Phase contrast microscopy or, even better, Nomarski microscopy, which is differential interference contrast (DIC) microscopy, increases the contrast and enables you to identify the morphological features of phytoplankton cells more easily, except in the case of coccolithophorids, which, on account of their calcareous theca, are observed more effectively through light microscopy (LM). Epifluorescence microscopy, which is used to observe dinoflagellates dyed with the fluorochrome calcofluor-white, has contributed tremendously to the identification of armoured species, whose cellulose plates fluoresce blue when a UV-light filter is used. Such observation allows for the description of details needed to identify the species according to plate nomenclature.

If an epifluorescence system is unavailable, the traditionally used alternative method consists in treating the sample of armoured cells with sodium hypochlorite (i.e. bleach) and observing them through bright-field illumination under an optical microscope.

#### Box 1: Utermöhl method (sedimentation chambers) V of the chambers (sample size): 5–100 ml

- Sedimentation time: 3 h x height of the cylinder in cm (in samples fixed with Lugol's iodine)
- Detection level: 1000/ V of the cylinder (ml)

Cylinder	Detection Level
100ml	10 cells/l
50 ml	20 cells/l
25 ml	40 cells/l
10 ml	100 cel/l
5 ml	200 cel/l

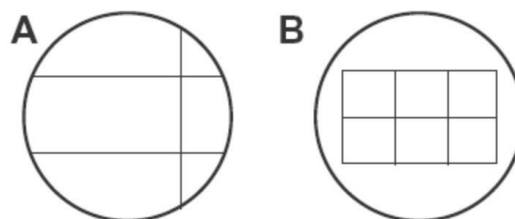
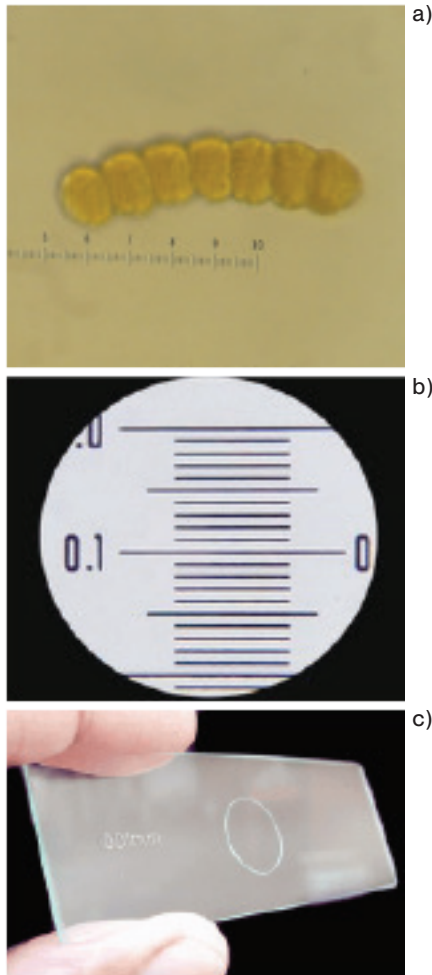

Figure 6. Counting aids mounted in the eyepiece to facilitate scanning and specimens' counting: a) parallel threads with a transverse thread for diameter transects; b) grids

For counting, it is extremely helpful to have one eyepiece equipped with a calibrated ocular micrometre (to measure the size of the specimens). The other eyepiece can be fitted with an accessory consisting of two parallel lines and a perpendicular one that form a transect (to facilitate scanning from one side of the base of the chamber to the other) (Fig. 6). The eyepiece can also be equipped with a reticle or grid to facilitate the counting of small areas of abundant and very small organisms (pico- and nanoplankton). All these counting aids must be calibrated for each magnification, on each microscope, by measuring with a stage micrometer (Fig. 7).

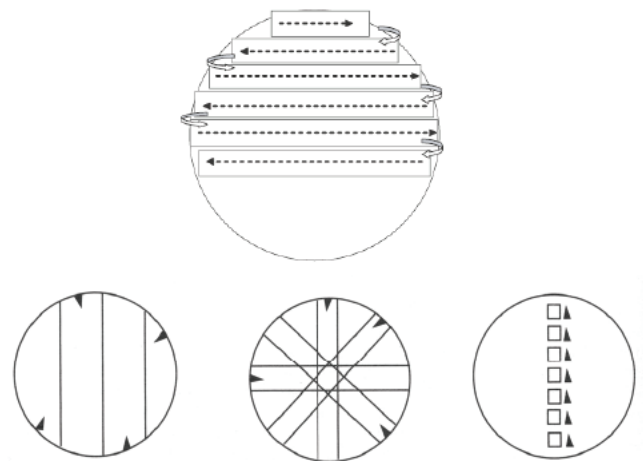

**Figure 7.** a) Ocular micrometer over a chain of *Cochlodinium* sp. to measure cellular dimensions; Objective micrometer as seen from the ocular (b) and on the hand (c).

**Counting procedure**

1. Do a quick scan of the chamber bottom at a low magnification (40 x) to get an idea of the density and distribution of the cells (Fig. 8). This quick overview enables you to:
  - Determine whether the cells are evenly distributed. Cells grouped in a heterogeneous way could indicate poor laboratory practices in the handling of the sample (e.g. homogenization, pouring) or that the work table is not level.
  - Make a note of large and scarce species that will be counted by scanning the whole surface of the plate.

2. Identify the organisms at the lowest possible taxonomic level (genus, species or even the life-cycle stages of a species).
3. Begin with a count of large and scarce species (e.g. *Dinophysis* spp., *Ceratium* spp.) by scanning the whole surface of the plate at a low magnification (100 x). The scan is done by sweeping horizontally from left to right, and from right to left (Fig. 8). Every time the scan reaches the end of a transect on the right, go down, using the coaxial adjustment knob, a distance equal to the diameter of the field of vision or the eyepiece diameter (examine a detail of the sample on the edge of the chamber before moving the field of vision down). You can then begin to scan the next transect from right to left and continue in this way until the entire bottom of the chamber has been observed.
4. Next, count smaller and more plentiful species by scanning diameter transects at a greater magnification (400 x). To ensure that the scan is diametrical (i.e. passing through the middle point of the base), the vertical end of the transect must be positioned on the sedimentation-plate tangent, which is seen as a straight line (not curved), thus indicating that you are at the end of the diameter.
5. Lastly, scan various grid squares to count the smaller specimens.
6. The number of cells of each taxon and the factor to apply (which depends on the scanned area) must be carefully noted in the EXCEL spreadsheet to facilitate estimates of cellular concentrations (Box 2).



**Figure 8.** Top: Counting of the whole bottom of the sedimentation chamber with the parallel eyepiece threads indicating the counted area. Bottom: Scheme of different counting possibilities: the whole bottom of the sedimentation chamber (left), diameter transects (centre) and a series of grids (taken from Edler and Elbrächter 2010).

When counting by making scans of the whole plate, or of diameter transects, it is important to be consistent regarding the criterion to apply to cells that are found in ambiguous positions (e.g. part of the cell inside and part outside the boundaries of the transect). The strongest criterion, from a statistical point of view, is deciding that cells in contact with the upper edge of the transect should be counted, while those found on the lower edge should be omitted. When scanning squares, count the ones that touch the upper and left sides and omit those that touch the lower and right sides (or vice versa).



**Box 2: Estimating the factors to apply in microalgal counts in sedimentation chambers**

1. Estimating the area of the sedimentation plate

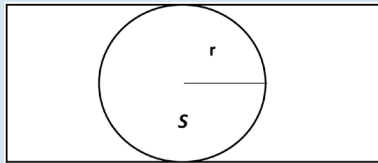

$$S = 3.14 r^2$$

$$(r = 13 \text{ mm})$$

$$S = 3.14 \times 169 = 531 \text{ mm}^2$$

2. Calculating the area of a diameter transect of the plate

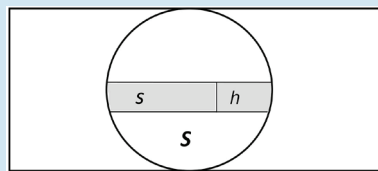

$$s = 2r \times h = 26 \times h \text{ (mm}^2\text{)}$$

$h$  = width of the field of vision of the eyepiece (or of the reticle in the eyepiece)

These parameters must be calibrated for every microscope, with their different objectives (magnifications), using a stage micrometer.

3. Calculating the factor to apply when counting diameter transects

- if in  $s$  there are  $n$  cells
- in  $S$  there will be  $N$

$$N = n \times S/s = n \times f$$

$n$  is the number of cells counted in the area  $s$  of the transect.

$N$  will be the quantity estimated for the whole bottom of the base ( $S$ ).

The  $f (S/s)$  factor is different for **every objective** of the microscopes used.

Once the factor  $f$  has been estimated, multiply by a conversion factor, which will vary according to the volume of the cylinder used, in order to estimate the concentration in cells per litre:

$\times 10$  (100-ml cylinder),  $\times 20$  (50-ml cyl.),  $\times 40$  (25-ml cyl.) or  $\times 100$  (10-ml cyl.).

**Detection level and precision of counts in the quantitative analysis of microalgae**

The larger the size of the settled sample (size of cylinder), the greater the detection level for the sample will be. When the number of cells on the entire bottom of the plate is known, a factor (which depends on the cylinder size used) is applied to estimate the concentration (cells/l).

**Table 1.** Relationship between number of counted cells and confidence limit (at 95%) (Edler and Elbrachter 2010).

No of counted cells	Confidence limit +/- (%)	Absolute limit if cell density is estimated at 500 cells L <sup>-1</sup>
1	200	500 ± 1000
2	141	500 ± 705
3	116	500 ± 580
4	100	500 ± 500
5	89	500 ± 445
6	82	500 ± 410
7	76	500 ± 380
8	71	500 ± 355
9	67	500 ± 335
10	63	500 ± 315
15	52	500 ± 260
20	45	500 ± 225
25	40	500 ± 200
50	28	500 ± 140
100	20	500 ± 100
200	14	500 ± 70
400	10	500 ± 50
500	9	500 ± 45
1000	6	500 ± 30

To obtain a statistically robust result from the quantitative analysis, it is necessary to count a specific number of cells (or colonies, or filaments). Precision is expressed as a confidence level (+ n%) with a confidence limit of 95% (Table 1). For instance, if we count 50 cells of *Pyrodinium bahamense* in a sample, the precision of the count is + 28%; if we count 100 cells, it is + 20%; if we count 200, + 14%; and if we count 400, it is + 10%. The scientist or agency responsible for overseeing the quality of the counts will set standards and the precision level that must be attained in estimates. It may, for example, be decided that it is not worth counting 400 (instead of 200) cells if this means gaining 4% (from 14% to 10%) in precision (confidence limit).

**Calibrating counting systems and quality control of analyses**

**Calibrating the counting systems**

Using different methods for identifying and counting microalgae requires a rigorous review of the different sources of variation associated with the complete process, from the sample homogenization and concentration (i.e. pouring it into counting chambers and/or sedimentation chambers) to the concentration estimates (cell · l<sup>-1</sup>) for each species. In some countries, laboratories responsible for controlling the quality of seafood for human consumption, and those that monitor water quality, must go through rigorous national certification processes for the technical standards used in quantitative analyses of potentially harmful microalgae and analyses of phycotoxins in bivalves.

The most widely accepted standard technique for quantitative microalgal analysis is the Utermöhl method. Accreditation on the use of this method involves developing protocols with levels of traceability and reproducibility in line with defined criteria. The protocols must describe the following steps in detail:

- **Sample homogenization:** Turn the container upside down, gently and regularly at least 30 times, to prevent the break-up of colonies and the creation of bubbles.
- **Concentration/dilution of the sample:** This is not recommended because it introduces a new source of variability. It is preferable to use larger sedimentation chambers (50–100 ml), even if this increases the sedimentation time before the analysis can be conducted.
- **Sample sedimentation:** Sedimentation times for each size of calibrated cylinder and type of fixative used; environmental conditions in the place where the samples are left to settle (e.g. stable temperature to avoid convection currents, no air currents or direct exposure to sunshine).
- **Process for emptying the cylinders:** It applies when combined sedimentation chambers are used.
- **Counting procedure:** Calibration of the sedimentation chambers and microscopes, criteria on the minimum number of cells to count, and confidence limits.

Further information on this topic is available in articles by Venrick (1978 a, b and c) and by Andersen and Thronsdén (2004). Countries in which accreditation is required have available protocol manuals that are distributed by the national agencies responsible for overseeing the food security and the accreditation of analytical laboratories. For example, the agency legally responsible for developing and disseminating technical standards in Spain is the Asociación Española de Normalización y Acreditación (AENOR, [www.aenor.es](http://www.aenor.es)).

### Controlling the quality of analyses

The heads of monitoring centres should take measures enabling them to control the quality of analyses conducted by the different specialists who work in the same unit, thus ensuring that the results obtained are comparable. This aim is achieved through internal calibration exercises. It is also highly recommended that specialists from each centre participate in national and international **inter-laboratory calibration exercises**, supervised by an authority that is recognized in its field. Intercalibration exercises for quantitative microalgal analyses using the Utermöhl method involve the distribution of aliquots from the same sample to the analysts who carry out the process. Instructions on the standards to be followed (i.e. materials and methods) are provided, and a statistical analysis of the results is conducted.

The ultimate aim of each laboratory is to achieve the lowest possible coefficients of variation (CV), both in analyses repeated by the same person and in comparisons between specialists in the same unit. Once the desired internal quality

has been attained, the next step is to achieve good evaluations through participation in inter-laboratory comparative exercises. If the expected results are not obtained, it will be necessary to identify the sources of error during the analytical process resulting in high variability, or to increase the sample size (number of cells to count), if necessary.

### Interpretation of the results

The ultimate goal of the specialists dedicated to researching and monitoring harmful algal blooms is to develop an early warning system for toxic events and to improve the capacity to predict them.

Data obtained from regular sampling of microalgae and the environmental conditions associated with their occurrence constitute excellent raw material to begin to describe the seasonal and interannual variability of species at a location.

It is **essential** to design an appropriate system for storing the data obtained from analyses. Entering the species counts (and the factors to be applied) into spreadsheets (e.g. EXCEL) greatly facilitates calculations for estimating cellular concentrations; the preparation of graphics showing distribution in time and space, and the use of statistical treatments to infer relationships between the appearance and abundance of species and specific environmental conditions. Similar sheets should also be prepared for recording the measurements of environmental parameters (e.g. temperature, salinity) taken at the same sampling sites.

### References

- Andersen P, Thronsdén J (2004) Estimating cell numbers. In: Hallegraeff GM, Anderson DM, Cembella AD (eds) *Manual on Harmful Marine Microalgae*. Monogr Oceanogr Method 11, UNESCO, Paris, pp 99-130.
- Eder L, Elbrächter M (2010) The Utermöhl method for quantitative phytoplankton analysis. In: Karlson B, Cusack C, Bresnan E (eds) *Microscopic and molecular methods for quantitative phytoplankton analysis*. IOC Manuals and Guides 55, UNESCO, Paris, pp. 13-20.
- Venrick EL (1978a) How many cells to count? In: Sournia A (ed), *Phytoplankton Manual*. Monogr Oceanogr Method 6, UNESCO, Paris, pp 167-180.
- Venrick EL (1978b) The implications of subsampling. In: Sournia A (ed), *Phytoplankton Manual*. Monogr Oceanogr Method 6, UNESCO, Paris, pp 75-87.
- Venrick EL (1978) Sampling design. In: Sournia A (ed), *Phytoplankton manual*. Monogr Oceanogr Method 6, UNESCO, Paris, pp 7-16.
- Villafañe EV, Reid FMH (1995) Métodos de microscopía para la cuantificación del fitoplancton. In: Alveal K, Ferrario ME, Oliveira EC, Sar E (eds), *Manual de Métodos Ficológicos*. Universidad de Concepción, Concepción, Chile, pp 169-185

## 6 Steps for identifying microalgae that cause toxic events

Beatriz Reguera

Instituto Español de Oceanografía, Subida a Radio Faro 50, 36390 Vigo, Spain

One of the key questions in the initial stages of a monitoring programme is identifying, beyond any doubt, the microalgal species responsible for recurring toxic events in the region. Early detection of its presence would be a priority for the monitoring programme. Knowledge of species causing toxic outbreaks in other parts of the world is an indispensable starting point (see the IOC list of toxic species <http://www.marinespecies.org/hab/index.php>). However, given the intra-species variability that can be observed in the content of microalgal toxins (e.g. very toxic strains, slightly toxic strains, and even non-toxic strains within the same species), each region must gather information specific to the (qualitative) profile and (quantitative) toxin content in the problematic species, as well as the ranges of variability in the toxin content per cell throughout the year. Below, we shall review the necessary steps for identifying, beyond any doubt, the species causing a toxic outbreak at a given location. In some cases, the required material means or specialized personnel may not be available to perform all of the steps, but it is important to go as far as possible, and to know how to store fixed phytoplankton samples and frozen toxic material (e.g. filtered or centrifuged hauls of plankton or bivalve flesh) so that pending matters can be resolved through collaboration with other experts as soon as possible.

### Toxin analysis of molluscs (Fig. 1)

In places where no monitoring programme for toxins in molluscs exists, outbreaks of poisoning in people who have eaten phycotoxin-contaminated seafood can occur. In such cases, it is essential to track down the food responsible for the illness and obtain a sample for analysis (e.g. from leftovers kept in the refrigerator). In rare cases, it has been possible to analyse toxins in fluids (e.g. blood, urine) from patients who were treated at a primary healthcare facility (J. Lagomasino, pers. comm.). If, on the other hand, an official toxin-monitoring programme already exists, try in that case to obtain information about the toxins detected in the contaminated product, or secure a sample for analysis.

Chapter 7 presents the steps to be followed for preparing mollusc flesh for toxin analysis. It is essential to come to an agreement with the specialists who will conduct the analysis regarding the practical details of the protocol. Indeed, the procedure extracting toxins from mollusc flesh is different depending on whether the toxins are water-soluble (e.g. paralytic or amnesic toxins) or fat-soluble (e.g. diarrhetic toxins, azaspiracids).

If mouse bioassays are used, the results will indicate the type of toxins present (if the symptoms leading to the mouse's death are identifiable), and their concentration will be expressed in micrograms equivalent to the reference toxin (STX

in the case of paralytic toxins, OA in the case of diarrhetic toxins, etc.) per kg of mollusc flesh (e.g. 820 µg equiv. STX · kg<sup>-1</sup> of mussels). If the analysis is conducted by means of high-performance liquid chromatography (HPLC) or, even better, liquid chromatography–mass spectrometry (LC-MS), you will obtain a **profile of the different toxins in the molluscs** and their concentration. Information about standard mouse assays and chemical analyses for identifying phycotoxins can be consulted in the second edition of the *Manual on Harmful Marine Microalgae* published by IOC-UNESCO (Hallegraeff *et al.* 2003) and in a book about harmful algal blooms in the Southern Cone (Sar *et al.* 2002).

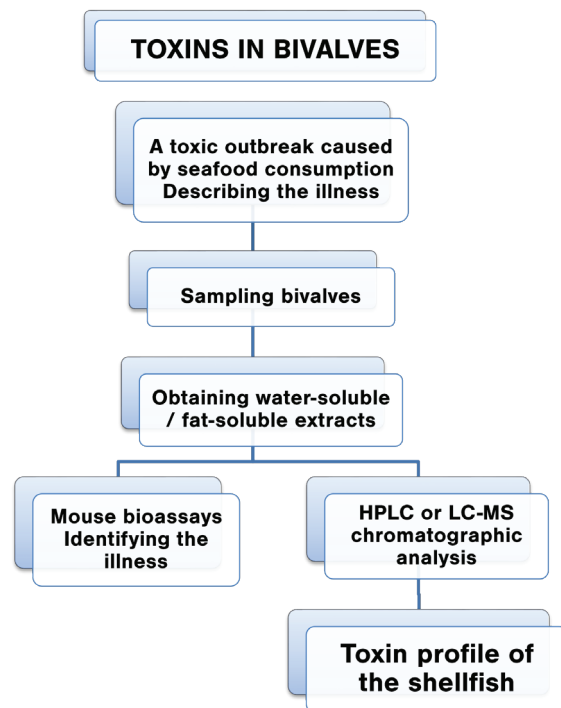

**Figure 1.** Necessary steps for obtaining the toxin profile of molluscs.

### Toxin analysis of plankton (Fig. 2)

Once the contaminated mollusc has been detected, try to ascertain if the toxins come from toxigenic microalgae present in the plankton. The procedures for sampling plankton in the water column and for processing plankton samples for toxin analysis are described in chapters 2 and 4. To identify the suspicious species, it is recommended to do a vertical haul using a plankton net with a mesh size of 10–20 µm. It is essential to transport the haul in good conditions to the laboratory since the preliminary identification of various microalgal groups requires the observation of live (unfixed) cells and their swim-

ming behaviour. Part of this haul will be used to make fixed samples. If the microalgal group (e.g. diatoms, athecate dinoflagellates, small flagellates) to which the problematic species belongs is not even known, it is recommended to fix an aliquot with neutral formalin, another aliquot with an acidic solution of Lugol's iodine, and a third with glutaraldehyde.

It is recommended to use a plankton net that is larger than those used to take samples for species-identification purpose and that has a PVC collection cylinder with a closed bottom. In this way, the filtered material remains suspended in seawater and cell breakage is minimized. If the collected material will be analysed through high-performance liquid chromatography (HPLC), or even better, liquid chromatography–mass spectrometry (LC-MS), simply filter or centrifuge 10–50 ml of the haul (depending on its density). If, however, testing will involve mouse bioassays, a larger biomass of phytoplankton is necessary. If the haul can be “fractionated”, that is, if different size ranges can be selected by means of sieves or filters, you can have more precision in determining in which phytoplankton fraction or size range the toxic organism is found (if any).

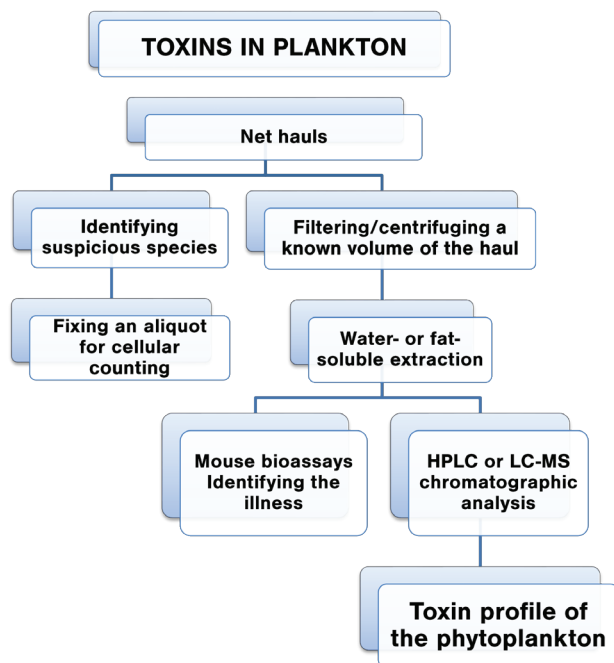

**Figure 2.** Necessary steps for obtaining the toxin profile of concentrated phytoplankton.

If mouse bioassays are used, the results will indicate the type of toxins present (if the symptoms leading to the mouse's death are identifiable), and their concentration will be expressed in micrograms equivalent to the reference toxin (e.g. STX in the case of paralytic toxins, OA in the case of diarrhetic toxins) in relation to the cells (of suspicious species) quantified in the sample (e.g.  $\mu\text{g equiv. OA}/10^6$  cell *Dinophysis*). If the analysis is conducted by means of HPLC or LC-MS, you will obtain a **profile of the different toxins in the plankton** and their concentration in relation to the cells (of suspicious species) quantified in the sample (e.g. 24 pg of OA and 36 pg of PTX2 per cell of *Dinophysis*).

Toxin analysis of the phytoplankton haul will confirm whether the source of toxins observed in the mollusc is found in the plankton. If this is not the case, it must be deduced that the toxicity was caused by an organism that was no longer present in the water column at the time of sampling.

### Toxin analysis of monoalgal cultures (Fig. 3)

Observing a live sample of phytoplankton sometimes allows for immediate recognition of the toxigenic potential of one of the species present (e.g. chains of *Gymnodinium catenatum*, armoured cells of *Alexandrium*). To connect the toxins found in the plankton haul with a specific species, it is necessary to demonstrate the presence of toxins in the species:

- Through isolation using micromanipulation, the establishment of a monoalgal culture and the posterior analysis of a known volume of culture containing an estimated number of cells of the problematic species
- Alternatively, by means of chromatographic analysis of cells isolated through micromanipulation (500–1000 for analysis using HPLC; 50–100 for analysis using LC-MS)

Analysing an extract of a monoalgal culture (or of cells isolated through micromanipulation) enables us to obtain the **toxin profile of the suspicious species** and its toxin content per cell ( $\text{pg} \cdot \text{cell}^{-1}$ ).

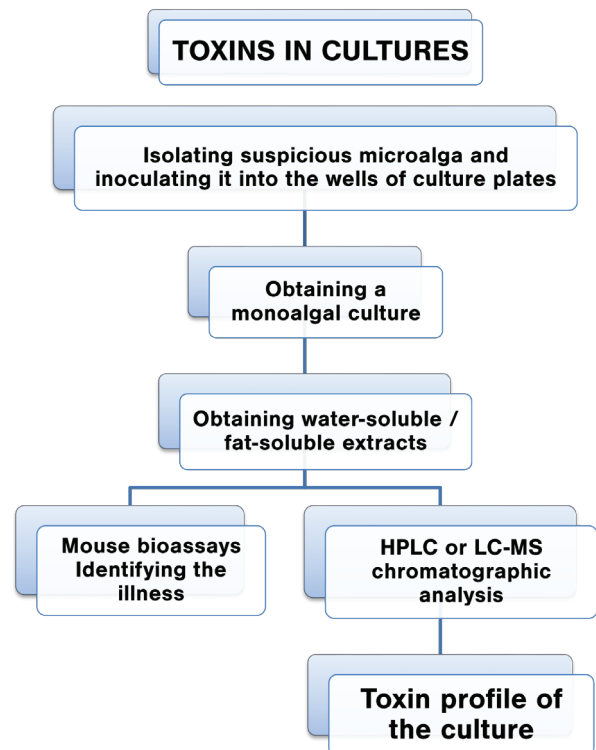

**Figure 3.** Necessary steps for obtaining the toxin profile of a culture.

## Interpretation of the results and a list of common mistakes

After completing the steps outlined in Fig. 1 and Fig. 2 we can establish what types of toxins the contaminated bivalves contain and whether their profile is similar to the one obtained from analysing extracts from plankton net hauls. Once the steps in Fig. 3 have been carried out, and if the analysis of the extract of monoalgal culture (or of cells isolated through micromanipulation) produces a toxin profile comparable to that of the bivalves and plankton haul, **it can be said with scientific rigour that species X is to blame for the presence of toxins X' in bivalves**. On the contrary, if suspicions cannot be proven, we must remain prudent and restrict ourselves to saying that “the presence of toxins X' in bivalves at location Y is associated with the occurrence of species X”.

The toxin profile of the bivalve (X') should be similar to that of the plankton (P), which in turn will be the same as the profile of the cultured species (X). **Important:** consider toxin biotransformations by the bivalve.

Toxin analysis of extracts from net hauls of the total phytoplankton population (or of a size class, e.g. the fraction 77–20 µm) has often been used when it is suspected that the agent responsible for the toxins is a species that cannot be grown by means of standard culturing techniques (e.g. the case of *Dinophysis* spp. which produce diarrhetic toxins). This practice can, however, lead to a series of errors that is difficult to evaluate:

- It is assumed that there is a single potentially toxic species (or genus, if the species cannot be identified) in the multi-species haul. There might have been other heterotrophic/mixotrophic dinoflagellates, or microzooplankton, which fed on the toxic cells, resulting in an overestimation of the toxin content per cell of toxic microalgae. There might also have been lipophilic toxins adhering to the detritus.
- The results of the chromatographic analysis of extracts from net hauls are not as “clean” as those obtained using monoalgal cultures, owing to the matrix effect of the accompanying material. This situation can lead to an underestimation of the toxin content per cell. Moreover, dense hauls are very labile. If the filtering or centrifuging will not be done immediately, the haul should not be too concentrated. It should also be kept in a portable ice box/cooler because many cells can break and release their contents into the environment.

The toxin profile of molluscs will never be identical to the profile of the toxic plankton to which they were exposed, or of the monoalgal culture of the toxic species. It is known that bivalves transform ingested toxins enzymatically, but some species do so very fast and the changes are more intense (Oshima *et al.*, 1990). For example, in the case of lipophilic toxins, mussels and oysters quickly transform pectenotoxin 2 (PTX2) into its seco acid derivative (not diarrhetic), PTX2SA, while scallops are less efficient at this conversion.

### Precautions:

- The species responsible for the toxic event might not be the dominant species in the phytoplankton, but rather a minority species (e.g. DSP events at low concentrations of *Dinophysis* spp. in populations dominated by *Prorocentrum micans* or by diatoms).
- The toxic species may not have been present in the plankton when the sample was taken. The bivalve might have acquired toxicity by filtering previous populations that have now disappeared.
- Be wary of falling into the error of blaming another heterotrophic or mixotrophic dinoflagellate species that fed on the toxic species (e.g. the erroneous identification of the heterotroph *Protoperidinium crassipes* as the source of azaspiracids, which were actually produced by its prey, the diminutive dinoflagellate *Azadinium spinosum*) (Krock *et al.* 2009).

### References

- Hallegraeff GM, Anderson DM, Cembella AD (eds) (2003) Manual on Harmful Marine Microalgae. Monogr. Oceanogr. Method 11. UNESCO, Paris, 793 pp.
- Krock B, Tillmann U, John U, Cembella AD (2009) Characterization of azaspiracids in plankton size-fractions and isolation of an azaspiracid-producing dinoflagellate from the North Sea. *Harmful Algae* 8: 254-263.
- Reguera B (2002) Establecimiento de un programa de seguimiento de microalgas tóxicas. In Sar E, Ferrario M, Reguera B (eds), *Floraciones Algales Nocivas en el Cono Sur Americano*. Inst. Esp. Oceanogr., Madrid, pp 19-55.
- Sar E, Ferrario M, Reguera B (eds) (2002) *Floraciones Algales Nocivas en el Cono Sur Americano*. Inst. Esp. Oceanogr., Madrid, 312 pp.

## 7 Preparing mollusc flesh for toxin analysis

Rosalba Alonso

Universidad Nacional Autónoma de México, Unidad Académica Mazatlán, Av. Joel Montes Camarena s/n, Col. Playa Sur, Mazatlán, 82040 Sinaloa, México (rosalba@ola.icmyl.unam.mx)

### Extracting soft tissue from organisms for phycotoxin analysis

For the monitoring of marine toxins, bivalve mollusc specimens (e.g. mussels, oysters, clams) are preferably used. In the case of a toxic event, depending on the type of toxin, molluscs, fish, crustaceans or any other group of organism that has shown the effects of toxins (e.g. octopus) can be gathered. The organisms are collected at one or more sampling sites. In the laboratory, wash shells using a brush with plastic bristles, removing other organisms attached to the surface, and rinse off with tap water. In order to have population size-class samples, the organisms are classified by species and divided into groups of larger and smaller sizes (Fig. 1). Next, measure the dimensions (e.g. length, width and thickness) of each organism, recording the data in the log book.

Soft tissue is extracted with the help of stainless steel knives and some regional tools that can break the mollusc shells or dissect organs depending on the case. It is recommended to keep three sets of shells in the case of bivalve molluscs for identification purposes. In the case of fish or crustaceans, keep three specimens in a 10% formalin solution so that their identification can be confirmed by specialists.

After extracting the tissue of the first organism, place it in a clean container or airtight bag and record the individual weight in the log book. As when obtaining the wet weight for each organism, remove any shell residue from the tissue using a squeeze bottle with deionized water (Milli-Q) and remove the excess water with a Pasteur pipette (Fig. 2).

### Homogenizing and freeze-drying oyster tissue

Homogenize the samples and store one of the aliquots in the freezer at a temperature below  $-20^{\circ}\text{C}$ , and if possible between  $-40^{\circ}\text{C}$  and  $-70^{\circ}\text{C}$ . Analyses for paralytic and amnesic toxins are conducted preferably on fresh-frozen tissue. Care must be taken in the case of amnesic toxins to keep the samples frozen and away from light since domoic acid is rapidly degraded.

As regards conserving the samples, it is recommended to freeze-dry (i.e. lyophilize) the tissues for greater safety, especially in areas where power outages are common. Indeed, there is less deterioration of materials and toxins in freeze-dried tissue than in fresh tissue.

After being frozen for 72 h, the sample is placed inside the freeze-dryer (or lyophilizer) with no lid on the container. In the case of a bag, it is left completely open so that the humidity in the sample can be properly extracted. Fit the top on the freeze-dryer, making sure that it is hermetically closed and vacuum sealed. The samples are left for 72 h at  $0.04\text{--}0.06$  mbar and at  $-42^{\circ}\text{C}$ . Then take out the freeze-dried samples, place the corresponding caps on each batch and record the dry weight in the laboratory log-book. The fresh or freeze-dried aliquot is kept frozen (between  $-5^{\circ}\text{C}$  and  $-20^{\circ}\text{C}$ ) until the time for grinding (Fig. 3).



Figure 1. Grouping the organisms by size.

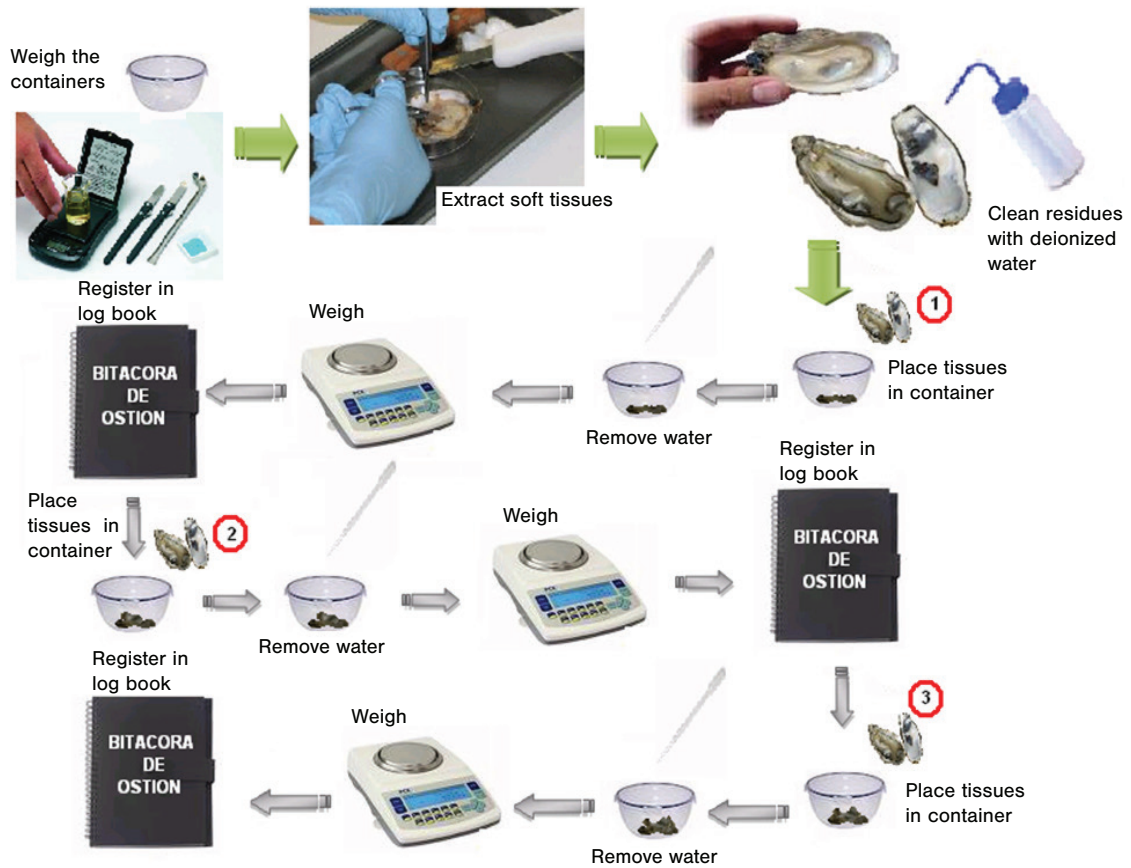

Figure 2. Procedure for extracting the tissue and recording the weight.

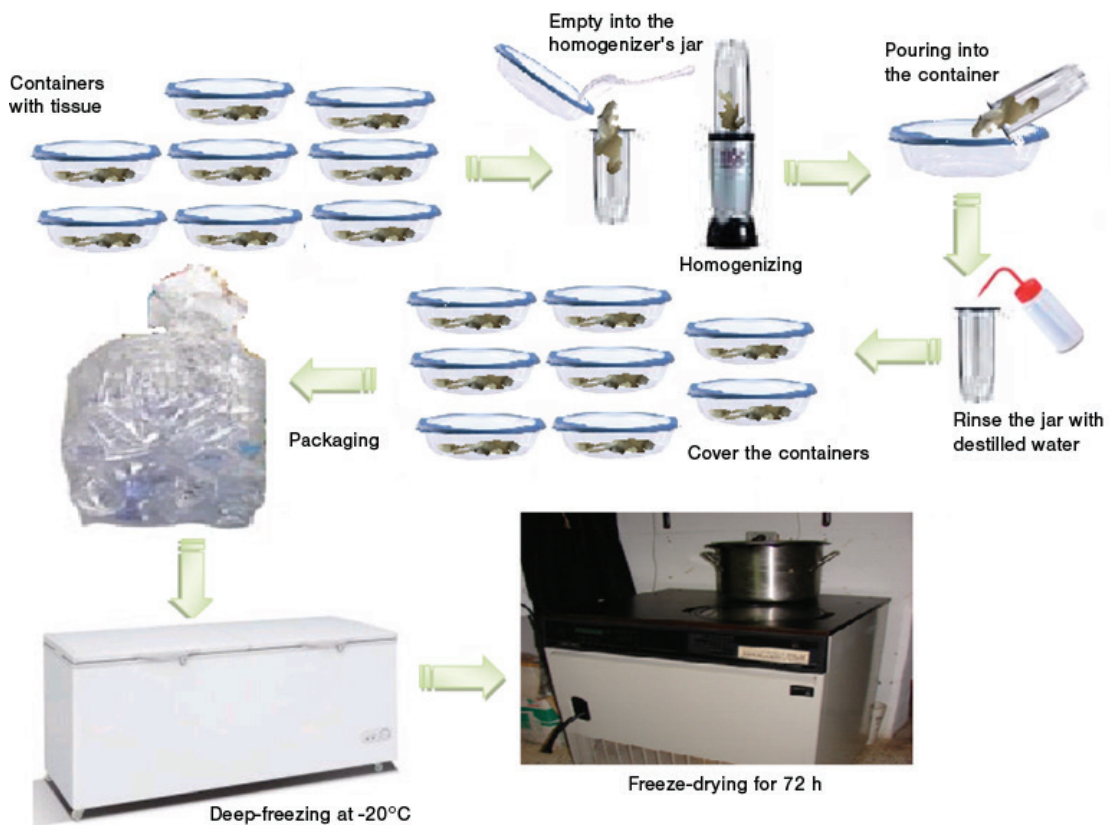

Figure 3. Procedure for liquefying and freeze-drying the tissue.

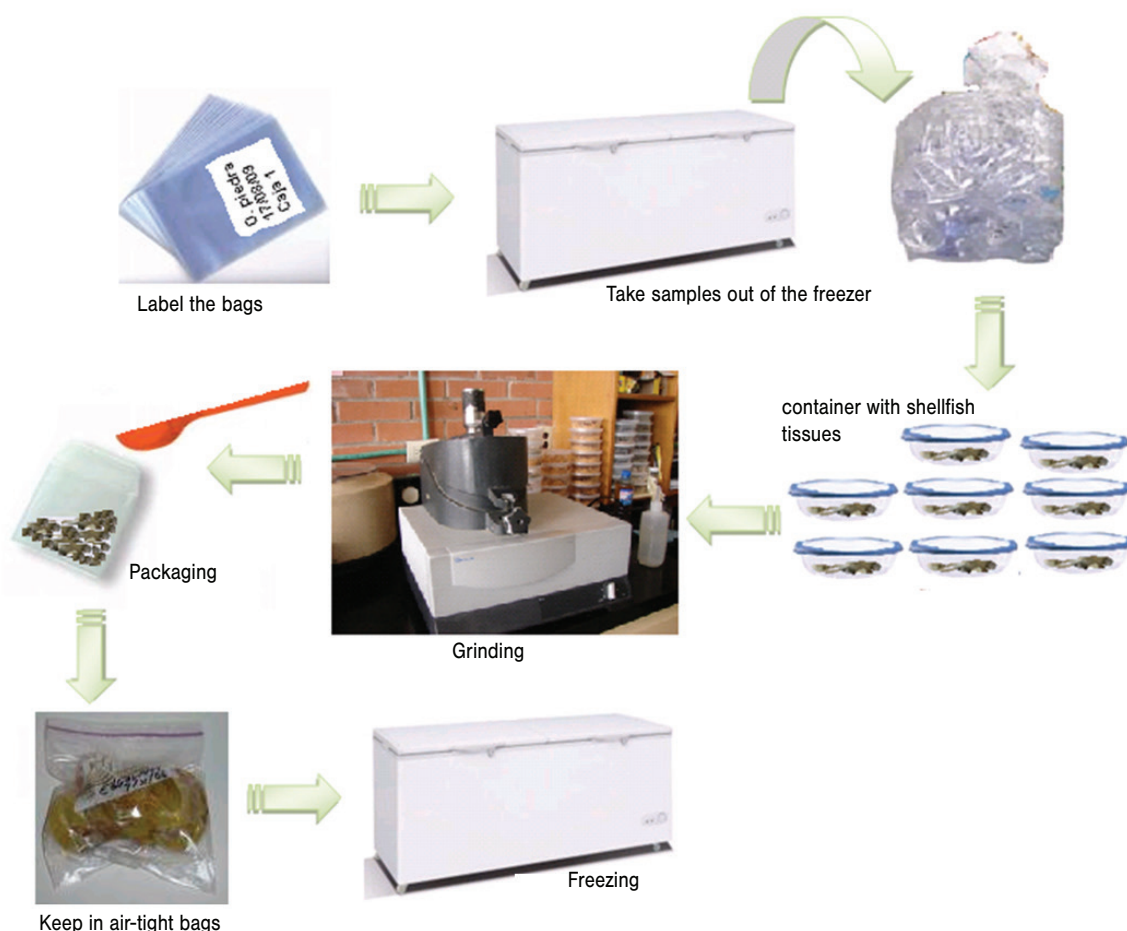

Figure 4. Procedure for grinding the tissue.

### Grinding, packaging and sealing the freeze-dried tissue

The freeze-dried sample is ground by means of an electric grinder or a manual mortar and pestle made of agate or Teflon. This step is very delicate because if the grinder raises the temperature of the sample, the toxins contained in it might volatilize. The temperature of the grinder must therefore be monitored. If the grinder begins to get warm, interrupt the process and wait from 30 to 40 min for it to cool off (Fig. 4).

To package the samples, use small polythene bags previously labelled with the corresponding information for each sample.

The samples are sealed by means of an iron or electric bag-sealer in which, depending on the size, four bags can fit simultaneously. Make sure that the bags are separate from one another since the heat could fuse together two different bags. Ironing is done quickly and gently to avoid burning the sample bag. Once the process is finished, the samples are placed in hermetically sealed bags labelled with information about the sampling and are kept frozen at a temperature between  $-4^{\circ}\text{C}$  and  $-20^{\circ}\text{C}$  until their analysis. If the samples are to be used for amnesic toxin analysis, keep them away from light.

For toxin analysis using HPLC or LC-MS, official methods require small amounts of fresh-frozen tissue for extraction: 5

g of fresh tissue for paralytic shellfish toxin analysis (AOAC 2005.06; Lawrence *et al.* 2005) and 10 g for amnesic shellfish toxin analysis (Quilliam 2003), or the equivalent in freeze-dried tissue:

$$5 \text{ g dry weight aliquot} = 5 \times (\text{dry weight/wet weight}) \text{ g}$$

$$10 \text{ g dry weight aliquot} = 10 \times (\text{dry weight/wet weight}) \text{ g}$$

### References

- Anonymous (2005) AOAC Official Method 2005.06: quantitative determination of paralytic shellfish poisoning toxins in shellfish using pre-chromatographic oxidation and liquid chromatography with fluorescence detection. Gaithersburg, MD: AOAC International, 13 pp.
- Lawrence JF, Niedzwiedek B, Menard C (2005) Quantitative determination of paralytic shellfish poisoning toxins in shellfish using pre-chromatographic oxidation and liquid chromatography with fluorescence detection: collaborative study. J. AOAC Int 88: 1714-1732.
- Quilliam AM (2003) Chemical methods for domoic acid, the amnesic shellfish poisoning (ASP) toxin. In: Hallegraeff GM, Anderson DM, Cembella AD (eds) Manual on Harmful Marine Microalgae, Monogr. Oceanogr. Method 11, UNESCO, Paris, pp 247-266.



## 8 Practical sampling guidance for determination of ciguatoxin in fish

Rachel J. Clausing<sup>1</sup>, Mireille Chinain<sup>2</sup> and Marie-Yasmine Dechraoui Bottein<sup>1</sup>

<sup>1</sup>International Atomic Energy Agency, Environment Laboratories, 4a Quai Antoine 1<sup>er</sup>, MC 98000 Monaco

<sup>2</sup>Institut Louis Malardé, Rue du 5 Mars 1797, 98713 Papeete, French Polynesia

### Introduction

Ciguatera fish poisoning (CFP) is a seafood-borne illness caused by consumption of tropical and subtropical fish that have accumulated ciguatoxins (CTXs) in their tissues. Ciguatoxins are lipid-soluble polyether, polycyclic molecules produced by species of *Gambierdiscus*, a genus of benthic microalgae that is distributed throughout tropical and subtropical marine waters globally. Ciguatoxin profiles may differ widely among *Gambierdiscus* species (Roeder *et al.* 2010). As herbivorous fish ingest *Gambierdiscus* spp., the ciguatoxins they contain (e.g. CTX-3C and CTX-4B/A; Chinain *et al.* 2010a) are distributed to various fish tissues (O'Toole *et al.* 2012, Ledreux *et al.* 2014), where physiological processes can result in their bioaccumulation and biotransformation into different congeners with varying toxicity (reviewed by Lewis and Holmes 1993, Lehane and Lewis 2000). This process of bioaccumulation and biotransformation continues up the food chain leading to even greater toxin variability in top fish predators (e.g. moray eels or barracuda) (Dickey and Plakas 2010, Yogi *et al.* 2011). In general, the dominant forms of CTX are less oxidized in lower trophic levels (e.g. P-CTX-3C, 4A, and 4B in the Pacific) and both more oxidized (e.g. P-CTX-1) (e.g. Darius *et al.* 2007, Mak *et al.* 2013) and more potent (Dechraoui *et al.* 1999, Yogi *et al.* 2011) in higher trophic levels (Table 1). Structures of dominant Pacific and Caribbean ciguatoxins are shown in Fig. 1.

Because the more toxic congeners of CTX are generally found higher in the food chain (e.g. Mak *et al.* 2013), large predatory fish such as barracuda (*Sphyraena* spp.) are most likely to induce CFP (Dechraoui *et al.* 2005, Darius *et al.* 2007, Clua *et al.* 2011). Large demersals like snappers (*Lutjanus* spp.) are also considered high-risk, and serranids such as the coral trout have been cited in cases of CFP throughout the Pacific (New Caledonia: Clua *et al.* 2011; Hong Kong: Wong *et al.* 2014; Japan: Oshiro *et al.* 2010; French Polynesia: reviewed by Darius *et al.* 2007; Hawaii: Dierking and Campora 2009). In the Caribbean, recent evidence that lionfish (*Pterois* spp.) can attain toxic levels of CTXs (Robertson *et al.* 2014) has prompted concern about strategies to contain the growing populations of these invasive fish by promoting their consumption (Soliño *et al.* 2015). Though their toxicity is generally assumed to be lower, herbivorous reef fish (e.g. scaridae and acanthuridae) can also be agents of CFP. In fact, the acanthurid *Ctenochaetus striatus* is often considered a good indicator species of CFP risk (Rongo and van Woesik 2013) as well as a primary vector for trophic transfer of CTX (Lewis *et al.* 1994, Rongo and van Woesik 2011). Moreover, in French Polynesia, recent large-scale surveys indicated that smaller, herbivorous acanthurids were among the most toxic in terms of both mean concentration of CTX per gram fish flesh (<0.37 ng equiv. P-CTX-3C

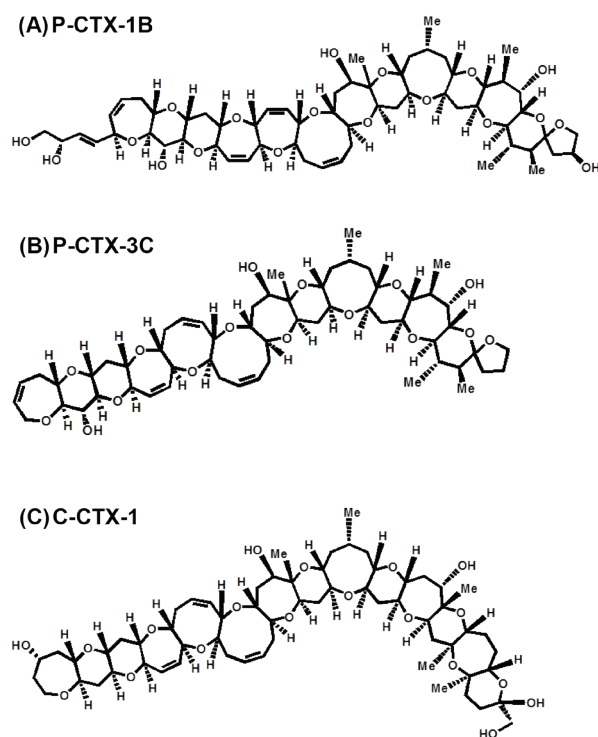

**Figure 1.** Structure of (A) a type 1 Pacific ciguatoxin (P-CTX-1B; Murata *et al.* 1990), (B) a type 2 Pacific ciguatoxin (P-CTX-3C; Satake *et al.* 1993) and (C) Caribbean ciguatoxin (C-CTX-1; Lewis *et al.* 1998)

g<sup>-1</sup>) and proportion of fish toxic to humans (Gaboriau *et al.* 2014). Lists of high-risk fish species for ciguatoxicity from selected countries in the Caribbean and tropical Pacific and Indian Oceans are given in Table 2.

Within a given trophic level, ciguatoxicity of a species may depend on a number of factors that can cause regional and even local (<10 km) differences among species (Fig. 2; Darius *et al.* 2007, Chinain *et al.* 2010b). Trophic transfer of toxins depends on the cell density of a *Gambierdiscus* sp. on the host macrophyte, the toxicity of the cells (>100 fold variation among species: Chinain *et al.* 2010a, Litaker *et al.* 2010), and the palatability of the macroalgal host (Cruz-Rivera and Villareal 2006). Thus, the macroalgal host-*Gambierdiscus* association (Parsons *et al.* 2011) determines if cell production translates into toxicity up the food chain (Cruz-Rivera and Villareal 2006, Rains and Parsons 2015). Accordingly, combining experimental or published data on *Gambierdiscus* spp. toxicity and host preferences with host palatability data may be useful for identifying probable sources of CTX into the

## Chapter 8 Practical sampling guidance for determination of Ciguatoxin in fish

**Table 1.** Ciguatoxin congeners and the trophic level of the organisms in which they are generally found. Adapted from Caillaud et al. 2010 and the EFSA 2010. LD50 indicates the mean lethal dose (intraperitoneal) in mice in µg/kg body weight. TEF is the toxicity equivalency factor expressed as P-CTX-1 equivalents as determined by the EFSA Panel.

Toxin	Alternative name	Trophic level	LD50/TEF		References
Pacific ciguatoxins (P-CTXs)					
P-CTX-1	CTX-1B	carnivorous fish	0.25	1	(Lewis et al. 1991, Lewis and Jones 1997)
P-CTX-2	CTX-2A2; 52-epi-52-deoxyCTX	carnivorous fish	0.9	0.3	(Lewis et al. 1991, 1993, Lewis and Jones 1997)
P-CTX-3	CTX-2B2; 54- deoxyCTX	carnivorous fish	0.9	0.3	(Lewis et al. 1991, Lewis and Jones 1997)
P-CTX-3B	49-epi-CTX-3C	<i>Gambierdiscus</i> spp.			(Satake et al. 1993, Chinain et al. 2010a)
P-CTX-3C		<i>Gambierdiscus</i> spp./ herbivorous fish carnivorous fish	2	0.2	(Satake et al. 1993, Roeder et al. 2010)
P-CTX-4A	52-epi-ciguatoxin-4B	<i>Gambierdiscus</i> spp.	2	0.1	(Murata et al. 1990, Yasumoto et al. 2000, Roeder et al. 2010)
P-CTX-4B	GT-4B	<i>Gambierdiscus</i> spp./ herbivorous fish	4	.05	(Satake et al. 1996, Yasumoto et al. 2000, Roeder et al. 2010)
M-seco-CTX-3C		<i>Gambierdiscus</i> spp.			(Satake et al. 1993, Chinain et al. 2010a)
CTX-2A1	2,3-dihydroxyCTX-3C	carnivorous fish/ <i>Gambierdiscus</i> spp.	1.8	0.1	(Satake et al. 1998, Roeder et al. 2010)
CTX-2C1	51-hydroxyCTX-3C	carnivorous fish	0.27		(Satake et al. 1998)
Caribbean ciguatoxins (C-CTXs)					
C-CTX-1		carnivorous fish	3.6	0.1	(Vernoux and Lewis 1997, Lewis et al. 1998, 1999, Pottier et al. 2002a, 2002b, 2003)
C-CTX-2	56-epi-C-CTX-1	carnivorous fish	1	0.3	(Vernoux and Lewis 1997, Lewis et al. 1998, Pottier et al. 2002a, 2002b, 2003)
C-CTX-1127		carnivorous fish			(Pottier et al. 2002a, 2002b, 2003)
C-CTX-1143		carnivorous fish			(Pottier et al. 2002a, 2002b, 2003)
C-CTX-1157		carnivorous fish			(Pottier et al. 2002a, 2002b, 2003)
C-CTX-1159		carnivorous fish			(Pottier et al. 2002a, 2002b, 2003)
Indian Ocean ciguatoxins (I-CTXs)					
I-CTX-1		carnivorous fish	~0.5	0.5	(Hamilton et al. 2002a,b)
I-CTX-2		carnivorous fish	~0.5	0.5	(Hamilton et al. 2002a, b)
I-CTX-3		carnivorous fish			(Hamilton et al. 2002a,b)
I-CTX-4		carnivorous fish			(Hamilton et al. 2002a,b)

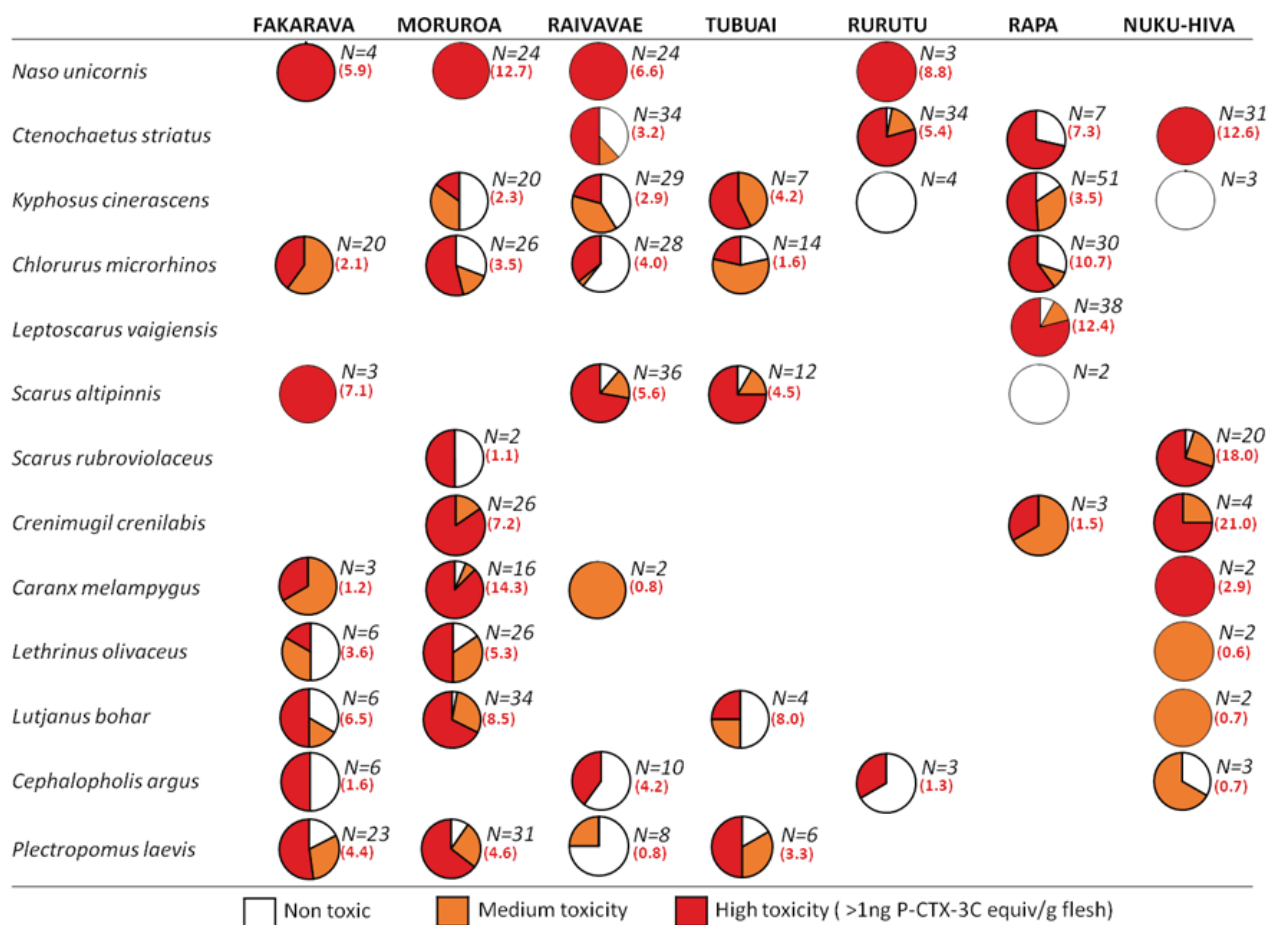

**Figure 2.** Spatial differences in proportions of toxic specimens from at-risk fish species sampled at various locations within French Polynesia. White is non-toxic fish, orange is medium toxic, while red indicates highly toxic fish (> 1 ng P-CTX-3C equiv./g flesh). For each fish species and island, (N) is the total number of specimens analyzed. The maximum toxicity value recorded using the Receptor Binding Assay is also given in brackets. This figure illustrates how variable toxicity can be in a given species at the regional scale.

food web (Cruz-Rivera and Villareal 2006). **Thus, both research and local knowledge are essential to determine the likely vectors of CTX transmission into the food chain and resulting appropriate target species for sampling.**

Fish age and size may also affect toxicity within a species. Conventional knowledge suggests that larger individuals are likely to have greater tissue CTX concentrations simply because of a longer lifespan over which to consume and accumulate toxin (Lewis and Holmes 1993, Lehane and Lewis 2000). Accordingly, many countries impose size restrictions for consumption of risky fish species in an effort to prevent CFP (reviewed by Yang *et al.* 2016). In Hawaii, for example, the market sale of great amberjacks is prohibited for individuals larger than 9 kg (details in Clua *et al.* 2011). In Australia, regulation may be imposed by the market, where some restaurant limit purchase of coral grouper to less than 2.5 kg (Lehane and Lewis 2000). Yet in other countries, entire species are banned (e.g. French Polynesia; Table 2). New Caledonia has prohibited market sale of the most toxic species, including three species of snapper (*Lutjanus bohar*, *L. monostigma* and *L. rivulatus*), moray eel (*Gymnothorax javanicus*) and peacock grouper (*Cephalopholis argus*) (Clua *et al.* 2011).

Size may not be a reliable proxy for relative toxicity, however. Although some research has found a positive relationship of size (length or weight) and toxicity in species of *Caranx*, grouper (Dierking and Campora 2009), snapper (Oshiro *et al.* 2010) and moray eels (Mak *et al.* 2013), other studies on the same as well as other genera have found no such relationship (Lewis *et al.* 1992, Dechraoui *et al.* 2005, Darius *et al.* 2007, O’Toole *et al.* 2012, Gaboriau *et al.* 2014). Tissue CTX concentrations depend on species-specific rates of toxin assimilation and excretion (Tosteson *et al.* 1988, Lewis *et al.* 1992, Ledreux *et al.* 2014), as well as growth (reviewed by Yang *et al.* 2016). Thus, while size remains an important consideration for sampling, fish age, which can have a tenuous relationship with size, may be a better indicator of toxic potential.

This protocol proposes a methodology for fish sampling and processing for ciguatera risk assessment. It provides recommendations for sampling strategies depending on the specific goals of the assessment.

**Table 2.** Examples of lists of high-risk ciguatoxic fish species from countries in each of the major tropical oceans.

**A. PACIFIC**

**French Polynesia**

*High-risk species*

TL	Scientific name	Common name	Local name	Family
H(1)	<i>Ctenochaetus striatus</i>	striated surgeonfish	maito	Acanthuridae
H	<i>Naso unicornis</i>	brown unicornfish	maito	Acanthuridae
H	<i>Scarus altipinnis</i>	filament-finned parrotfish	uhu'opara	Scaridae
H	<i>Chlorurus microrhinos</i>	steephead parrotfish	uhu raepu'u	Scaridae
H	<i>Crenimugil crenilabis</i>	fringelip mullet	tehu	Mugilidae
H	<i>Liza vaigiensis</i>	squaretail mullet		Mugilidae
C(2)	<i>Cephalopholis argus</i>	bluespotted grouper	roi	Serranidae
C	<i>Epinephelus polyphkadion</i>	marbled grouper	hapu'u	Serranidae
C	<i>Plectropomus laevis</i>	blacksaddle coral grouper	tonu	Serranidae
C	<i>Lutjanus bohar</i>	two-spot red snapper	ha'amea	Lutjanidae
C	<i>Lutjanus gibbus</i>	paddletail snapper	taea	Lutjanidae
C	<i>Lutjanus monostigma</i>	blackspot snapper	taivaiva	Lutjanidae
C	<i>Caranx melampygus</i>	bluefin jack	pa'aihere	Carangidae
C	<i>Lethrinus olivaceus</i>	longnose emperor	o'eo	Lethrinidae
C	<i>Sphyaena barracuda</i>	great barracuda	ono	Sphyaenidae
C	<i>Balistoides viridescens</i>	titan triggerfish	o'iri	Balistidae

Source: Darius et al 2007; Gaboriau et al. 2014; www.ciguatera-online.com

*Banned species (illegal to sell):*

TL	Scientific name	Common name	Local name	Family
H	<i>Ctenochaetus striatus</i>	striated surgeonfish	maito	Acanthuridae
C	<i>Epinephelus polyphkadion</i>	marbled grouper	hapu'u	Serranidae
C	<i>Epinephelus tauvina</i>	greasy grouper	faroa	Serranidae
C	<i>Plectropomus laevis</i>	blacksaddle coral grouper	tonu	Serranidae
C	<i>Lutjanus bohar</i>	two-spot red snapper	haamea	Lutjanidae
C	<i>Lutjanus gibbus</i>	paddletail snapper	tuhara	Lutjanidae
C	<i>Lutjanus rivulatus</i>	maori snapper	haputu	Lutjanidae
C	<i>Lutjanus monostigma</i>	blackspot snapper	taivaiva	Lutjanidae
C	<i>Cheilinus undulatus</i>	humphead wrasse	mara	Labridae
C	<i>Lethrinus olivaceus</i>	longnose emperor	o'eo	Lethrinidae
C	<i>Sphyaena barracuda</i>	great barracuda	ono	Sphyaenidae
C	<i>Ruvettus pretiosus</i>	oilfish	uravena	Gempylidae
C	All species	pufferfish	huehue	Tetraodontidae

(1) Indicates herbivorous species; (2) Indicates carnivorous species

Source: Commune de Papeete. Conseil Municipal 1939. Session ordinaire de novembre 1939, 1ère séance 8 Novembre. Arrêté municipal relatif à l'interdiction de la vente de certaines espèces dangereuses de poissons, p.148-149

**New Caledonia**

Scientific name	Common name	Local name	Family	Risk
<i>Cephalopholis argus</i>	bluespotted grouper	loche paon	Serranidae	(1)
<i>Cephalopholis miniata</i>	coral hind	loche sanguine	Serranidae	(2), 25
<i>Plectropomus laevis</i>	blacksaddle coral grouper	saumonée à gros points	Serranidae	(1), 75
<i>Epinephelus tauvina</i>	greasy grouper	loche mouchetée	Serranidae	(2), 35
<i>Epinephelus fuscoguttatus</i>	brown-marbled grouper	loche marbrée	Serranidae	(2), 40
<i>Epinephelus polyphkadion</i>	marbled grouper	loche crasseuse	Serranidae	(2), 35
<i>Variola louti</i>	yellow-edged lyretail	saumonée hirondelle	Serranidae	(2), 35
<i>Lutjanus bohar</i>	two-spot red snapper	anglais	Lutjanidae	(1)
<i>Lutjanus monostigma</i>	blackspot snapper	lutjan à point noir	Lutjanidae	(1)
<i>Lutjanus rivulatus</i>	maori snapper	perche maori	Lutjanidae	(1)
<i>Lutjanus fulviflamma</i>	dory snapper	vivaneau jaune	Lutjanidae	(2), 25
<i>Lutjanus gibbus</i>	paddletail snapper	lutjan à queue en pagaie	Lutjanidae	(2), 30
<i>Aprion virescens</i>	green jobfish	mékoua	Lutjanidae	(2), 65
<i>Symphorus nematophorus</i>	chinamanfish	barbillon	Lutjanidae	(1), 60
<i>Caranx ignobilis</i>	giant trevally	carangue baoum	Carangidae	(1), 55
<i>Caranx lugubris</i>	black jack	carange noire	Carangidae	(2), 40
<i>Lethrinus miniatus</i>	trumpet emperor	gueule rouge	Lethrinidae	(1), 30
<i>Lethrinus xanthochilus</i>	yellowlip emperor	bec de cane à lèvres jaunes	Lethrinidae	(2), 30
<i>Sphyaena</i> spp.	barracuda	bécunes et barracuda	Sphyaenidae	(2), 60
<i>Gymnothorax javanicus</i>	giant moray	murène géante	Muraenidae	(1)
<i>Bodianus perditio</i>		perroquet-banane	Labridae	(2), 40
<i>Scomberomorus commerson</i>	narrow-barred spanish mackerel	thazard du lagon	Scombridae	(2), 90

(1) High ciguatoxin risk; (2) medium risk; following #'s indicate weight restriction in cm

Source: Clua et al. 2011

**Kiribati**

Scientific name	Common name	Local name	Family
<i>Acanthurus lineatus</i>	lined surgeonfish	riba tanin	Acanthuridae
<i>Ctenochaetus striatus</i>	striated surgeonfish	riba roro	Acanthuridae
<i>Scarus oviceps</i>	dark capped parrotfish	ika maawa	Scaridae
<i>Epinephelus lanceolatus</i>	giant grouper	bakati	Serranidae
<i>Epinephelus fuscoguttatus</i>	brown-marbled grouper	maneku	Serranidae
<i>Epinephelus polyphekadion</i>	marbled grouper		Serranidae
<i>Cephalopholis argus</i>	peacock hind	nimanang	Serranidae
<i>Lutjanus bohar</i>	two-spot red snapper		Lutjanidae
<i>Lutjanus monostigma</i>	blackspot snapper	tinaemea	Lutjanidae
<i>Lutjanus fulvus</i>	blacktail snapper	bawe	Lutjanidae
<i>Sphyaena</i> spp.	barracuda	nunua	Sphyaenidae
<i>Gymnothorax</i> spp.	moray eels		Muraenidae
All species	triggerfish	bourse/baliste	Balistidae

Source: Mak et al. 2013; Laurent et al. 2005

**B. CARIBBEAN**

**Cuba**

Scientific name	Common name	Local name	Family	
<i>Mycteroperca bonaci</i>	black grouper	aguaji o bonaci arará	Serranidae	(1)
<i>Mycteroperca tigris</i>	tiger grouper	bonaci gato	Serranidae	(3)
<i>Mycteroperca venenosa</i>	yellowfin grouper	arigua, bonaci cardinal/de piedra	Serranidae	(2)
<i>Lutjanus cyanopterus</i>	cubera snapper	cubera	Lutjanidae	(5)
<i>Lutjanus jocu</i>	dog snapper	pargo jocú	Lutjanidae	(4)
<i>Caranx latus</i>	horse-eye jack	gallego o jurel de plataforma	Carangidae	(6)
<i>Caranx lugubris</i>	black jack	tiñosa o tiñosa prieta	Carangidae	(3)
<i>Carangoides bartholomaei</i>	yellow jack	cibí amarillo	Carangidae	(4)
<i>Seriola dumerili</i>	greater amberjack	coronado de ley	Carangidae	(3)
<i>Seriola rivoliana</i>	longfin yellowtail	coronado	Carangidae	(3)
<i>Seriola zonata</i>	banded rudderfish	coronado de bandas	Carangidae	(3)
<i>Gymnothorax funebris</i>	green moray	morena verde	Muraenidae	(3)
<i>Sphyaena barracuda</i>	great barracuda	picúa o picuda	Sphyaenidae	(3)

(#) indicate restricted weight (1) > 4.5 kg; (2) > 4.6 kg; (3) any weight (4) >1.4 kg; (5) >6.8 kg; (6) > 1 kg

Source: Ministerio de la Industria Pesquera 1996. Resolución No. 457/96 (Anonymous 1996).

**St. Thomas (US Virgin Islands)**

Scientific name	Common name	Family	Risk
<i>Epinephelus adscensionis</i>	rock hind	Serranidae	(2)
<i>Epinephelus morio</i>	red gropuer	Serranidae	(2)
<i>Mycteroperca venenosa</i>	yellowfin grouper	Serranidae	(2)
<i>Lutjanus apodus</i>	schoolmaster	Lutjanidae	(2)
<i>Lutjanus buccanella</i>	blackfin snapper	Lutjanidae	(2)
<i>Lutjanus jocu</i>	dog snapper	Lutjanidae	(1)
<i>Lutjanus mahogoni</i>	mahogany snapper	Lutjanidae	(2)
<i>Seriola dumerili</i>	greater amberjack	Carangidae	(1)
<i>Caranx latus</i>	horse-eye jack	Carangidae	(1)
<i>Caranx lugubris</i>	black jack	Carangidae	(1)
<i>Caranx ruber</i>	bar jack	Carangidae	(1)
<i>Sphyaena barracuda</i>	great barracuda	Sphyaenidae	(1)
<i>Gymnothorax funebris</i>	green moray	Muraenidae	(2)
<i>Balistes vetula</i>	queen triggerfish	Balistidae	(2)
<i>Bodianus rufus</i>	spanish hogfish	Labridae	(2)
<i>Scomberomorus cavalla</i>	kingfish	Scombridae	(2)

(1): high-risk; (2): causes frequent poisoning

Source: Olsen et al. 1984

**Guadeloupe**

Scientific name	Common name	Local name	Family	
<i>Mycteroperca venenosa</i>	yellow fish grouper	vieille à carreaux	Serranidae	(2)
<i>Mycteroperca tigris</i>	tiger grouper	vieille morue	Serranidae	(2)
<i>Alphestes afer</i>	mutton hamlet	vieille varech	Serranidae	(2)
<i>Epinephelus morio</i>	red grouper	vieille blanche	Serranidae	(2)
<i>Lutjanus jocu</i>	dog snapper	pagre dents de chien	Lutjanidae	(2,3)
<i>Lutjanus buccanella</i>	blackfin snapper	vivaneau oreilles noires	Lutjanidae	(3)
<i>Lutjanus apodus</i>	schoolmaster snapper	pagre jaune	Lutjanidae	(3)
<i>Caranx batholomaei</i>	yellow jack	carangue jaune	Carangidae	(1)
<i>Seriola dumerili</i>	greater amberjack	grande sériole	Carangidae	(1)
<i>Seriola rivoliana</i>	almaco jack	sériole limon - babiane	Carangidae	(1)
<i>Caranx lugubris</i>	black jack	carangue noire	Carangidae	(2)
<i>Caranx ruber</i>	bar jack	carangue franche/bleue	Carangidae	(2)
<i>Caranx latus</i>	horse eye jack	carangue gros-yeux mayol	Carangidae	(2)
<i>Sphyaena barracuda</i>	great barracuda	barracuda/bécune	Sphyaenidae	(1)
<i>Gymnothorax funebris</i>	green moray	murène congre vert	Muraenidae	(2)
All species	porcupinefish	poisson porc-épic	Diodontidae	(1)
All species	pufferfish	poisson ballon	Tetraodontidae	(1)

(1) The fishing and sale of these species is prohibited year-round at all locations

(2) For these species, catch and sale is prohibited north of 16°50' latitude

(3) These species cannot be sold if the weight of the fish is greater than 1 kg

Source: Arrêté Préfectoral de la Guadeloupe n°2002/1249 (Anonymous 2002)

**C. INDIAN**

**Reunion Island (1)**

Scientific name	Common name	Local name	Family	
All species	surgeonfish	poisson chirurgien	Acanthuridae	
<i>Variola louti</i>	yellow-edged lyretail	grand queue	Serranidae	(2)
<i>Plectropomus maculatus</i>	coral grouper	babonne	Serranidae	
<i>Lutjanus bohar</i>	two-spot red snapper	vara vara	Lutjanidae	
<i>Lutjanus sebae</i>	emperor red snapper	bourgeois	Lutjanidae	
<i>Sphyaena barracuda</i>	great barracuda	békine à dents	Sphyaenidae	
All species	triggerfish	bourse/baliste	Balistidae	
All species	porcupinefish	poisson porc-épic	Diodontidae	
All species	cow shark	requin grisot	Hexanchidae	
<i>Pterois, Synacncea</i> spp.	scorpion fish	poisson scorpion	Scorpaenidae	
All species	hammerhead/bonnethead sharks	requin marteau	Sphyrnidae	
All species	pufferfish	poisson ballon	Tetraodontidae	

(1) These species are prohibited for commercial sale from any tropical region. An additional list is available of prohibited species that, if locally-caught in Reunion, can be sold

(2) Allowed if <2.5 kg

Source: Arrêté Préfectoral de la Reunion° 2009/SG/DRCTCV (Anonymous 2009)

**Mauritius**

Scientific name	Common name	Local name	Family	
<i>Variola louti</i>	yellow-edged lyretail	yellow-tailed croissant	Serranidae	(1)
<i>Plectropomus maculatus</i>	spotted coralgrouper	sinsillac/vieille babonne	Serranidae	(2)
<i>Cephalopholis argus</i>	peacock hind	crabe noir/vieille cuisinier	Serranidae	
<i>Epinephelus areolatus</i>	areolate grouper	bambara/vieille plate	Serranidae	
<i>Epinephelus fuscoguttatus</i>	brown-marbled grouper	vieille loutre	Serranidae	
<i>Anyperodon leucogrammicus</i>	slender grouper	cheval de bois	Serranidae	
<i>Lutjanus sebae</i>	emperor red snapper	bourgeois	Lutjanidae	(3)
<i>Lutjanus bohar</i>	two-spot red snapper	vara-vara	Lutjanidae	
<i>Lutjanus monostigma</i>	blackspot snapper	giblot	Lutjanidae	
<i>Lutjanus gibbus</i>	paddletail snapper	chemise	Lutjanidae	
<i>Caranx</i> spp.	jacks/trevallies	carangue	Carangidae	(4)
<i>Sphyaena barracuda</i>	great barracuda	tazar lichien	Sphyaenidae	
<i>Harengula ovalis</i>	herring	grosse sardine	Clupeidae	
<i>Diodon hystrix</i>	spot-fin porcupinefish	boule tangué	Diodontidae	
<i>Lactoria cornuta</i>	longhorn cowfish	coffre	Ostraciidae	
<i>Synanceja verrucosa</i>	stonefish	laffe	Synanceiidae	

\*\* This list is subsetted from the original toxic species list to include only fish species

(1) Allowed if caught (a) on an oceanic bank and <3 kg entire (<2.6 kg gutted) or (b) locally caught in Mauritius and <1.5 kg entire (1.3 kg gutted)

(2) Allowed if caught on an oceanic bank and <3 kg entire (<2.6 kg gutted)

(3) Allowed if fished in the Exclusive Economic Zone of the Seychelles

(4) Species of Carangidae are allowed if fished in a locale other than an ocean bank

Source: Fisheries and Marine Resources (Toxic Fish) Regulations (Anonymous 2004)

**Sampling strategy**

**Equipment**

- Vessel properly equipped for safety
- Global Positioning System (GPS)
- Spear gun or fishing pole as necessary for fish collection in shallow (<6 m) and/or deeper (6-20 m) waters
- Snorkelling equipment
- Wire to string fish together (from gills through mouth) (Fig. 3)
- Plastic ziploc bags for samples
- Permanent markers for labelling bags
- Cooler with ice
- Set of filet knives and scissors
- Cutting board
- Thick gloves for handling fish
- Ruler and gridded paper to measure fish
- Scale to weigh fish
- Notebook to record name, size, weight, ID#
- Plastic identification cards
- Paper towels and empty bags for trash
- Camera

**Sampling location**

The sampling site should be determined according to the objective of the study and may include the following: a zone known to be non-toxic for surveillance of a fishing area, an area known to be highly toxic based on local knowledge or epidemiological data to assess greatest risk, and/or an area with recent natural or anthropogenic damage to assess impacts. Sampling in areas known by the local population to be ciguatoxic (hot spots) will target maximal tissue concentrations of toxin. Recently disturbed reefs, whether with physical damage (e.g. hurricane/cyclone) or with coral mortality (e.g. bleaching, crown of thorns seastars, etc) may be important



**Figure 3.** Fish strung together for transport, with wire going through the gills and mouth (photo credit: Institut Louis Malarde, French Polynesia).

sites for pre-emptive risk assessment (Chateau-Degat *et al.* 2005, Rongo and van Woessik 2013). These reefs are often rapidly colonized by macroalgae and may provide substrate for high densities of *Gambierdiscus* spp. that, after a lag time (Bagnis 1969, Kaly and Jones 1994, Chateau-Degat *et al.* 2005, Rongo and van Woessik 2013), can lead to subsequent fish toxicity (Bagnis 1994, but see Rongo and van Woessik 2011). Additionally, areas where densities of herbivorous fish have rapidly increased may be highly susceptible to CFP outbreaks (Bagnis *et al.* 1988, Rongo and van Woessik 2013) and may be targeted for pre-emptive sampling.

Fish should be sampled between 0 to 20 m depth using a spear gun or other fishing equipment, as appropriate for the species and the location. Sampling locations should be recorded by GPS at the time of collection for further mapping.

### Species selection

In general, sampling should target consumed or high-risk fish species of different trophic levels, including individuals from a range of ages. Because of potential variance in toxicity with fish age, several individuals of each species should be collected and screened, encompassing the largest size range possible (small, medium, and large). Practically, where possible, 15 individuals each of herbivorous and carnivorous fish should be collected. In applicable locations (e.g. the Caribbean), 10 lionfish and 3 barracuda specimens should be taken to target higher trophic level fish. Comprehensive risk-assessment may also include sampling of locally-consumed marine invertebrates implicated in CFP in the region [e.g. giant clam in the south Pacific (New Caledonia, Vanuatu, French Polynesia): Laurent *et al.* 2012; octopus in the Republic of Kiribati: Mak *et al.* 2013).

Herbivorous and carnivorous fish species may also be selected according to local reports of which species are ciguatoxic, **as affected species can vary regionally**. Such information may be public record or may require an inventory of ciguatoxic species via surveying local fishermen and consumers. Reports of ciguatoxicity by fish species can also be found on various websites, such as Fish Base (<http://www.fishbase.org/Topic/List.php?group=27>) or Ciguatera Online ([www.ciguatera-online.com](http://www.ciguatera-online.com)).

For surveillance of a fishing area, commonly consumed herbivorous and carnivorous fish species should be selected. In recently disturbed areas, primarily lower-trophic level fish species should be targeted, as they are the first to accumulate CTXs (Lewis and Holmes 1993). In purportedly non-toxic zones, sampling should include both species known to be at high-risk in nearby hot spots as well as indicator herbivorous species [scarids or acanthurids, e.g. *Ctenochaetus* spp. (Lewis *et al.* 1994) or *Naso* spp. in French Polynesia (Gaboriau *et al.* 2014)].

### Sampling frequency

The sampling frequency should be determined by the goal of the study. For continued monitoring of ciguatoxicity, quarterly sampling will provide information about seasonal and general temporal variability without risking declines in fish populations by over-sampling. For infrequent risk-assessment, sampling can be conducted once or twice per year. In areas with recent disturbance or other suspected new outbreak areas, quarterly sampling should commence three months after the disturbance, as long-term (4 years) survey data shows a ~10 month lag time between a major coral bleaching episode and *Gambierdiscus* peak cell density (Fig. 4; Chinain *et al.* 1999). Alternatively, with ongoing monitoring for *Gambierdiscus* (see recommendations in Chapter 3), sampling can begin immediately after the appearance of *Gambierdiscus* cells, as only a ~3 month-lag time is observed between peak cell density and maximum number of reported CFP cases (Fig. 4; Chateau-Degat *et al.* 2005). In the cases of planned disturbance such as construction, dredging, etc., fish should be sampled before the event and a minimum of three months after the event.

### Sample processing

#### Labelling

Complete labelling of specimens is essential and should include the date (typically date of initial observation), site, species code (first two letters of genus and of species, if known) and specimen number, as well as any additional relevant information (see Fig. 5). For example, **2015/10/27-CIEN-FUEGOS-ChMi-002** indicates a specimen of *Chlorurus microrhinos* (ChMi) caught in Cienfuegos on 27 October 2015 that was the second overall fish sampled (002). All sample

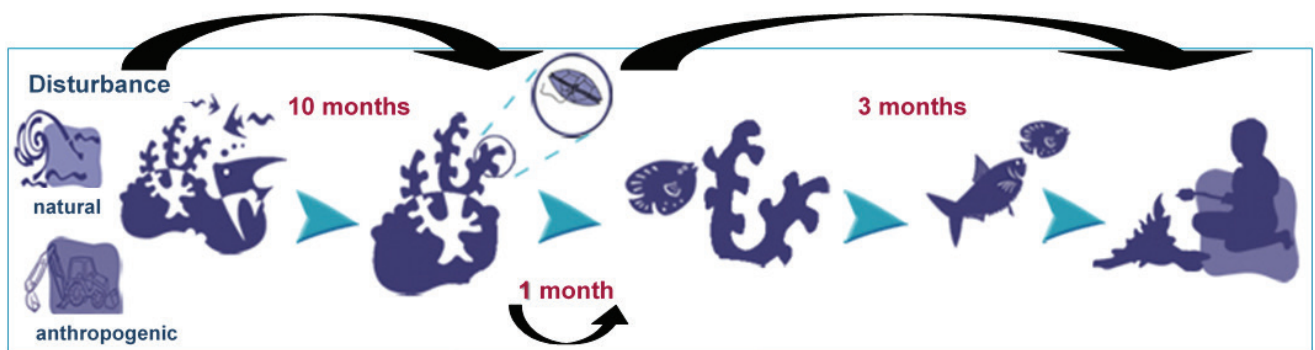

**Figure 4.** Graphic depicting the lag-time from environmental disturbances to occurrence of *Gambierdiscus* cells and transfer of ciguatoxins into the food web and ultimately to humans.



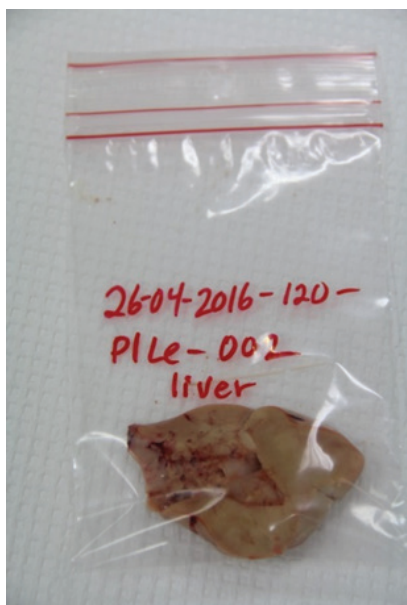

**Figure 5.** Properly labelled fish liver sample in a plastic Ziploc bag

containers must be labelled in indelible ink so that labels remain legible when wet. Additionally, a small tag indicating the label and, if possible, more detailed information should be placed inside the sample container. Sampling sites may also be assigned numeric codes for the purpose of labelling, but this information must be included in the detailed information and on electronic data sheets.

Electronic data sheets should be kept that include the following information: species and common name, date (typically date of initial observation or collection), location (latitude/longitude in decimal degrees; numeric site code, if applicable), fish length, weight, condition, sex if known, and any other relevant information.

### Tissue sample preparation and storage

#### Tissue for toxin analysis

Specimens must be transported to the laboratory on ice (Fig. 6a). Prior to dissection, each fish should be measured (length, cm) (Fig. 6b), weighed (g), and photographed on gridded paper (if possible; Fig. 6c).

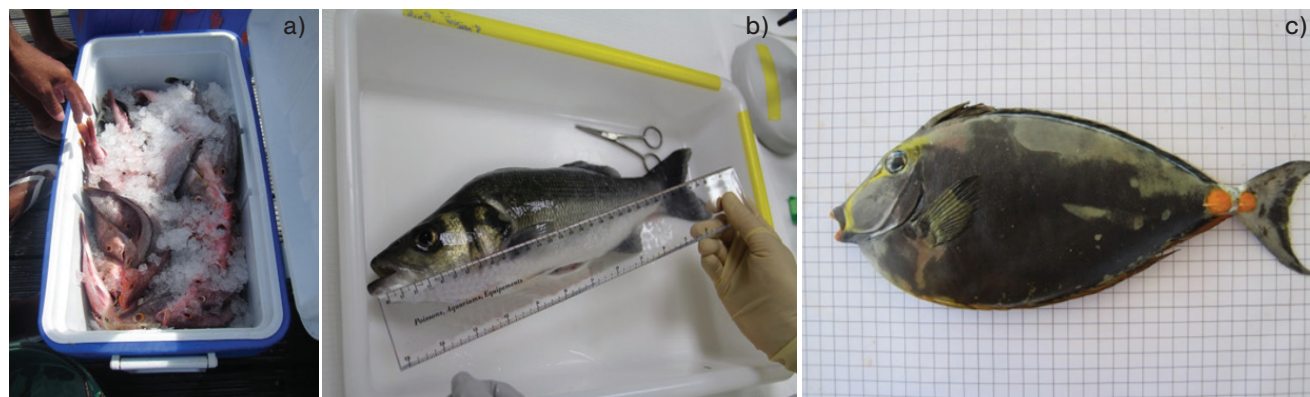

**Figure 6.** (a) Transporting fish from collection site in a cooler with ice and (b,c) taking length measurement of collected fish using a ruler (b) and a photo taken on gridded paper (c).

Muscle tissue should be prepared as fillets (50 g minimum if possible) and the liver should be removed and stored separately (see Fig. 7 for illustration of dissection process). Tissue can then be stored at  $-20^{\circ}\text{C}$  in plastic bags until analysis for toxin content. Alternatively, tissue can be freeze-dried or oven-dried and kept in bags or containers in relatively dry and cool conditions until the day prior to extraction, when they should be reconstituted with triple-distilled water to achieve initial wet weight. Initial wet weight and corresponding dry weight must be logged for calculation of toxin concentration per gram tissue.

#### Tissue for determination of sample identification, age, and trophic level

If possible, specimens should be identified before freezing. Because misidentification of species may occur for some specific groups of fish (see Clua *et al.* 2011 for the species *Plectropomus laevis*), a clip of pectoral fin (Fig. 8) may be taken from each fish and stored in ethanol to confirm species identification using molecular techniques.

Otoliths may also be extracted from specimens for age determination (Fig. 9a). To remove otoliths, make a shallow horizontal cut across the top of the head (Fig. 9b) to reveal the brain. Gently extract the brain tissue with tweezers to reveal the otoliths (Fig. 9c), which are located underneath the caudal part of the brain (Fig. 9d). Otoliths may appear clear and glassy *in situ* (Fig. 9e). Otoliths can also be removed at a later time if the head is kept and stored at  $-20^{\circ}\text{C}$ .

Because evidence suggests that toxicity may vary with trophic level (e.g. a weak positive correlation between fish P-CTX-1B concentration and trophic level; Mak *et al.* 2013), the trophic level of all sampled fish should be recorded. Trophic level can be obtained from the “Ecology” table that is linked in the “more information” section of a species summary page in FishBase (Froese and Pauly 2006). Where trophic level is not available in FishBase, it can be estimated from the trophic levels of the organisms that it consumes (also found in the “Food Items” table in FishBase). Alternatively, relative trophic levels among samples can be estimated by the changes in ratios of stable nitrogen isotopes ( $\delta^{15}\text{N}$  [in ‰] =  $1000 \times [(^{15}\text{N}/^{14}\text{N})_{\text{sample}} / (^{15}\text{N}/^{14}\text{N})_{\text{air}}] - 1$ ) in tissue samples (Zanden and Rasmussen 2001), where the  $\Delta\delta^{15}\text{N}$  (fractionation) between the flesh of the consumer and the diet is generally 3-4‰.

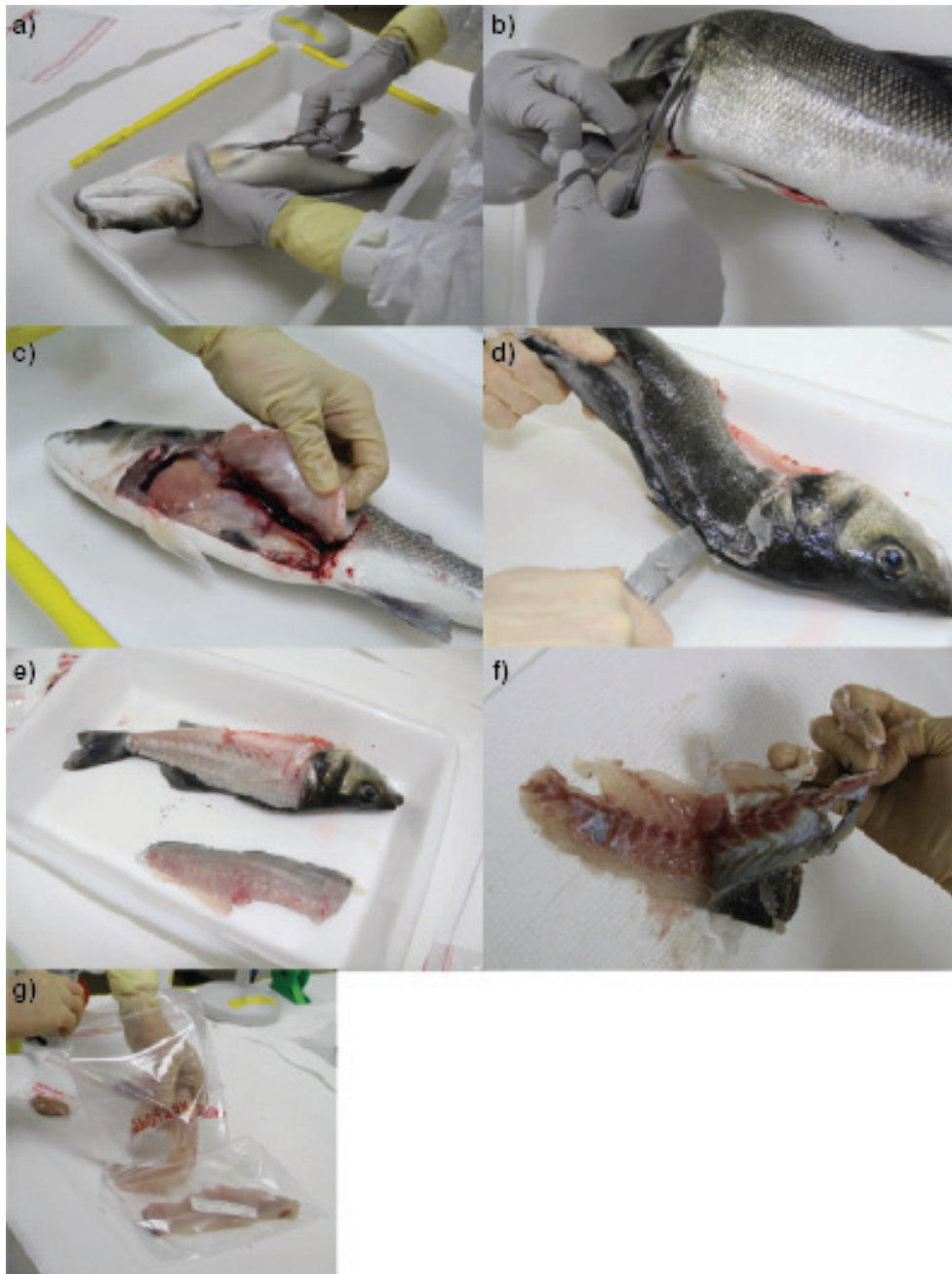

**Figure 7.** Illustration of the dissection process: (a) insert scissors in anus and cut the fish open up to the jaw; (b) cut the skin vertically along the gills; (c) lift the skin to reveal the viscera; (d) run the knife lengthwise from the tail to head along the vertebrae to remove the fillet (e); (f) pull the skin off the fillet after making an initial vertical cut into the flesh to the skin; (g) put the fillet into a ziploc bag fully labelled with permanent ink.



**Figure 8.** A clipped pectoral fin to be used for species identification by molecular analysis (photo credit: Institut Louis Malarde, French Polynesia)



**Figure 9.** Removal of otoliths (a) by making a shallow cut across the top of the head (b), removing the brain matter (c), and removing the glossy, pearly colored otoliths (d,e). (photo credit: Institut Louis Malarde, French Polynesia)

### Sample shipment

If fish are being shipped to a laboratory for analysis, small fish can be shipped whole. For large individuals, the stomach (contents intact), liver and muscle tissue (ideally 50 g tissue) should be removed and stored separately. Whole fish and tissues samples may be stored frozen ( $-20^{\circ}\text{C}$ ) in plastic bags until shipment on dry ice. Tissue samples may also be dried (oven- or freeze-dried), packaged in plastic bags or other convenient containers, and shipped at room temperature. An electronic version of data sheets and sample logs should be sent to the laboratory to identify the samples.

**All shipments must be processed in accordance with recipient country regulations.**

### Acknowledgments

The International Atomic Energy Agency is grateful to the Government of the Principality of Monaco for the support provided to its Environment Laboratories.

### References

- Anonymous (1996) Ministerio de la Industria Pesquera. Resolucion No. 457/96. Gaceta Oficial de la República Cuba, 4 pp.
- Anonymous (2002) Prefecture de la Guadeloupe. Arrêté Préfectoral n°2002/1249 du 19/08/2002: Annexes n°2,3. <http://www.guadeloupe.pref.gouv.fr/Actualites/Message-d-information-sur-la-Ciguatera>
- Anonymous (2004) Fisheries and Marine Resources (Toxic Fish) Regulations. Government Notice No. 193, 2004. Government Gazette of Mauritius No. 114.

- Anonymous (2009) Prefecture de la Reunion. Reglementant la commercialisation de certaines espèces de poisons marins tropicaux, Arrete No: 2009/SG/DRCTCV.
- Bagnis R (1969) Birth and development of an outbreak of ciguatera on a Tuamotu atoll. *Revue des Corps de Sante Armees* 10: 783-795.
- Bagnis R (1994) Natural versus anthropogenic disturbances to coral reefs: comparison in epidemiological patterns of ciguatera. *Memoirs of the Queensland Museum* 34: 455-460.
- Bagnis R, Bennett J, Barsinas M, Drollet JH, Jacquet G, Legrand AM, Cruchet PH, Pascal H (1988) Correlation between ciguateric fish and damage to reefs in the Gambier Islands (French Polynesia). In: Choat JH, Bellwood O (eds) 2, Proc. 6th Int. Coral Reef Symp., Townsville, Australia, pp. 195-200.
- Caillaud A, de la Iglesia P, Darius HT, Pauillac S, Aligizaki K, Fraga S, Chinain M, Diogène J (2010) Update on methodologies available for ciguatera determination: perspectives to confront the onset of ciguatera fish poisoning in Europe. *Mar. Drugs* 8: 1838-1907.
- Chateau-Degat ML, Chinain M, Cerf N, Gingras S, Hubert B, Dewailly É (2005) Seawater temperature, *Gambierdiscus* spp. variability and incidence of ciguatera poisoning in French Polynesia. *Harmful Algae* 4: 1053-1062.
- Chinain M, Darius HT, Ung A, Cruchet P, Wang Z, Ponton D, Laurent D, Pauillac S (2010a) Growth and toxin production in the ciguatera-causing dinoflagellate *Gambierdiscus* polynesiensis (Dinophyceae) in culture. *Toxicon* 56: 739-750.
- Chinain M, Darius HT, Ung A, Fouc MT, Revel T, Cruchet P, Pauillac S, Laurent D (2010b) Ciguatera risk management in French Polynesia: the case study of Raivavae Island (Australes Archipelago). *Toxicon* 56: 674-690.
- Clua E, Brena PF, Lecasle C, Ghnassia R, Chauvet C (2011) Prevalence and proposal for cost-effective management of the ciguatera risk in the Noumea fish market, New Caledonia (South Pacific). *Toxicon* 58: 591-601.
- Cooper M (1964) Ciguatera and other marine poisoning in the Gilbert Islands. *Pac. Sci.* 25: 411-440.
- Cruz-Rivera E, Villareal TA (2006) Macroalgal palatability and the flux of ciguatera toxins through marine food webs. *Harmful Algae* 5: 497-525.
- Darius HT, Ponton D, Revel T, Cruchet P, Ung A, Tchou Fouc M, Chinain M (2007) Ciguatera risk assessment in two toxic sites of French Polynesia using the receptor-binding assay. *Toxicon* 50: 612-626.
- Dechraoui MY, Naar J, Pauillac S, Legrand AM (1999) Ciguatoxins and brevetoxins, neurotoxic polyether compounds active on sodium channels. *Toxicon* 37: 125-143.
- Dechraoui M-YB, Tiedeken JA, Persad R, Wang Z, Granade HR, Dickey RW, Ramsdell JS (2005) Use of two detection methods to discriminate ciguatoxins from brevetoxins: Application to great barracuda from Florida Keys. *Toxicon* 46: 261-270.
- Dickey RW, Plakas SM (2010) Ciguatera: a public health perspective. *Toxicon* 56: 123-136.
- Dierking J, Campora CE (2009) Ciguatera in the Introduced Fish *Cephalopholis argus* (Serranidae) in Hawaii and Implications for Fishery Management 1. *Pac. Sci.* 63: 193-204.
- EFSA (2010) EFSA Panel on Contaminants in the Food Chain. Scientific Opinion on marine biotoxins in shellfish-Emerging toxins: Ciguatoxin group. *EFSA Journal* 8: 1627-1665.
- Gaboriau M, Ponton D, Darius HT, Chinain M (2014) Ciguatera fish toxicity in French Polynesia: Size does not always matter. *Toxicon* 84: 41-50.
- Hamilton B, Hurbungs M, Jones A, Lewis RJ (2002a) Multiple ciguatoxins present in Indian Ocean reef fish. *Toxicon* 40: 1347-1353.
- Hamilton B, Hurbungs M, Vernoux J-P, Jones A, Lewis RJ (2002b) Isolation and characterisation of Indian Ocean ciguatoxin. *Toxicon* 40: 685-693.
- Kaly UL, Jones GP (1994) Long-term effects of blasted boat passages on intertidal organisms in Tuvalu: A meso-scale human disturbance. *B. Mar. Sci.* 54: 164-179.
- Laurent D, Kerbrat AS, Darius HT, Rossi F, Yeeting B, Haddad M, Golubic S, Pauillac S, Chinain M (2012) Ciguatera Shellfish Poisoning (CSP): a new ecotoxicological phenomenon from cyanobacteria to humans via giant clams. In: Jensen MA (ed) *Food Chains: New Research*. Nova Science Publishers, Inc., Toulouse, pp. 1-44.
- Laurent D, Yeeting B, Labrosse P, Gaudechoux J-P (2005) Ciguatera: field reference guide. Un guide pratique. Institut de Recherche pour le Développement-Nouméa, Secretariat of the Pacific Community.
- Ledreux A, Brand H, Chinain M, Bottein M-YD, Ramsdell JS (2014) Dynamics of ciguatoxins from *Gambierdiscus* polynesiensis in the benthic herbivore *Mugil cephalus*: Trophic transfer implications. *Harmful Algae* 39: 165-174.
- Lehane L, Lewis RJ (2000) Ciguatera: recent advances but the risk remains. *Int. J. Food Microbiol.* 61: 91-125.
- Lewis RJ, Holmes MJ (1993) Origin and transfer of toxins involved in ciguatera. *Comp Biochem. Phys. C.* 106: 615-628.
- Lewis RJ, Jones A (1997) Characterization of ciguatoxins and ciguatoxin congeners present in ciguateric fish by gradient reverse-phase high-performance liquid chromatography/mass spectrometry. *Toxicon* 35: 159-168.
- Lewis RJ, Jones A, Vernoux J-P (1999) HPLC/tandem electrospray mass spectrometry for the determination of Sub-ppb levels of Pacific and Caribbean ciguatoxins in crude extracts of fish. *Anal. Chem.* 71: 247-250.
- Lewis RJ, Norton RS, Brereton IM, Eccles CD (1993) Ciguatoxin-2 is a diastereomer of ciguatoxin-3. *Toxicon* 31: 637-643.
- Lewis RJ, Sellin M, Gillespie NC, Holmes MJ, Keys A, Street R, Smythe H, Thaggard H, Bryce S (1994) Ciguatera and herbivores- uptake and accumulation of ciguatoxins in *Ctenochaetus striatus* on the Great Barrier Reef. *Memoirs of the Queensland Museum. Brisbane* 34: 565-570.
- Lewis RJ, Sellin M, Poli MA, Norton RS, MacLeod JK, Sheil MM (1991) Purification and characterization of ciguatoxins from moray eel (*Lycodontis javanicus*, Muraenidae). *Toxicon* 29: 1115-1127.
- Lewis RJ, Sellin M, Street R, Holmes M, Gillespie N (1992) Excretion of ciguatoxin from moray eels (Muraenidae) of the central Pacific. In: Tosteson T (ed) *Proc. 3rd Int. Conf. on Ciguatera Fish Poisoning*. Polysciences, Quebec, pp. 131-143.
- Lewis RJ, Vernoux J-P, Brereton IM (1998) Structure of Caribbean ciguatoxin isolated from *Caranx latus*. *J. Am. Chem. Soc.* 120: 5914-5920.
- Litaker RW, Vandersea MW, Faust, Kibler SR, Nau AW, Holland WC, Chinain M, Holmes MJ, Tester PA (2010) Global distribution of ciguatera causing dinoflagellates in the genus *Gambierdiscus*. *Toxicon* 56: 711-730.
- Mak Y, Wai T, Murphy M, Chan W, Wu J, Lam J, Chan L, Lam P (2013) Pacific ciguatoxins in food web components of coral reef systems in the Republic of Kiribati. *Environ. Sci. Technol.* 47: 14070-14079.

- Murata M, Legrand AM, Ishibashi Y, Fukui M, Yasumoto T (1990) Structures and configurations of ciguatera toxin from the moray eel *Gymnothorax javanicus* and its likely precursor from the dinoflagellate *Gambierdiscus toxicus*. *J. Am. Chem. Soc.* 112: 4380-4386.
- O'Toole AC, Bottein M-YD, Danylchuk AJ, Ramsdell JS, Cooke SJ (2012) Linking ciguatera poisoning to spatial ecology of fish: A novel approach to examining the distribution of biotoxin levels in the great barracuda by combining non-lethal blood sampling and biotelemetry. *Sci. Total Environ.* 427: 98-105.
- Olsen DA, Nellis DW, Wood RS (1984) Ciguatera in the eastern Caribbean. *Mar. Fish. Rev.* 46: 13-18.
- Oshiro N, Yogi K, Asato S, Sasaki T, Tamanaha K, Hiram M, Yasumoto T, Inafuku Y (2010) Ciguatera incidence and fish toxicity in Okinawa, Japan. *Toxicon* 56: 656-661.
- Parsons M, Settlemier C, Ballauer J (2011). An examination of the epiphytic nature of *Gambierdiscus toxicus*, a dinoflagellate involved in ciguatera fish poisoning. *Harmful Algae* 10: 598-605.
- Pottier I, Hamilton B, Jones A, Lewis RJ, Vernoux J-P (2003) Identification of slow and fast-acting toxins in a highly ciguateric barracuda (*Sphyraena barracuda*) by HPLC/MS and radiolabelled ligand binding. *Toxicon* 42: 663-672.
- Pottier I, Vernoux J-P, Jones A, Lewis RJ (2002a) Analysis of toxin profiles in three different fish species causing ciguatera fish poisoning in Guadeloupe, French West Indies. *Food Addit. Contam.* 19: 1034-1042.
- Pottier I, Vernoux J-P, Jones A, Lewis RJ (2002b) Characterisation of multiple Caribbean ciguateric toxins and congeners in individual specimens of horse-eye jack (*Caranx latus*) by high-performance liquid chromatography/mass spectrometry. *Toxicon* 40: 929-939.
- Rains LK, Parsons ML (2015) *Gambierdiscus* species exhibit different epiphytic behaviors toward a variety of macroalgal hosts. *Harmful Algae* 49: 29-39.
- Robertson A, Garcia AC, Flores-Quintana HA, Smith TB, Castillo BF, Reale-Munroe K, Gulli JA, Olsen DA, Hooe-Rollman JJ, Jester ELE, Klimek BJ, Plakas SM (2014) Invasive lionfish (*Pterois volitans*): A potential human health threat for ciguatera fish poisoning in tropical waters. *Mar. Drugs* 12: 88-97.
- Roeder K, Erler K, Kibler S, Tester P, Van The H, Nguyen-Ngoc L, Gerdt G, Luckas B (2010) Characteristic profiles of Ciguatera toxins in different strains of *Gambierdiscus* spp. *Toxicon* 56: 731-738.
- Rongo T, van Woesik R (2011) Ciguatera poisoning in Rarotonga, southern Cook islands. *Harmful Algae* 10: 345-355.
- Rongo T, van Woesik R (2013) The effects of natural disturbances, reef state, and herbivorous fish densities on ciguatera poisoning in Rarotonga, southern Cook Islands. *Toxicon* 64: 87-95.
- Satake M, Fukui M, Legrand AM, Cruchet P, Yasumoto T (1998) Isolation and structures of new ciguatera toxin analogs, 2, 3-dihydroxyCTX3C and 51-hydroxyCTX3C, accumulated in tropical reef fish. *Tetrahedron Lett.* 39: 1197-1198.
- Satake M, Ishibashi Y, Legrand AM, Yasumoto T (1996) Isolation and structure of ciguatera toxin-4A, a new ciguatera precursor, from cultures of dinoflagellate *Gambierdiscus toxicus* and parrotfish *Scarus gibbus*. *Biosci. Biotech. Biochem.* 60: 2103-2105.
- Satake M, Murata M, Yasumoto T (1993) The structure of CTX3C, a ciguatera toxin congener isolated from cultured *Gambierdiscus toxicus*. *Tetrahedron Lett.* 34: 1975-1978.
- Soliño L, Widgy S, Pautonnier A, Turquet J, Loeffler CR, Quintana HAF, Diogène J (2015) Prevalence of ciguateric toxins in lionfish (*Pterois* spp.) from Guadeloupe, Saint Martin, and Saint Barthélemy Islands (Caribbean). *Toxicon* 102: 62-68.
- Tosteson T, Ballantine D, Durst H (1988) Seasonal frequency of ciguateric barracuda in southwest Puerto Rico. *Toxicon* 26: 795-801.
- Vernoux J-P, Lewis RJ (1997) Isolation and characterisation of Caribbean ciguateric toxins from the horse-eye jack (*Caranx latus*). *Toxicon* 35: 889-900.
- Wong CK, Hung P, Lo JYC (2014) Ciguatera fish poisoning in Hong Kong—a 10-year perspective on the class of ciguateric toxins. *Toxicon* 86: 96-106.
- Yang Z, Luo Q, Liang Y, Mazumder A (2016) Processes and pathways of ciguatera toxin in aquatic food webs and fish poisoning of seafood consumers. *Environ. Rev.* 24: 144-150.
- Yasumoto T, Igarashi T, Legrand AM, Cruchet P, Chinain M, Fujita T, Naoki H (2000) Structural elucidation of ciguatera toxin congeners by fast-atom bombardment tandem mass spectrometry. *J. Am. Chem. Soc.* 122: 4988-4989.
- Yogi K, Oshiro N, Inafuku Y, Hiram M, Yasumoto T (2011) Detailed LC-MS/MS analysis of ciguateric toxins revealing distinct regional and species characteristics in fish and causative alga from the Pacific. *Anal. Chem.* 83: 8886-8891.
- Zanden M, Rasmussen JB (2001) Variation in  $\delta^{15}\text{N}$  and  $\delta^{13}\text{C}$  trophic fractionation: implications for aquatic food web studies. *Limnol. Oceanogr.* 46: 2061-2066.

*List of previous titles in the series continued:*

<b>No.</b>	<b>Title</b>
	Vol. 5: Reference Manual for the GF3-Proc Software. 1992. 67 pp. (English, French, Spanish, Russian)
	Vol. 6: Quick Reference Sheets for GF3 and GF3-Proc. 1989. 22 pp. (English, French, Spanish, Russian)
18	User Guide for the Exchange of Measured Wave Data. 1987. 81 pp. (English, French, Spanish, Russian)
19	Guide to IGOSS Specialized Oceanographic Centres (SOCs). 1988. 17 pp. (English, French, Spanish, Russian)
20	Guide to Drifting Data Buoys. 1988. 71 pp. (English, French, Spanish, Russian)
21	(Superseded by IOC Manuals and Guides No. 25)
22 rev.	GTSP Real-time Quality Control Manual, First revised edition. 2010. 145 pp. (English)
23	Marine Information Centre Development: An Introductory Manual. 1991. 32 pp. (English, French, Spanish, Russian)
24	Guide to Satellite Remote Sensing of the Marine Environment. 1992. 178 pp. (English)
25	Standard and Reference Materials for Marine Science. Revised Edition. 1993. 577 pp. (English)
26	Manual of Quality Control Procedures for Validation of Oceanographic Data. 1993. 436 pp. (English)
27	Chlorinated Biphenyls in Open Ocean Waters: Sampling, Extraction, Clean-up and Instrumental Determination. 1993. 36 pp. (English)
28	Nutrient Analysis in Tropical Marine Waters. 1993. 24 pp. (English)
29	Protocols for the Joint Global Ocean Flux Study (JGOFS) Core Measurements. 1994. 178 pp. (English)
30	MIM Publication Series: Vol. 1: Report on Diagnostic Procedures and a Definition of Minimum Requirements for Providing Information Services on a National and/or Regional Level. 1994. 6 pp. (English) Vol. 2: Information Networking: The Development of National or Regional Scientific Information Exchange. 1994. 22 pp. (English) Vol. 3: Standard Directory Record Structure for Organizations, Individuals and their Research Interests. 1994. 33 pp. (English)
31	HAB Publication Series: Vol. 1: Amnesic Shellfish Poisoning. 1995. 18 pp. (English)
32	Oceanographic Survey Techniques and Living Resources Assessment Methods. 1996. 34 pp. (English)
33	Manual on Harmful Marine Microalgae. 1995. (English) [superseded by a sale publication in 2003, 92-3-103871-0. UNESCO Publishing]
34	Environmental Design and Analysis in Marine Environmental Sampling. 1996. 86 pp. (English)
35	IUGG/IOC Time Project. Numerical Method of Tsunami Simulation with the Leap-Frog Scheme. 1997. 122 pp. (English)
36	Methodological Guide to Integrated Coastal Zone Management. 1997. 47 pp. (French, English)
37	International Tsunami Survey Team (ITST) Post-Tsunami Survey Field Guide. 2nd Edition. 2014. 120 pp. (English) Post-Tsunami Survey Field Guide. First Edition. 1998. 61 pp. (English, French, Spanish, Russian)

- 38 Guidelines for Vulnerability Mapping of Coastal Zones in the Indian Ocean. 2000. 40 pp. (French, English)
- 39 Manual on Aquatic Cyanobacteria – A photo guide and a synopsis of their toxicology. 2006. 106 pp. (English)
- 40 Guidelines for the Study of Shoreline Change in the Western Indian Ocean Region. 2000. 73 pp. (English)
- 41 Potentially Harmful Marine Microalgae of the Western Indian Ocean  
Microalgues potentiellement nuisibles de l’océan Indien occidental. 2001. 104 pp. (English/French)
- 42 Des outils et des hommes pour une gestion intégrée des zones côtières - Guide méthodologique, vol.II/  
Steps and Tools Towards Integrated Coastal Area Management – Methodological Guide, Vol. II. 2001. 64 pp. (French, English; Spanish)
- 43 Black Sea Data Management Guide (Cancelled)
- 44 Submarine Groundwater Discharge in Coastal Areas – Management implications, measurements and effects. 2004. 35 pp. (English)
- 45 A Reference Guide on the Use of Indicators for Integrated Coastal Management. 2003. 127 pp. (English). ICAM Dossier No. 1
- 46 A Handbook for Measuring the Progress and Outcomes of Integrated Coastal and Ocean Management. 2006. iv + 215 pp. (English). ICAM Dossier No. 2
- 47 TsunamiTeacher – An information and resource toolkit building capacity to respond to tsunamis and mitigate their effects. 2006. DVD (English, Bahasa Indonesia, Bangladesh Bangla, French, Spanish, and Thai)
- 48 Visions for a Sea Change. Report of the first international workshop on marine spatial planning. 2007. 83 pp. (English). ICAM Dossier No. 4
- 49 Tsunami preparedness. Information guide for disaster planners. 2008. (English, French, Spanish)
- 50 Hazard Awareness and Risk Mitigation in Integrated Coastal Area Management. 2009. 141 pp. (English). ICAM Dossier No. 5
- 51 IOC Strategic Plan for Oceanographic Data and Information Management (2008–2011). 2008. 46 pp. (English)
- 52 Tsunami risk assessment and mitigation for the Indian Ocean; knowing your tsunami risk – and what to do about it. 2009. 82 pp. (English)
- 53 Marine Spatial Planning. A Step-by-step Approach. 2009. 96 pp. (English; Spanish). ICAM Dossier No. 6
- 54 Ocean Data Standards Series:  
Vol. 1: Recommendation to Adopt ISO 3166-1 and 3166-3 Country Codes as the Standard for Identifying Countries in Oceanographic Data Exchange. 2010. 13 pp. (English)  
Vol. 2: Recommendation to adopt ISO 8601:2004 as the standard for the representation of date and time in oceanographic data exchange. 2011. 17 pp. (English)
- 55 Microscopic and Molecular Methods for Quantitative Phytoplankton Analysis. 2010. 114 pp. (English)
- 56 The International Thermodynamic Equation of Seawater–2010: Calculation and Use of Thermodynamic Properties. 2010. 190 pp. (English)
- 57 Reducing and managing the risk of tsunamis. Guidance for National Civil Protection Agencies and Disaster Management Offices as Part of the Tsunami Early Warning and Mitigation System in the North-eastern Atlantic, the Mediterranean and Connected Seas Region – NEAMTWS. 2011. 74 pp. (English)
- 58 How to Plan, Conduct, and Evaluate Tsunami Exercises / Directrices para planificar, realizar y evaluar ejercicios sobre tsunamis. 2012. 88 pp. (English, Spanish)

- 59 Guide for designing and implementing a plan to monitor toxin-producing microalgae. Second Edition. 2016. 63 pp. (English, Spanish)
- 60 Global Temperature and Salinity Profile Programme (GTSP) – Data user’s manual, 1st Edition 2012. 2011. 48 pp. (English)
- 61 Coastal Management Approaches for Sea-level related Hazards: Case-studies and Good Practices. 2012. 45 pp. (English)
- 62 Guide sur les options d’adaptation en zone côtières à l’attention des décideurs locaux – Aide à la prise de décision pour faire face aux changements côtiers en Afrique de l’Ouest / A Guide on adaptation options for local decision-makers: guidance for decision making to cope with coastal changes in West Africa / Guia de opções de adaptação a atenção dos decisores locais: guia para tomada de decisões de forma a lidar com as mudanças costeiras na Africa Ocidental. 2012. 52 pp. (French, English, Portuguese). ICAM Dossier No. 7.
- 63 The IHO-IOC General Bathymetric Chart of the Oceans (GEBCO) Cook Book. 2012. 221 pp. (English). Also IHO Publication B-11
- 64 Ocean Data Publication Cookbook. 2013. 41 pp. (English)
- 65 Tsunami Preparedness Civil Protection: Good Practices Guide. 2013. 57 pp. (English)
- 66 IOC Strategic Plan for Oceanographic data and Information Management (2013-2016). 2013. 54 pp. (English/French/Spanish/Russian)
- 67 IODE Quality Management Framework for National Oceanographic Data Centres (in preparation)
- 68 An Inventory of Toxic and Harmful Microalgae of the World Ocean (in preparation)
- 69 A Guide to Tsunamis for Hotels: Tsunami Evacuation Procedures (in preparation)
- 70 A guide to evaluating marine spatial plans. 2014. 96 pp. (English)



Contact:  
IOC Science and Communication Centre on Harmful Algae  
University of Copenhagen  
Marine Biological Section  
Universitetsparken 4  
2100 Copenhagen Ø  
Denmark  
E-mail: [hab.ioc@unesco.org](mailto:hab.ioc@unesco.org)