

Manuals and Guides 14

Intergovernmental Oceanographic Commission

Manual on Sea Level Measurement and Interpretation Radar Gauges

Volume **V**

Manuals and Guides 14

Intergovernmental Oceanographic Commission

Manual on Sea Level

Measurement and Interpretation

Radar Gauges

Volume **V**

The designations employed and the presentation of the material in this publication do not imply the expression of any opinion whatsoever on the part of the Secretariats of UNESCO and IOC concerning the legal status of any country or territory, or its authorities, or concerning the delimitation of the frontiers of any country or territory.

Editing team:

Philip Woodworth (Chair, NOC, UK)

Thorkild Aarup (IOC, UNESCO)

Gaël André, Vincent Donato and Séverine Enet (SHOM, France)

Richard Edwing and Robert Heitsenrether (NOAA, USA)

Ruth Farre (SANHO, South Africa)

Juan Fierro and Jorge Gaete (SHOA, Chile)

Peter Foden and Jeff Pugh (NOC, UK)

Begoña Pérez (Puertos del Estado, Spain)

Lesley Rickards (BODC, UK)

Tilo Schöne (GFZ, Germany)

Contributors to the Supplement - Practical Experiences:

Daryl Metters and John Ryan (Coastal Impacts Unit, Queensland, Australia)

Christa von Hillebrandt-Andrade (NOAA, USA), Rolf Vieten, Carolina Hincapié-Cárdenas and

Sébastien Deroussi (IPGP, France)

Juan Fierro and Jorge Gaete (SHOA, Chile)

Gaël André, Noé Poffa, Guillaume Voineson, Vincent Donato, and Séverine Enet (SHOM, France) and Laurent Testut (LEGOS, France)

Stephan Mai and Ulrich Barjenbruch (BAFG, Germany)

Elke Kühmstedt and Gunter Liebsch (BKG, Germany)

Prakash Mehra, R.G. Prabhudesai, Antony Joseph, Vijay Kumar, Yogesh Agarvadekar, Ryan Luis, M. Soumya,

Bharat Harmalkar and Devika Ghatge (NIO, India)

Hironori Hayashibara (JMA, Japan)

Ruth Farre (SANHO, South Africa)

Begoña Pérez (Puertos del Estado, Spain), Diana López and José María Cortés (SIDMAR, Spain) and

Bernat Puyol (IGN, Spain)

Jeff Pugh, Peter Foden, Dave Jones, Philip Woodworth and Angela Hibbert (NOC, UK)

Travis Mason (Channel Coastal Observatory, UK) and Robin Newman (Fugro EMU Ltd., UK)

Richard Edwing and Robert Heitsenrether (NOAA, USA)

Janice M. Fulford (USGS, USA)

Other information was provided by Les Bradley (NOC, UK), Pat Caldwell and Mark Merrifield (UHSLC, Hawaii, USA), Médéric Gravelle and Guy Wöppelmann (University of La Rochelle, France), Lonny Hansen, Vibeke Huess and Klavs Allerslev (Danish Meteorological Institute) and Belén Míguez Martín (EMODnet, Ostend, Belgium).

In addition, the editing team is grateful to Christoph Blasi (BAFG, Germany), John Boon (USA), John Broadbent (Maritime Safety, Queensland, Australia), Peter Devine (Technical Director, VEGA Controls Ltd., UK), Terry Edwards (Technical Director, RS Aqua Ltd., UK), and Øistein Grønlie (Senior Technical Advisor, Miro, Norway) and Elena Iasyreva (IOC).

Publication designer: Ahmad Korhani, UNESCO. Original design by Eric Loddé.

For bibliographic purposes this document should be cited as follows:

Manual on Sea-level Measurements and Interpretation, Volume V:

Radar Gauges. Paris, Intergovernmental Oceanographic Commission of UNESCO. 104 pp.

(IOC Manuals and Guides No.14, vol. V; JCOMM Technical Report No. 89; (English)

This report has a Supplement titled *Practical Experiences*.

Printed in 2016

By the United Nations Educational, Scientific and Cultural Organization

7, place de Fontenoy, 75352 Paris 07 SP

© UNESCO 2016

Printed in France

(IOC/2016/MG/14Vol.5)

Foreword

The IOC Manual on Sea Level Measurement and Interpretation was first published in 1985 and, after the second volume appeared a decade later, the first edition was reprinted as 'Volume 1: Basic Procedures'.¹ In the mid-1980s, most tide gauges were traditional stilling well and float devices with the tidal curve represented as a pen trace on a chart recorder. The first part of Volume 1 provided some sea level science as background, and then moved on to practical aspects of selecting a suitable tide gauge site. It then discussed in detail how to install and maintain float gauges. The following sections described how to digitise the paper charts, and identify errors of various kinds, resulting in a time series of sea level that could be filtered to provide the tidal and mean sea level information required by scientists and other interested users. A later section discussed mechanisms for data exchange. There was brief mention of other types of tide gauge (i.e. bubbler pressure gauges) and methods for electronic storage of sea level data, instead of using paper charts, for 'remote monitoring'.

A decade later, in 1994, the second volume of the manual appeared entitled 'Emerging Technologies'. This volume reviewed float and pressure tide gauges once again, but also introduced the new method of measuring sea level by means of reflection of an acoustic pulse from a transducer installed above the water. One type of acoustic gauge, based on the Aquatrak transducer, became something of a standard for the Global Sea Level Observing System (GLOSS) programme of the Intergovernmental Oceanographic Commission (IOC) after its adoption for use at many sites in the USA, Australia and other countries. The volume also discussed how data could be recorded electronically and transmitted over telephone lines or satellites to a centre, and described various data processing methods and the role of different sea level centres.

Volume 3 was published in 2002 with the subtitle 'Reappraisals and Recommendations as of the Year 2000'. It reviewed float, pressure and acoustic devices and for the first time mentioned the use of 'radar tide gauges and other new technologies' in half a page. Data transmission

and exchange methods were again reviewed. Volumes 2 and 3 covered similar ground, although they had different authors, and they can usefully be read in combination.

Volume 4 appeared in 2006 entitled 'An Update to 2006'. It again reviewed some of the sea level science and the older tide gauge technologies, and devoted two pages to radar gauges. It had a section on the merits of each technology for use at particular locations. The Sumatra tsunami had occurred in December 2004. The sea level community was now aware that tide gauge sites had to be equipped to measure not only the conventional sea levels used for tidal and mean sea level studies, but also to provide real-time data for storm surge and tsunami warning. This 'multi-hazard' aspect implied that sites should have more than one type of sensor (perhaps radar plus pressure). The primary sensor (radar) would record typically 3-minute average values, or at higher frequency, while a differential pressure transducer (one that measures the difference between water pressure and atmospheric pressure) would record 1-minute values or at higher frequency. The pressure gauge would be the primary tsunami sensor and provide data to fill any short gaps in the radar record. All data would be transmitted rapidly. The stations themselves would be designed to be as resilient as possible to damage during the extreme events. The volume contained sections on real-time data telemetry, data quality control and new technologies, and was more specific than earlier volumes in stating GLOSS requirements. It also contained an Appendix wherein the experiences of individual tide gauge operators were presented, several of which included useful information on operating radar gauges.

A decade later we come to the present Volume 5 which is devoted specifically to 'Radar Tide Gauges'. Radar range finders have been used in industry (where they measure the levels of liquids in tanks) and hydrology (for measuring river, lake and reservoir levels) for many years and, in the decade since Volume 4, have been applied to measuring sea level at many locations. They have already replaced the previous tide gauge technologies in many countries. Their low cost (in most cases) and the fact that they are relatively easy to install and maintain mean that they have been the technology of choice whenever new sites have been instrumented or older ones refurbished. They

¹ Copies of the Volumes may be obtained from http://www.psmsl.org/train_and_info/training/manuals/.

can be interfaced easily to data loggers and telemetry platforms, such that their data can be displayed almost instantly at centres around in the world. However, many questions remain as to their suitability for sea level monitoring within national and international networks such as GLOSS. At the 13th meeting of the GLOSS Group of Experts in Liverpool in November 2013, a new edition of the Manual was proposed that would focus on this particular technology and problems with its use.

Therefore, Part 1 of this Volume 5 discusses topics such as how radar gauges can be mounted over the water to measure sea level. It considers how gauges can be calibrated, either in the laboratory before installation or in the field during routine maintenance visits. It describes how radar performs in comparison to other technologies and discusses how the measured radar levels can be biased in the presence of waves and, consequently, what other technologies must be used in parallel.

Part 2 of this Volume returns to some topics that have been presented in the previous Volumes 1-4 of the Manual. These are particularly important aspects of tide gauge measurements, and so have been repeated each time, although in different ways. Volume 1 introduced the essential procedures to be followed for maintenance of the datum of the sea level measurements (i.e. the stability of the measurements with respect to benchmarks on the nearby land). Volume 2 described how levelling should be undertaken between a local network of benchmarks and introduced the use of Global Positioning System (GPS) receivers for monitoring vertical land movements. GPS at tide gauges was further discussed in Volumes 3 and 4. These sections were based partly on the insight that had been obtained into the use of GPS in the workshops that led to the two 'Carter Reports' (1989 and 1994) and in an important subsequent workshop at the Jet Propulsion Laboratory (1998).² By this time, GPS at tide gauges was being undertaken using continuous (rather than episodic or campaign) and dual- (rather than single-) frequency receivers, and further research into their use had begun within the Tide GAUGE (TIGA) project of the International GNSS Service. The present Volume 5 contains a similar section on the survey methods and benchmark

requirements at tide gauges, including the use of GNSS (Global Navigation Satellite System) equipment, and brings up-to-date the recommendations on the use of GNSS at tide gauge sites.³

Part 2 of the Volume also has updated sections on how tide gauge operators can ensure that their data find their way to centres where they can be used to the maximum extent possible for practical and scientific purposes. For example, it is now inconceivable that gauges installed in the GLOSS network would be without a real-time reporting capability for storm surge and tsunami warning. On the other hand, the data must be of sufficient quality that 'delayed-mode' centres can process them into mean sea level values for use in studies of long-term sea level change. These real-time and delayed mode objectives need not be in competition if care is taken to understand the data that are recorded, essential metadata are compiled, and data are transmitted rapidly to the relevant national and international centres.

We suggest that new readers of the volumes would benefit from looking at Volumes 1-4 before reading the present Volume 5. Although the earlier volumes date from many years ago, and technology has evolved considerably in the meantime, much of the previous discussion is educational with regard to how the historical sea level data set has been obtained. There are often dangers in exchanging one measuring system for another, in that different systematic methods can be introduced into a long-term time series, so an appreciation of how methods have changed is essential. It is clear that the same kind of mistakes in changing technologies could be occurring now, as radar systems replace others, so we must make attempts to understand them all as well as we can.

Therefore, in summary:

Part 1 (Chapters 1-5) reviews the use of tide gauge radar technology.

Part 2 (Chapters 6-9) updates some topics addressed in previous Volumes of this Manual.

² Copies of these reports may be obtained from http://www.psmsl.org/train_and_info/training/reading/.

³ GNSS includes GPS, the American military system that has been operational since the 1980s, and also the Russian (GLONASS), European (Galileo), Japanese (QZSS) and Chinese (BeiDou) systems. One can expect the other GNSS systems to become as important as GPS for monitoring land levels in the future. For the status of each system see <http://igs.org/mgex/status-GPS>.

And specifically:

Chapters 1 and 2 contain the background on the need for tide gauges and on the technology of radar gauges.

Chapter 3 has reviews of experiences of GLOSS groups in using radar for measuring sea level including intercomparisons with other technologies. The individual contributions to this chapter may be obtained from the Supplement.

Chapter 4 moves on to a best-practice guide to installing and operating a radar gauge, the previous chapters having established the acceptability (with caveats) of radar for sea level measurement.

Chapter 5 gives the main bullet points on requirements for GLOSS sites with radar tide gauges.

Chapters 6-8 provide updates to important aspects of datum control and vertical land movement measurement, data acquisition and telemetry, data flow and data banking. (The quality control of sea level data will be discussed in a separate IOC Manual.)

Chapter 9 gives a guide to available sea level training materials.

Table of Contents

Foreword	3
Part 1: Radar Tide Gauges	9
1. Introduction	10
1.1 The Need for Tide Gauges	10
1.2 Earlier Tide Gauges	10
2. Radar Gauges	12
2.1 Types of Radar Gauge	12
2.2 Potential Sources of Radar Measurement Error	14
2.3 Radar Gauges in GLOSS	16
2.4 Wave Measurements at GLOSS Sites	18
2.5 Summary on Radar Gauges for GLOSS	18
3. Experiences with Radar Gauges including Intercomparisons with Other Technologies	19
4. Radar Gauge Installation	24
4.1 The Choice of a Tide Gauge Site	24
4.2 Suitable Radar Gauge Locations	25
4.3 Radar Gauge Mounting	28
4.4 Before Installation	34
4.5 During Installation	37
4.6 After Installation	38
4.7 Need for Other Sensors	40
5. Summary of Requirements for GLOSS Sites with Radar Tide Gauges	42
Part 2: Updated Sections from Previous Manuals	45
6. Datum Control and Levelling	45
6.1 Introduction	47
6.2 Local Benchmarks and Levelling	48
6.3 CGNSS Monitoring of Benchmark Heights	51
6.4 EGNSS Surveys of Benchmark Heights	53
6.5 Other Methods for Measuring VLMs	54
6.6 Other Sea Level Applications of GNSS	56

7. Equipment needed for Telemetry of Data from Radar and Other Tide Gauges	57
7.1 Introduction	57
7.2 Choice of a Telemetry System	58
7.3 Data Transmission Systems.....	59
7.4 Broadcasting Telemetry (the GTS)	69
7.5 DCP and Other Telemetry Equipment	69
7.6 GNSS Data Transmission Requirements.....	73
8. Sea Level Data	74
8.1 Sea Level Data Centres.....	74
8.2 Quality Control of Data.....	77
8.3 Obligations of Data Providers	81
9. Training Materials and Contacts.....	82
References	85
Appendix 1:	
Radar Gauges from Major Manufacturers as of April 2016.....	91
Appendix 2:	
List of Acronyms.....	94
Appendix 3:	
GTS Bulletin Contents and an Example of a DCP Message using CREX Code	98
Supplement:	
Papers on Contributed Practical Experiences of Radar Gauge Operators	

Part **1**

Radar Tide Gauges

1. Introduction

1.1 The Need for Tide Gauges

Rarely a year goes by without some catastrophic sea-level related event appearing in the news. Recent storm surges have included those of Hurricanes Katrina (2005) and Sandy (2012), Cyclone Nargis (2008) and Typhoon Haiyan (2013) in which coastal areas were devastated and many people died. At least 130,000 people are thought to have been killed by Nargis alone. Recent tsunamis have been those of Sumatra (2004) and Tōhoku (or Sendai) (2011), with over 230,000 people killed in the former. These two tsunamis had most impact close to their source, but their waves travelled to many parts of the world coastline where they caused more coastal flooding and damage.

These are just a few examples of major extreme events; Pugh and Woodworth (2014) discuss these and other storm surges and tsunamis in detail. Some events go largely unnoticed, such as the inundation of the remote Haida Gwaii Island coast in 2012 caused by the runup of the largest tsunami on the west coast of Canada in the last 200 years. Most smaller storm surges, and even smaller tsunamis, are otherwise regarded as routine events in many parts of world, where coastal populations have learned to live with occasional high sea levels and where adequate warning systems now exist.

Meanwhile, mean sea level is believed to be rising at an ever-increasing rate and the Intergovernmental Panel on Climate Change tells us that the world coastline should prepare for an additional rise of about half or one metre by 2100 (Church et al., 2013). This rise may result in impacts by itself (e.g. through increased salinization of coastal groundwater) and can only exacerbate the impacts of extreme events.

Therefore, it is as obvious as it possibly can be that the world must have a global coastal sea level monitoring network, such as the GLOSS programme of IOC (IOC, 2012). Only through such a network (of sea level specialists as well as infrastructure) can best practice in sea level monitoring be transmitted around the world for adoption by national agencies within their own networks. As a result, it is intended that national contributions to the international programme will provide a near-worldwide source of the sea level data needed for scientific research.

The need for sea level data within international 'multi-hazard' warning systems and the requirements for scientific research are not the only drivers for sea level measurements. There are many good local practical reasons for such data. For example, some major ports and coastal cities are without any, or adequate, sea level monitoring, even though the capital cost of tide gauges and associated equipment is minute compared to their total expenditure each year. The tide (and sea level in general) has always been an important factor in port operations, especially as the draught of ships has increased. Any city or country with a waterfront needs information on the statistics of tidal and non-tidal sea level variability in order to design adequate defences. When a new sea level installation is proposed at such locations, it would be excellent if port or city authorities could collaborate with scientists so as to equip the site with the best possible hardware that can provide data suitable for all purposes.

1.2 Earlier Tide Gauges

The nearest thing to an ideal tide gauge is a tide board (or tide pole) with which, in calm conditions, sea level can be measured using one's own eyes. The zero of the tide board would be levelled to a benchmark on the nearby land, so one would then, over an extended period, have a good time series of 'relative' sea level (i.e. relative to the nearby land level). A historical variant of this method uses a mini-stilling well in which a float has a vertical rod attached. The height of the top end of the rod would be measured by eye using a tide board; this method was suggested in an article in the first edition of *Philosophical Transactions of the Royal Society* (Moray, 1665).⁴

Unfortunately, such ideal arrangements are not practical ones nowadays for a programme like GLOSS. Agencies are unlikely to have staff willing to sit by a tide board and make optical measurements every few minutes, day and night, summer and winter, year in and year out. More automated methods are needed. However, it can be seen that even the Moray method already introduced issues to

⁴ A similar suggestion for a float gauge was made at about the same time by the German polymath and eccentric Athanasius Kircher.

do with the gauge installation (e.g. How best to mount the stilling well to a harbour wall? How far off the sea bed should its conical inlet be?), and questions concerning possible biases in the measurements (e.g. Is the water level in the well the same as that outside?).

The first automatic or 'self-registering' tide gauges were introduced in the 1830s (Matthäus, 1972) and since then many types of gauge have been invented. However, they have all presented difficulties for installation and maintenance. For example, the big stilling wells that were a common sight at many locations could be installed only with cranes and teams of people, implying organisation and expense. The installation of pressure gauges required the availability of divers.

In addition, different types of gauges presented different kinds of systematic errors. Stilling wells, especially those located in estuaries, provide a particular example. A difference between water density inside the well and that outside, with the difference varying both tidally and seasonally (as the density of the estuary varied through the year), would result in a sea level difference inside and out. In addition, strong tidal currents flowing past the conical inlet would cause Bernoulli draw-down of the level inside the well. Acoustic gauges are well-known to have potential systematic errors due to uncompensated vertical temperature gradients (and therefore a different speed of sound) down the sounding tube for the Aquatrak type or, even worse, within the open air for types without sounding tubes. In addition, although a large amount of research went into the design of the submerged end of the acoustic sounding tube, so as to reduce draw-down, the problem was never eliminated completely. Pressure gauges have biases due to (tidally and seasonally varying) changes in the water density required to convert pressure to sea level. Almost all types of gauge suffer during high wave conditions, primarily due to the large transient currents that the waves induce (for draw-down). In most gauge types that we are aware of, large waves result in measured sea levels being lower than the real ones.

The pros and cons of using float or pressure gauges, or ranging using acoustic time-of-flight (TOF), were discussed in earlier Volumes of this Manual. An omission

concerned optical TOF, which may have application in certain circumstances where a stilling well is a practical option, although with similar concerns about wells as for float gauges.⁵ The present Volume discusses ranging using microwaves which, it will be seen, provides a valuable additional sea level measurement technique.

5 The only publication on laser tide gauges that we know is that of Forbes et al. (2009), who use lasers in heated wells in the Canadian Arctic, although we understand laser gauges have also been used in narrow wells in South Korea. The laser used in Canada has a wavelength of 620-690 nm (red) and reflections are from foam boards that float approximately 8 mm above the water surface. Elsewhere, Washburn et al. (2011) used a LIDAR (Light Detection And Ranging) with a wavelength of 905 nm (near IR) for several years at the Harvest Platform off the California coast with the main aim of validating sea level data from a NOAA bubbler gauge. Reflections took place off the open water, not in a stilling well. High rate LIDAR measurements over open water are more commonly used to record ocean waves (e.g. Irish et al., 2006).

2. Radar Gauges

2.1 Types of Radar Gauge

As is well known, radar (RADio Detection And Ranging) was developed before and during World War II and found application in the detection of aircraft, ships and surfaced submarines. However, in the last quarter-century radar has been employed in many civilian fields, most familiarly in motion detection in traffic control. The development of the tide gauges discussed in this Manual was made possible by the application of semiconductor transistor devices as microwave amplifiers, and the industrial requirement for the measurement of liquids in tanks. Later, the technology was applied to hydrological applications such as the measurement of river, lake and reservoir levels (WMO, 2010).

There are few publications that we know of that describe radar gauges in great detail. The most useful are those of Devine (2000) and Brumbi (2003), albeit written from the perspective of 'process applications' (i.e. in industrial tanks) and not tide gauges and published by individual

manufacturers (VEGA and Krohne respectively). Devine (2000), in particular, provides a good overview of the basic concepts of the technology and its history. Other reports provide briefer explanations (e.g. Mai and Zimmermann, 2000 and Wikipedia, 2015a).

In brief, there are two main types of radar gauge: Frequency Modulated – Continuous Wave (FMCW) radars and pulse radars. (See Brumbi (2003) for mention of other techniques used in industry including interferometric and reflectometer methods.)

(i) Frequency Modulated – Continuous Wave (FMCW) radars

In continuous wave (CW) radar, an electromagnetic beam with a continuous unmodulated frequency is transmitted towards a target, with echoes reflected by the target and received back at the transmitter. If the target is not moving, the frequency of the return echoes will be the same as that transmitted. However, for a moving target the frequency of the return signal depends on its

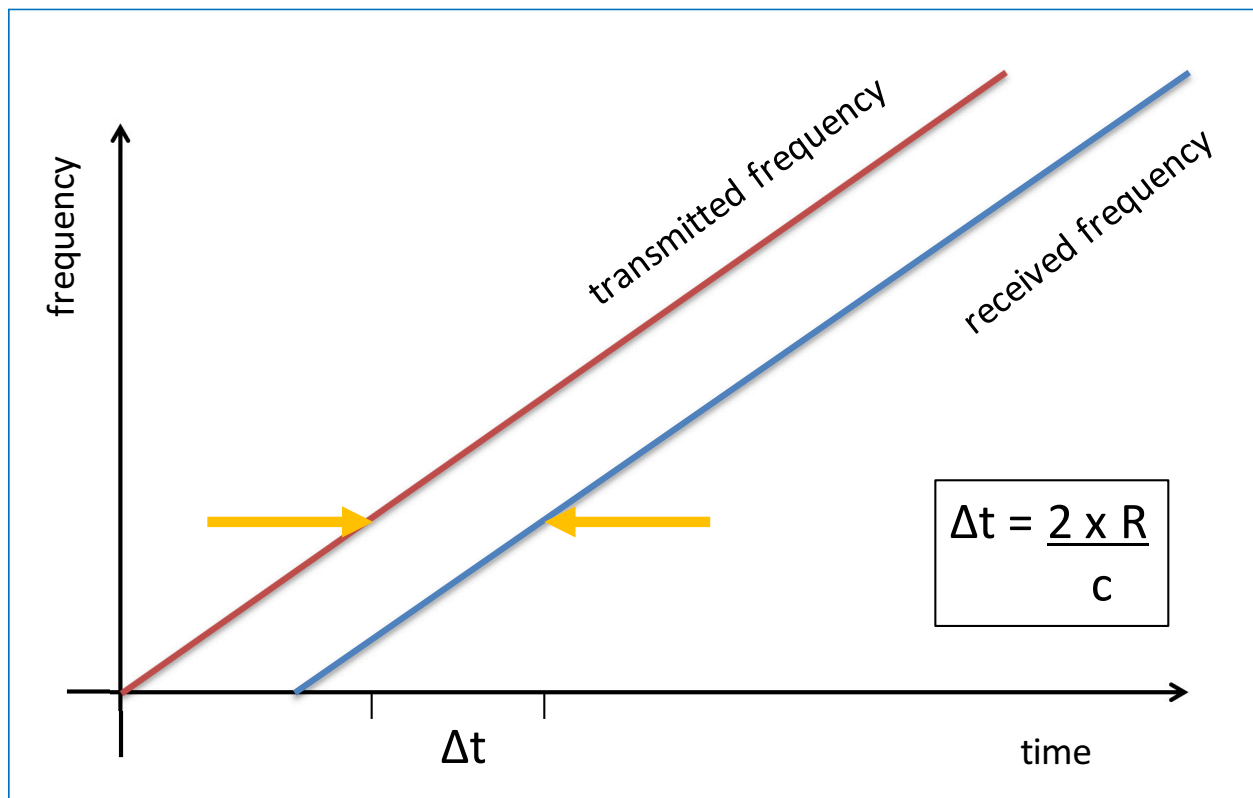

Figure 2.1 The principle of FMCW measurement with the time difference Δt between the same transmitted and received frequencies increasing in proportion to the distance to the target R , where c is the speed of light in air.

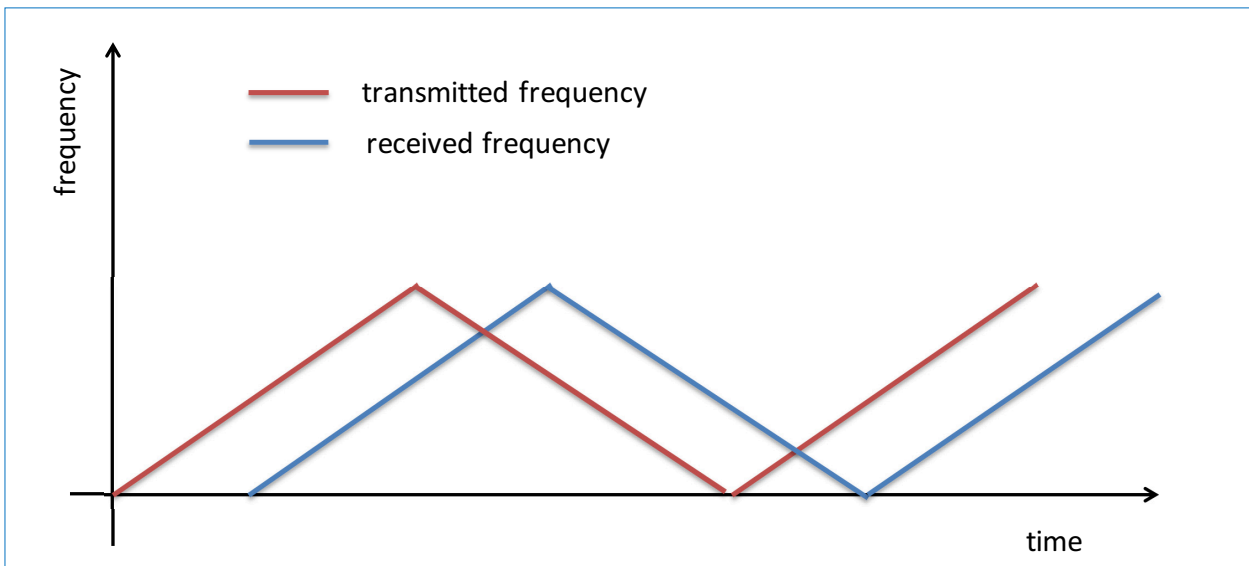

Figure 2.2 Triangular modulation of frequency used in an FMCW radar gauge.

speed toward or away from the transmitter. This is the well-known Doppler Effect. In this case, while the speed of the target can be estimated readily from the shift in frequency, the range from the transmitter to the target cannot be determined.

Devine (2000) describes how a single frequency CW radar cannot measure distance because there is no time reference from which to determine the delay in the return echo from the target. However, a time reference can be obtained by modulating the frequency in a known manner. (Mai and Zimmermann, 2000 call this 'optical phase ranging!') A simple example is shown in **Figure 2.1** where the frequency of the transmitted signal is ramped up in a linear fashion. If R is the distance to the target, and c the speed of light in air, then the time taken for the radar return is $\frac{2R}{c}$. From **Figure 2.1** one can see that if we know the linear rate of change of the transmitted signal and can measure the time difference (Δt) between the transmitted and received frequencies, then R can be readily obtained from Δt . In practice, the received signal reflected from the target is mixed with the signal that is being transmitted at that moment, and the result is a beat frequency proportional to R .

The FMCW transmission has to be cyclic between two different frequencies (e.g. 24 and 26 GHz) but the cyclic modulation can take different forms e.g. sinusoidal, saw tooth or triangular (**Figure 2.2**). Saw tooth modulation is used for most 'process applications' (Devine, 2000). Triangular modulation, as used in the FMCW sensors in Appendix 1, has a linearly increasing frequency sweep, followed by a decreasing sweep, allowing Doppler shifts due to a moving target to be averaged out.

(ii) Pulse radars

In pulse radar one measures the time of flight of short pulses (typically measured in nanoseconds to microseconds) between the transmitter and target and back. Correction for the speed of light and division by 2 gives the range. The pulses take the form of short packets of waves. The number of waves and length of the pulse depend on pulse duration and the carrier frequency that is used. A relatively long delay between pulses is imposed to allow the return echo to be received before the next pulse is transmitted. For our purposes, the target can be considered stationary. In a variant of the method, the Doppler shifted frequency of the return pulse is also measured, enabling both the range and speed of the target to be estimated. This is called 'pulse Doppler radar' and is the technique used for aircraft tracking and in weather radar.

Shorter pulse duration will result in better target resolution and higher accuracy. However, a shorter pulse needs higher peak power if there is to be adequate range performance. If there is a limit to the maximum power available, a short pulse will result in a reduced maximum measurable range. With limited peak power, longer pulse duration provides more radiated energy and, therefore, greater measurable range but, in a standard pulse radar, at the expense of resolution and accuracy. A 'chirp' radar (named after the sharp chirping of birds) is a hybrid of the FMCW and pulse radar techniques, and uses a pulse compression method for achieving the accuracy benefits of a short pulse radar together with the power benefits of using a longer pulse.

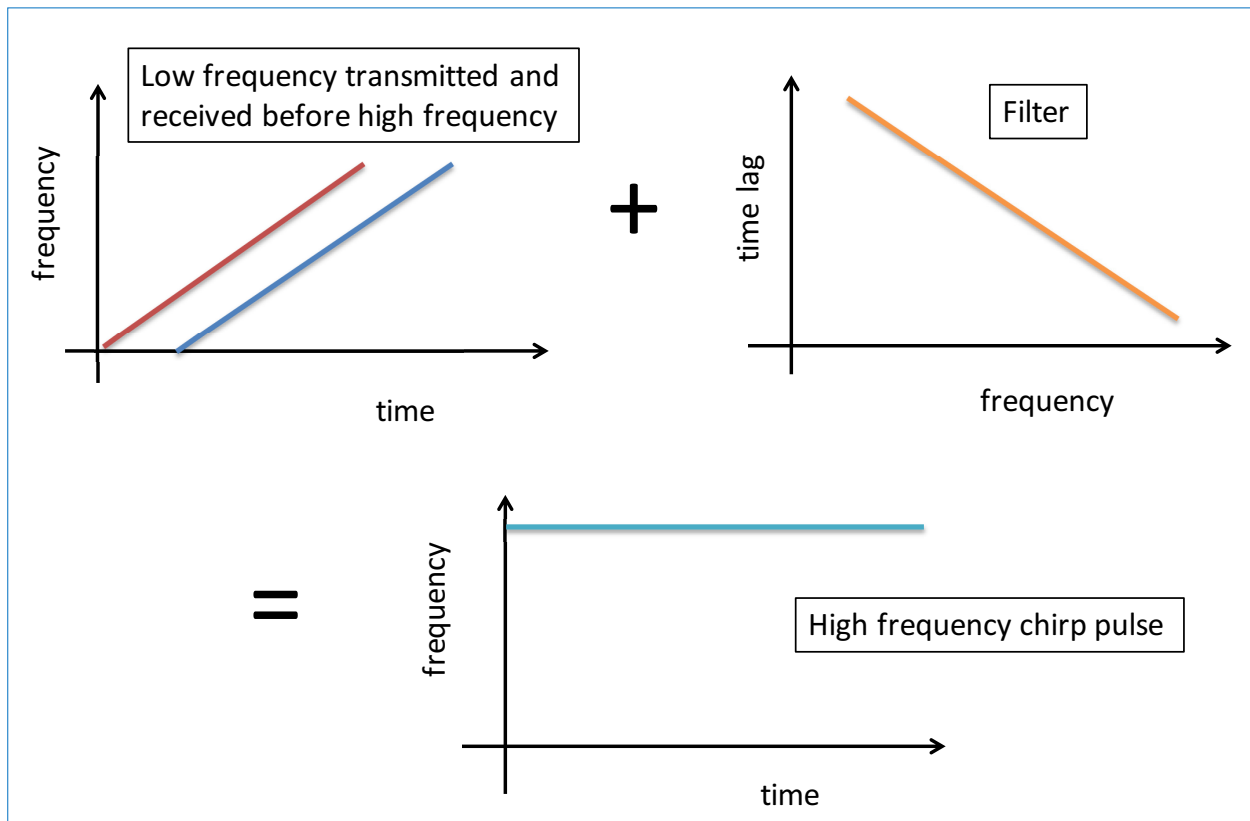

Figure 2.3 A schematic description of chirp pulse compression. Lower frequency waves are transmitted to, and received back from, the target before the higher frequency waves. A filter is applied to the received signals such that the earlier, lower frequency waves are delayed relative to the later, higher frequency waves. The result is compression of energy into a high frequency 'chirp pulse' packet.

In a chirp radar, the emitted pulse frequency is modulated linearly in time (as for the FMCW method in [Figure 2.1](#)) but with a constant amplitude. The returned pulse passes through a filter that compresses the echo by creating a time lag that is inversely proportional to the frequency. Therefore, the low frequency energy that arrives first is slowed down and the subsequent higher frequencies catch up producing a sharper echo signal and improved effective temporal resolution ([Figure 2.3](#)). Devine (2000) provides details of variants of the FMCW, Pulse and Chirp methods.

2.2 Potential Sources of Radar Measurement Error

Before we discuss the inter-comparisons between sea levels measured by radar and other techniques in the next chapter, it is useful to reflect at this point on the known factors that might have an impact on radar accuracy. The list is a short one, and in fact is shorter than the lists that could be made for older tide gauge technologies.

Temperature Changes

An advantage that radar has over acoustic range measurements is that the speed of sound depends on temperature and so, for the highest accuracy, acoustic gauges need to compensate for temperature changes in the air between the transducer and the sea surface. This is particularly problematical when there are large temperature gradients down the acoustic sounding tube. A similar issue does not exist for radar wherein the speed of light in air can be considered for our purposes to be the same for all air temperatures and pressures. (The dependence of the speed of electromagnetic waves under the more extreme temperatures and pressures of 'process applications' is given by Devine, 2000).

A separate question is that the sensors themselves could be sensitive to temperature changes. The information sheets of many manufacturers just state simply that they are not sensitive to temperature. Others quote very small sensitivities. For example, the Waterlog H-3611 is claimed to have a sensitivity of 0.2 mm/K, and maximum 5 mm in the temperature range -40 °C to +80 °C. The VEGAPULS-61 and -62 and VEGAFLEX-81 are claimed similarly to have 0.3 mm/K. Heitsenrether (2010) tested

these claims by placing sensors from four manufacturers in an environmental chamber in which the sensors ranged to a target approximately 1.7 m distant. Temperature varied in 10°C increments from -20° to 50°C with each temperature maintained for one hour. Results showed no changes with temperature for the Waterlog H-3611 and VEGAPULS-62 sensors; results for the other two sensors were inconclusive.

Temperature, humidity and ageing-related changes could be factors in the accompanying electronics, rather than in the gauge itself. For example, André et al. (Supplement) point to the importance of using digital data acquisition rather than a potentially environmentally-sensitive analogue current loop.

Electromagnetic Interference

There exists a voluminous literature on the electromagnetic interference of radar measurements (e.g. jamming of military radars) but none specifically related to radar tide gauges. FMCW devices might be expected to be more prone to interference than pulse systems (Table 2.1) but the electromagnetic environment of any particular location would need to be modelled in detail to study such effects.

Objects in the Beam

Boats, tree trunks or floating rubbish could occasionally pass under the beam and result in false sea level measurements. It is hard to avoid this possibility occurring

Table 2.1

Pros and Cons of Pulse and FMCW Systems

Pulse Systems

Pros

- Pulse systems are a proven technology with long history.
- Long range measurements are possible with high power devices.
- They can be set up to deal with unwanted nearby reflectors easily.
- They have high power requirements during the pulse itself but, due to transmissions occurring over a small percentage of the time, they have lower overall power requirements than FMCW devices.

Cons

- There can be difficulties at short ranges due to short signal travel time.

FMCW Systems

Pros

- Because FMCW devices transmit continuously (typically in practice approximately 50% of the time compared to 1% for pulse systems), there is little delay in updating measurements.
- Their greater bandwidth makes them potentially more accurate than pulse radars and more suitable as wave recorders (although there is no reason in

principle why pulse radars should not also be able to sample fast enough for waves)

- Peak emitted radiation is lower than for pulse systems (with safety implications).
- Lower peak power requirements also imply lower peak power consumption in the supporting electronics.

Cons

- On the other hand, FMCW systems need high-quality FFT processing to achieve high accuracy, which implies more complex hardware and software and higher overall power requirements.
- The higher overall power requirements for FMCW devices than pulse systems means that they may be less suitable for operations at remote sites.
- Due to their generally lower peak power output, they can have reduced range compared to pulse systems (although this is not likely to be a major factor for radar tide gauges).
- Because they transmit continuously across a frequency band, FMCW systems are more susceptible to interference (e.g. in busy harbours).
- They have approximately 30% more components than pulse systems, and economies of manufacturing scale are not as large for FMCW as for pulse systems, so they tend to be more expensive.

and may be difficult to identify from the radar data alone. ‘Buddy checking’ of the radar data using information from a supplementary pressure sensor may help to spot when these events occur. As regards more permanent objects in the radar beam, Section 4.5 describes how some manufacturers provide software that allows parameters to be set so as to blank off unwanted strong reflections within a certain range of distances.

Other Material in the Beam

Radar will not provide a measure of the real water surface when sea ice is present during winter months. In these cases, the radar gauges will require supplementing with other techniques such as pressure measurements. Sites where foam is often present will not be ideal for radar gauges as foam absorbs the transmitted pulses. Factors such as air turbulence, dust, fog, rain and water spray are not likely to cause problems with low frequency (10 GHz or 3 cm wavelength) radar but might be expected to become more important at higher frequencies. For example, the attenuation of radar due to heavy rain increases from X to Ku and K-band and significantly affects Ku-band measurements of sea level by satellite altimetry (e.g. Quartly et al., 1996; Wikipedia, 2015b). However, this will not be a major factor for the short ranges measured by radar tide gauges.

Waves

In principle, one would like to sample sea level fast enough (say at 1 Hz or faster), so that a measurement averaged over the timescales that we are interested in (e.g. 1 minute) would filter out the variability in level due to waves (waves having periods of several seconds for wind waves to approximately 20 seconds for swell). This is an example of ‘temporal filtering’ of waves, instead of the ‘mechanical filtering’ provided by a stilling well for a float tide gauge, and would be akin to the rapid sampling provided by pressure sensors. Many of the radar devices in Appendix 1 indeed work this way.

However, a concern is that waves could contribute to radar measurements of sea level in ways other than as a form of high-frequency noise that must be filtered out, but could also result in a systematic bias in the measurements. Many sea level scientists have experience of measuring sea level using radar altimeters on satellites. The accuracy of altimeter sea level measurements is known to be dominated by that of the sea state bias correction. This can be expressed as the sum of two terms: the ‘electromagnetic bias’, which arises because of

greater backscattered power per unit surface area from wave troughs rather than wave crests; and the ‘skewness bias’, which stems from the difference between the mean and median scattering surfaces (e.g. see chapter 9 of Pugh and Woodworth, 2014).

It should be no surprise therefore if sea level measurements using radar tide gauges are also affected by waves in some way. Most experience so far with these sensors has been limited to harbours and other sheltered coastal locations where there is limited fetch and a low-wave environment (average significant wave height nominally less than 1 m). There is some experience at coastal locations where there are higher waves. For example, Boon et al. (2012) estimated the error of measured sea levels to increase quadratically with wave height at an exposed location on the US east coast. However, Park et al. (2014) pointed to an issue with identifying the effects of waves on radar measurements in high wave energy environments, in that waves will also have effects on the reference sensor (e.g. acoustic or pressure) to which the radar data are compared. It is to be expected that radar gauges will be used at more locations exposed to high waves in the future, including at many remote ocean islands, partly because such locations may be difficult to access and radar gauges require relatively little maintenance. Therefore, more understanding of how waves effect radar gauge measurements is an important question for this Manual to address.

2.3 Radar Gauges in GLOSS

A requirement for a tide gauge in GLOSS is for it to be capable of measuring instantaneous sea level to better than 1 cm at all times (i.e. in all conditions of tide, waves, currents, weather etc., see Chapter 5 and IOC, 2012). An important question addressed by this Manual is whether radar gauges are capable of meeting this requirement as well as, or better than, other technologies.

In fact, there is over a decade of experience by various groups in operating radar gauges, and some groups have undertaken comparisons between different radars, or between a radar gauge and other techniques (e.g. Woodworth and Smith, 2003; Martín Míguez et al. 2008a, 2012; Pérez et al., 2014). Their publications are included in the References (shown in *italic* if they have not been mentioned explicitly in the Manual itself). However, to our knowledge, there has never been so far another comprehensive comparison of different radar gauges, such as the study performed some years ago between

seven tide gauges (3 radars and 4 other technologies) for almost two years at Vilagarcía de Arousa in NW Spain (Martín Míguez et al., 2005). That particular study concluded that for GLOSS purposes (e.g. when higher-rate data from each gauge were averaged into hourly values, or even when averaged into 5-minute values in most cases), all techniques could be considered equally suitable. In comparisons of sea level time series recorded by pairs of gauges, greater consistency was demonstrated by the three radar gauges.

The fact that radar gauges are a relatively new technology has not stopped many groups from investing in large-scale radar deployments in their networks. This is not surprising as, from a management perspective, they have many advantages over earlier technologies, including their comparative ease of installation and the fact that, in general, radar gauges are highly reliable and can be used maintenance-free for some years. Radar is a 'non-contact' technique, with nothing in the sea itself that could corrode or suffer damage, and without moving parts as in a float gauge. In addition, from a measurement perspective, they present advantages over other technologies. For example, radar is not affected by the atmosphere between the sensor and the sea, as in an acoustic gauge, and does not suffer from instrumental drift, as in a pressure gauge.⁶

Therefore, many groups have purchased radar gauges 'off-the-shelf', connected them 'plug-and-play' to data loggers and telemetry equipment, and begun delivering streams of numbers. Gauges operated by the groups we know of are listed in Appendix 1 together with some of their product details. Further information on each product is to be found in manufacturers' technical specifications, although sometimes that information is not as informative as one would like. All the radar devices mentioned in the International Hydrographic Organization inventory of tide gauges in Member States in October 2015 are included in this Appendix. (The Appendix is not intended to be exclusive and an entry should not be considered as an endorsement by GLOSS. Similarly, a gauge that is not included should not be assumed to be unsuitable for GLOSS. Approximate costs for each device are not listed as costs will vary between

6 The low power microwave signals of radar gauges are generated using components such as Gallium Arsenide (GaAs) field-effect transistor oscillators and monolithic microwave integrated circuit techniques that are not believed to drift, although there appears to have been no formal publications to support this (Peter Devine, private communication).

countries, and the manufacturers should be approached for up-to-date information.)

The frequencies employed span the approximate range 6-26 GHz (roughly 5-1 cm wavelength). Most of them are pulse systems with horn antennas for which the horn width, for a given beam width, is roughly proportional to 1/frequency. Therefore, these gauges all use the upper end of the frequency range. Examples of devices with different antennas for focusing the radar beam are those of the Miros (patch planar antenna), OTT RLS (separate flat plate antennas for transmission and reception), VEGAPULS-61 (encapsulated antenna) and Rosemount Waveradar Rex (parabolic antenna). The Krohne BM-100 and VEGAFLEX-81 do not transmit from an antenna into the open air but use vertical rods or cables as the waveguide (Section 4.3).

Higher frequency corresponds to shorter wavelength. Therefore, the 26GHz devices might be expected to be more accurate. However, higher frequency also means they will be noisier and more prone to false reflections. The FMCW gauges tend to use frequencies at the lower end of the range.⁷ There is evidence from Appendix 1 that some products are derivatives of others, having similar frequencies and general characteristics. (The similar frequencies are to some extent determined by international standards and licenses, see Brumbi and Van Zyl, 2009).

The pros and cons of pulse and FMCW systems are summarised in Table 2.1.⁸ However, there does not appear to be a single deciding factor between them for sea level monitoring. Pulse systems can be seen from Appendix 1 to have lower overall power requirements than FMCW devices as their higher peak power is transmitted during only a small percentage of the time. That makes them more suitable for operation in remote locations where only power from solar panels is available. They also tend to be

7 The choice of frequency owes a lot to historical technical development, the availability of common frequencies in different countries, and national and international standards. It seems that most FMCW devices have followed from an original SAAB standard at X-band around 10 GHz. The first pulse radars were also at lower frequencies (e.g. C-band around 6 GHz) while K-band around 26 GHz is a relatively new development (Peter Devine, private communication). At the time of writing we understand that an 80 GHz sensor has become available (the VEGAPULS-64) which is claimed to be insensitive to foam and water vapour but which, so far as we know, has not yet been tested for sea level measurements.

8 This table is based on information from <http://siversima.com/>, <http://www.endress.com/> and Øistein Grønlie (private communication).

less expensive than FMCW devices. That is partly because FMCW devices are more complicated than pulse systems (e.g. requiring sophisticated Fast Fourier Transform signal processing) and so have greater power requirements, although those requirements are now much lower than in FMCW devices a decade ago. FMCW devices could be thought to be more accurate than pulse systems in general because of their continuous transmission and their ability to measure a difference between transmitted and received frequencies accurately (the difference normally being in the kHz range). However, it is only by comparison between the various radar devices and other technologies that one can estimate how well they work in a GLOSS context. The present Manual is intended to provide some of that essential information.

2.4 Wave Measurements at GLOSS Sites

The measurement of waves has never been an objective of GLOSS, which has focused on the sea level changes that occur on timescales of minutes, hours and longer. Many GLOSS sea level stations are located in harbours, where wave heights are smaller than those outside, and one wonders how useful wave information at those locations would be in practice. Even when a tide gauge is located outside a harbour, it is inevitably in shallow water inside of where waves break.

The ends of long piers or off-shore structures such as oil platforms provide more suitable locations for wave measurement. For example, Blasi et al. (2014) undertook experiments at two off-shore platforms in the German Bight using an array of four 26 GHz pulse sensors, separated by approximately 3.5 m and sampling at 2 Hz. They were able to determine wave heights together with directional wave information by means of cross-covariance analysis of the individual radar sensor measurements.

Nevertheless, some groups do have an interest in attempting to record waves at the coast itself as a complement to off-shore measurements. This has hitherto been possible at a tide gauge station by using pressure sensors (e.g. Vassie et al., 2004). Alternatively, Park et al. (2014) have measured wave spectra by examination of the noise in 1 Hz acoustic and pulse radar gauge data (the latter using the Waterlog H-3611 sensor); similar findings were obtained for the two techniques but the radar had a higher sensitivity to waves and therefore a higher fidelity for significant wave height estimation.

Most sensors marketed explicitly as both tide and wave recorders (from Miros, Rosemount and Radac) are FMCW instruments. The Spanish REDMAR network uses Miros FMCW gauges to make local wave measurements inside harbours (or at their entrances) to validate wave models and for harbour operations. Good experiences of such measurements have been obtained (Pérez Gómez, 2014; Pérez et al. in Supplement). A review of radar wave measurements, with a focus on the Rosemount Waveradar Rex, including theoretical simulations and comparisons to buoy data, is given by Ewans et al. (2014).

2.5 Summary on Radar Gauges for GLOSS

In summary, radar gauges appear to provide a cost-effective choice of technology for new or refurbished sea level stations in GLOSS. They offer many advantages regarding installation and maintenance. In addition, the set of potential sources of radar measurement error discussed above seems to be rather a short one, compared to the sets that could be made for other technologies. As a result, the GLOSS Implementation Plan (IOC, 2012), its various reports (IOC, 2006) and its workshops have all recommended that new stations be equipped with a robust gauge such as a radar to serve as a primary sea-level sensor complemented by a pressure gauge serving as the primary tsunami sensor.

However, there are some caveats about radar gauges. Experience with them so far has been limited, and new problems may become evident after several more years of operation. In particular, there are concerns about the calibration of the devices (their effective datum) and the effects of waves on the measurements. These aspects have to be researched fully by means of comparison of gauges over different sampling periods by different techniques and in different environments. Other disadvantages include their potential exposure to damage during major storms or tsunamis, including the possibility that the water level in such events may even exceed the height of the radar sensor, and the further possibility that floating debris or boats may pass under the beam resulting in false measurements.

In spite of these limitations, it seems that radar gauges will be installed by many national agencies, so it is important that we understand as much about them as possible. However, it is not suggested that radar should automatically replace other techniques, especially where the latter have worked effectively for many years.

3. Experiences with Radar Gauges including Intercomparisons with Other Technologies

This chapter summarises what is known about using radar gauges for sea level monitoring, based on the published literature, and on the contributions describing recent experiences of radar gauges included in Supplement. These sets of information have been used to draft the recommendations for acquiring and installing new radar gauges included in Chapter 4.

Early Publications

The suitability of radar sensors for monitoring sea levels was first investigated seriously in the early 2000s. At this time, they were something of a novelty, and the main concern was whether the radars could measure fluctuations in sea level that were comparable to those obtained by existing tide gauges. Therefore, Woodworth and Smith (2003), Shirman (2003), Eberlein and Liebsch (2003) and Martín Míguez et al. (2005) largely focussed on the standard deviation of the differences between the radar and other (e.g. float or pressure) sea level measurements. There was little or no discussion of the effective zero of the radar gauges (i.e. Sensor Offset, discussed in Chapter 4). In addition, while the possibility of wave bias on the radar measurements was recognised, it was not researched in detail, the measurements anyway being made in generally low wave environments. However, these early comparisons succeeded in demonstrating the potential of radar sensors for sea level measurements, and they suggested that radars could meet the accuracy requirements for GLOSS. In some cases, the comparison exercises were particularly interesting in using the radars to identify previously-unappreciated problems with the earlier technologies.

Publications 2008-2012

This period saw radar gauges employed by more groups around the world for long-term sea level monitoring. In particular, large investments in radar gauges were made in Spain, partly in response to new monitoring requirements for their harbours following the Sumatra tsunami in 2004, and largely informed by the findings on comparisons between gauges by Martín Míguez et al. (2005).

In France, Martín Míguez et al. (2008a) concluded that horn antenna and guided wave radars in stilling wells provided data consistent at the cm level with information from conventional float gauges, and, as a consequence, they concluded that radar was an acceptable technique for GLOSS. Martín Míguez et al. (2012) also tested the stability of a radar gauge at a remote location (Kerguelen Island), by comparison to tide pole and pressure measurements, finding the radar to have a measurement error of several mm and with no significant drift. Radar gauges have since been deployed extensively within the French sea level networks. In India, Mehra et al. (2009, 2012) undertook comparisons between radar and other technologies over approximately one year and found acceptable agreement, although with the main aim of validating the pressure, rather than radar, data (see also Mehra et al., Supplement).

Comparisons were also made by the hydrological community between the several different types of radar gauge, as well as between radars and older techniques. For example, Fulford et al. (2007) compared data from three types of radar sensor to that from a float gauge at a lake in Arizona, finding similar measurement precision for all devices, but with some sensors having systematic offsets. They found little evidence for radar data being affected by waves.

Experiences in this period can be summarised as confirming that radar can monitor sea level variability at most locations as well as other technologies. However, there was little further insight obtained on possible systematic errors in radar data, in what environmental circumstances radar accuracy would be reduced (e.g. the presence of waves), and in the most extreme cases, where radar data would be unacceptable. Radar gauges seem to have been installed at many sites, without any comparison tests at all, and with an assumption that they will work perfectly.

NOAA Comparison Studies

This period included the start of a set of technical studies by the National Oceanic and Atmospheric Administration (NOAA), using radar gauges from different manufacturers and comparison data from the Aquatrak acoustic gauges

that had hitherto been the standard technology in the US network. The References section of this Manual lists a number of their reports, which reflect the lessons learned with the new technology as experience was gradually acquired over several years. This comprehensive set of studies contrasts with the more superficial investigations, or no investigations at all, undertaken by other countries, and NOAA findings have been important in informing this Manual.

Heitsenrether and Davis (2011) is one of their main reports. It summarised the reasons for the selection of a particular sensor (Waterlog H-3611) from the four sensors considered. It stressed the importance of knowing the Sensor Offset for individual instruments, a topic discussed at length in Chapter 4. Agreement between radar and acoustic 6-minute data, and between average values over longer periods, had been found to be at the cm level or better, for semi-enclosed coastal sites with low wave environments. Therefore, the report recommended limited acceptance of radar at such sites. It left open for further research the question of radar acceptability at more exposed, high wave locations, where the effects of waves on the radar were difficult to decouple from large wave-related signals in the comparison data set from the acoustic gauges (Park et al., 2014).

The choice of a particular sensor led on to the design of a standard mounting collar and support frame which could be adapted for use at several 100 installations with minimal modifications at each site. These aspects are also mentioned in Chapter 4. Parallel studies included selection of optimum low-pass filtering of high rate (1 Hz) data, inevitably noisy in the presence of waves, to improve the accuracy of 6-minute sea level data (Boon, 2014). While waves were found to lead to larger uncertainty in sea level measurement, there was little evidence in this set of studies for a wave-induced bias in sea level.

Recent Publications to 2016

By this time, some groups had acquired many years of data at stations equipped with both radar and older technology gauges. For example, Pérez et al. (2014) (see also Pérez Gómez (2014) and the paper by Pérez et al., Supplement) reported on the lessons learned in Spain as older acoustic gauges were gradually replaced with radar sensors at 17 sites. This study compared old and new data sets in different frequency bands, taking into consideration possible scale errors and time shifts in both sets (but mostly in fact in the older data), with emphasis

on the quality of long-term information in combined data sets when one technology is replaced by another. Of particular concern was the impact on data quality of delamination problems in the new radar antennas.

Contributions in Supplement

The contributions in the Supplement demonstrate the importance that many groups associated with GLOSS attach to this new technology. They show, as above, that radar has many advantages over other techniques and can in many cases provide data of suitable quality for GLOSS. However, best practice dictates that one points to the circumstances in which data of different quality are obtained, and to specific problems using radar.

It is possible that some of these problems could be specific to a particular sensor and/or to the local environmental conditions. That means it may be difficult to arrive at general conclusions regarding whether some sensors are better than others. Nevertheless, the community is large enough that more than one group is likely to have experience of a particular sensor, and one hopes that the sharing of experiences will eventually resolve many of the specific issues.

Some of the main conclusions from the experiences described in Supplement include:

- ✓ **Australia** (Queensland): the Coastal Impacts Unit (CIU) observed wave bias effects in S-band radar (VEGAPULS-61 or 62) data although whether they should be considered real or not is difficult to establish without comparison to data from other (non-radar) sensors. The spikes in S-band radar time series are much reduced in the corresponding time series from a C-band sensor (VEGAPULS-66). C-band is also used extensively in Japan (Tokyo Keiki MRG-10), and Oman (Sutron RLR-003).
- ✓ **Caribbean:** NOAA (USA), University of Puerto Rico and the Institut de Physique du Globe (France) describe how radar is now used at approximately half of the 68 sea level stations used for tsunami monitoring in the Caribbean, thanks to the efforts of the University of Hawaii Sea Level Center (UHSLC) and other contributors to the network. No major differences have been observed between particular types of radar (guided wave or open air) from the perspective of tsunami monitoring, and radar gauges have been shown to be resilient and cost effective. However, sufficient data has now been collected that a much

more in-depth study of their performance is merited, including investigations into their suitability for long-term mean sea level monitoring in the region.

- ✓ **Chile:** the Hydrographic and Oceanographic Service of the Chilean Navy (SHOA) reports acceptable performance of VEGAPULS-62 sensors in their 40-station network. They stress the importance of pressure sensors as a back-up and complementary sensor to the radar. Their experiences of comparisons between radar and pressure gauges, exhibit variable results depending on the exposure to waves. The results demonstrate the reliability of the radar sensor at sheltered sites, whereas at sites exposed to wave action, data should be used with caution if they are intended for scientific purposes, despite the fact that the radar sensor is sampling at 4 Hz.
- ✓ **France:** the Service Hydrographique et Océanographique de la Marine (SHOM) has a wide range of experience with open-air horn antenna and guided wave radar systems (all from Krohne) with generally excellent performance. Most tide gauges are subject to both physical (stilling well) and temporal filtering of the data. Some stations are open-air without mechanical filtering. No major wave bias effects have been reported.
- ✓ **Germany:** the Bundesanstalt für Gewässerkunde (BAFG) describes how studies of radar gauges for sea level, sea state and ice cover measurement have been made for more than a decade at test sites in the North Sea equipped with gauges based on other technologies for comparison. The present report focusses on the accuracy of measurements of sea level. The analysis reveals that the uncertainty of radar sea level measurements increases linearly with the wave height and does not depend on wave period. Future work is planned that will focus on advanced filtering techniques for radar measurements similar to those undertaken by Boon (2014).
- ✓ **Germany:** the Bundesamt für Kartographie und Geodäsie (BKG) reports acceptable performance of VEGAPULS-61/62 sensors as summer tide gauges in Antarctica. They point out that data become noisier during high wave events but that the noise does not appear to affect mean values and can be removed by temporal filtering.
- ✓ **India:** the National Institute of Oceanography (NIO) provides references to previously published comparisons of radar (mostly OTT Kalesto) to other gauges and describes how, since the December 2004 Indian Ocean tsunami, the NIO has developed a near real-time reporting integrated coastal observation network providing sea-level, sea-state and surface meteorological information at coastal and island stations.
- ✓ **Japan:** the Japan Meteorological Agency (JMA) undertook comparisons between a Tokyo Keiki MRG-10 radar gauge (5.8 GHz) and a float gauge in the same stilling well in Tokyo for 21 months, and concluded that there was agreement within 5 mm, consistent with their requirements. Subsequently, a similar arrangement was used at 44 tide gauge stations, with the radar beam polarisation and programming optimised to ignore reflections from obstructions in the individual wells. The evident success of this low frequency (C-band) radar, with a wide opening angle (17°) in a stilling well, is an important result with regard to adapting radar for use at existing stations.
- ✓ **South Africa:** the South African Navy Hydrographic Office (SANHO) reports acceptable performance of OTT Kalesto and RLS sensors, subject to in situ range calibration.
- ✓ **Spain:** Puertos del Estado reports that the Miros SM-94 monitoring at 2 Hz provides a more precise and stable measuring system than the acoustic and pressure gauges used previously. Initial problems with delamination of several antennas have been solved. New and rigorous laboratory and in situ protocols for periodic range calibration and sensor testing have been designed. Wave activity does not affect hourly sea levels, tides and monthly means. However, it may affect individual (1 min or higher frequency) sea level measurements, and therefore extreme sea levels, at those stations in the REDMAR network with a higher wave environment. These wave effects are not yet perfectly understood. For one thing, it is not easy to distinguish the instrumental noise or bias from other local effects such as wave setup. In addition, during the inter-comparison experiments, the effect of waves on the sensors used for comparison in the same harbours are not well known either; this conclusion is in accord with that obtained by NOAA.

- ✓ **UK:** Channel Coastal Observatory describes the use since 2006 of Saab (now Rosemount) WaveRadar REX gauges at 5 sites on the south coast of England. The instruments are programmed to log at 4Hz, subsequently averaged for 2 minutes every 10 minutes. In addition, a down-sampled 1Hz signal is averaged to 5s and forwarded to the IOC SLSMF. Waves are also measured, derived spectrally from a 30 minute burst at 4Hz, every 30 minutes. Three of the 5 sites are subject to wave action and considerable de-spiking etc. is needed in the processing software. An average over 480 records produces a robust value for tide measurements, but for wave processing care must be taken to remove the outliers without reducing the observed wave energy. No instrumental drift has been observed in the 10 minute time series. In addition, there appears to be no systematic bias due to waves in producing either higher or lower water levels. They conclude that the WaveRadar REX is a robust and reliable device with low maintenance costs.
- ✓ **UK:** the National Oceanography Centre (NOC) describes methods for calibration of various radar gauges both in the laboratory and when installed. The necessity for range calibration (preferably prior to installation) in practical cases at several sites in the South Atlantic is emphasised. Comparisons have been undertaken of radar data to those from pressure gauges at the South Atlantic sites. These have identified wave-related biases in Waterlog H-3611 data and OTT RLS data which are not well understood. However, in lower energy environments, such as Port Stanley, the Waterlog performance is acceptable, again subject to range calibration prior to installation.
- ✓ **USA:** NOAA reports adequate performance of the Waterlog H-3611 in low to medium wave environments, subject to rigorous range calibration and sensor testing prior to deployment and high rate (1 Hz) measurement. In medium to high wave environments, smaller wave effects on sea level measurements have been observed than for the acoustic-stilling well gauges that are due to be replaced across the network.
- ✓ **USA:** the US Geological Survey (USGS) were satisfied with the accuracy of older technologies (float and pressure) for inland water level measurement. However, the non-contact advantages of radar gauges were recognized as important factors for installation and maintenance. Early tests used FMCW

devices with SDI-12 readout (e.g. DAA H-360). A temperature dependent bias was observed in the measurements. Comparisons to float or bubbler measurements were inconclusive due to data from the reference gauges being smoothed relative to the radar information. However, it was encouraging that radar data corresponded more closely to individual wire-weight gauge measurements than bubbler data. Later tests involved pulsed radars with SDI-12, which were found to be more accurate and to have lower power consumption than the FMCW devices. Range measurements by the DAA H-3611 showed no trend in bias as a function of range itself, while the VEGAPULS-62 did present a trend in range bias. No effects of waves or diurnal temperature effects were noticed for either. However, laboratory tests showed that default settings resulted in under-measurement of the water level in some wave conditions. Because of the general good performance of the H-3611, it has since been employed throughout the USGS. Insect and condensation problems with the horns were largely solved. However, enclosed antenna models (OTT RLS and DAA H-3613) were found to eliminate most of the antenna problems completely. Some issues have since been noticed, including a diurnal cycle bias in measurement due to possible temperature effects, and jumps in data suspected to be caused by wind waves, and effects due to ice and objects in the beam. They conclude that radar may not be appropriate for all sites. However, experience has shown that radar sensors can be used at many sites to provide water-level measurements with accuracy similar to or better than that of the older techniques, and with the additional non-contact advantages.

We can summarise these findings as follows:

- Radar has been found to be an acceptable means of measuring sea level subject to considerations of range calibration, high-rate sampling and data filtering. Some groups now have considerable experience of using radar gauges in large networks and over extended periods and they have been found to work well.
- All groups in effect identify that noise is not a problem in high rate radar measurements as filtering can remove most of it. However, it is essential to sample at as close to 1 Hz as one can, or faster if possible, with the sensor configured to operate in fast (e.g. 1 second) response time mode. Noise can be removed either by

‘mechanical filtering’ in the design of the tide gauge system or by subsequent off-line ‘temporal filtering’.

- There are no criteria, such as accuracy, that would lead to a preference for pulse over FMCW radars, or vice versa. However, there are pros and cons for each type which may be important considerations in each situation (Table 2.1).
- Waves remain a potential problem with some sensors at some sites and their effects need to be better understood. There are situations in which radar gauges do not work well, and the problems in these cases are usually related to waves. In such situations, users should investigate the use of other tide gauge technologies.
- There is little theoretical work on the effect of waves on radar interactions with the sea surface and the changes in recorded sea level that result.
- The use of C-band sensors, instead of the more common S-band devices, which might suppress biases due to waves, has given encouraging results in Australia and Japan that should be researched further.
- Most groups agree that ancillary pressure sensors are desirable alongside the radar gauges.
- There is no general recommendation to be made as to a preferred radar gauge manufacturer. Cost will clearly often be an issue in the selection of a manufacturer, but even more important issues for programmes such as GLOSS are whether the selected gauges are well calibrated and whether wave effects are understood. Groups which find difficulty in selecting a manufacturer should consult one or more of the organisations represented in Supplement.
- There is interest by many groups in undertaking a future set of detailed comparisons of the performance of different radar gauges operating at the same site (or perhaps several sites with different wave conditions). GLOSS would be an appropriate programme in which to organise such tests.

4. Radar Gauge Installation

4.1 The Choice of a Tide Gauge Site

The factors associated with choosing a tide gauge site mentioned below apply to all types of gauge, not only to radar gauges. Sometimes a gauge may be required for a particular application and it is clear where it has to be located. For example, a gauge required for harbour navigation has to be operated in the harbour itself, or a gauge installed to provide insight into a local process such as coastal erosion needs to be located near to where the process occurs. However, at other times there may be several possibilities for a gauge's location on a particular section of coast that need to be judged according to various criteria. For example, for selection as a GLOSS Core Network site one would normally want a gauge located with maximum exposure to the open ocean, rather than be situated in a river estuary. Whatever the application, it will be important to consider many of the following factors.

General requirements are:

- A suitable tide gauge site should be selected that is connected by relatively deep water to the open sea, so providing sea level information that is representative of that part of the ocean.
- The site must be adjacent to water that experiences the full tidal range and does not dry out at low tide.
- For example, if a stilling well is to be used, there must be at least two metres depth of water at Lowest Astronomical Tide (LAT). Its outlet should be clear of the sea bed and be set deep enough to allow the float to operate about one metre below LAT. If a radar gauge is used, the water must always be deep enough so that rocks are not exposed by waves at low tide.
- There must be adequate means of access for installation and maintenance.
- There should be a suitable tide gauge hut or storage container as close to the gauge as possible, that can contain all of the gauge's electronic equipment. Any hut should not be accessible by the public and it must be secure from vandalism and theft.

- There must be continuous mains power or storage batteries/solar panels (or both in the case of tsunami stations) and telephone or satellite access for near real-time data transmission.
- The surrounding area should be 'stable' as far as possible and ideally an installation should be on solid rock. The area should not be liable to subsidence because of underground workings, from being reclaimed land, prone to slippage after prolonged rain (i.e. the area must be adequately drained), or likely to undergo erosion from the sea. As a result, the local area must be suitable for the establishment of a benchmark network for geodetic control. The marks, in particular the Tide Gauge Bench Mark (TGBM) and GNSS Bench Mark (GNSSBM), must be safe from accidental damage.
- The station should be equipped with an inexpensive tide 'pole' or 'staff' to guard against gross errors in the datum of the sea level information recorded by the gauge, even if the gauge itself uses the most modern technology.
- The installation must be capable of withstanding the worst environmental conditions (winter ice, storms etc.) likely to be encountered. This may affect the choice of gauge technology to be used. Positions exposed to environmental extremes should clearly be avoided to enable the eventual accumulation of a long time series of sea level data.
- If stilling well or acoustic gauges are to be installed, then the stilling well or acoustic tube must be tall enough to record the highest sea levels. This may require permission from port authorities if, for example, the installation is on a busy quayside.

Places to avoid are:

- River estuaries where estuarine river water can mix with sea water to varying extents during a tidal cycle and at different times of the year, resulting in fluctuations in water density. This may have important impacts on float gauge measurements in stilling wells because of 'layering' of water drawn into the well at different times causing a difference in density inside and outside the well. It will also

impact on pressure measurements, as the density assumed for the conversion of pressure to sea level will not be constant. Currents associated with river flow can also cause drawdown in stilling wells and in the stilling tubes of acoustic gauges. Following heavy rain-storms, debris floating down-river could damage a gauge.

- Locations affected by strong currents or directly exposed to waves which can have local effects on sea level.
- Locations near outfalls that can result in turbulence, currents, dilution and sediment movement.
- Locations in a harbour where there can be local oscillations or which experience swash e.g. in a corner where two quays meet.
- Locations where shipping passes nearby. At these locations, ships could induce short-lived but large high-frequency sea level oscillations, collision damage could occur, propeller turbulence could cause silt movement (most relevant for stilling wells), and boats passing or moored beneath a radar gauge would result in a loss of data.
- Locations where construction work is likely in the near future that may either affect the tidal regime (e.g. by construction of new quays or breakwaters) or necessitate the relocation of the tide gauge, thus interrupting the sea level time series.
- Locations where impounding (isolation from the open sea) occurs at extreme low-tides should be avoided. Or where rocks are just below the surface that could be exposed during high wave periods. Similarly, sandbars located below the surface between the site and the open sea can result in uncharacteristic levels being measured, that can vary as the positions of the sandbars change.

Additional factors to be considered when changes in gauge location are inevitable:

- When a gauge is moved a short distance, perhaps because of harbour developments, then levelling between the benchmarks at the two sites should in most cases enable the sea level time series to be continued as if it was one record.
- However, if a gauge is moved some distance along a coastline, one has to consider that there could be a difference of MSL (relative to the geoid or 'level

surface') between the two locations due to ocean dynamics (geodesists call such a variation in MSL the 'mean dynamic topography'). MSLs at one site may be higher or lower by several centimetres, compared with the corresponding levels a few kilometres away along the coast, or outside rather than inside a harbour. These differences mean that the two time series cannot be combined as if they were one record.

- A good example is movement of a gauge some distance within a river estuary. There will be a systematic difference between the long-term MSL observed at the two locations because of the spatial variation in density. This will be hard to quantify (and so to adjust for) without detailed oceanographic measurements and modelling. In addition, there will be changes in the seasonal cycle of sea level.
- Another example concerns moving a gauge installed near a sharp headland to another location along the nearby open coast. Since headlands are places where large tidal currents tend to occur, that can result in a lower MSL (relative to the geoid) than at the second site, there will be a systematic difference between sea level measured at the two locations. Similar considerations apply to pairs of gauges inside and outside harbours with restricted entrances.

In summary, the general principles should be to make an informed initial selection of tide gauge equipment for use at a good site that has every likelihood of being a permanent installation.

From the special perspectives of siting tide gauges for tsunami monitoring, an Australian Bureau of Meteorology report is available which contains further advice. Aside from the requirement to site gauges so as to have the shortest possible arrival time, most of their criteria in fact apply to the siting of gauges in general (Warne and Brewster, 2014).

4.2 Suitable Radar Gauge Locations

General aspects to consider when reconnoitering a possible site for a radar gauge installation:

- Go through the many general requirements for a tide gauge site given above.
- Take as many photographs of the site as possible from different directions (e.g. two sets in opposite directions along the water edge, one set looking out

Table 4.1

Pros and Cons of Different Radar Gauge Mountings

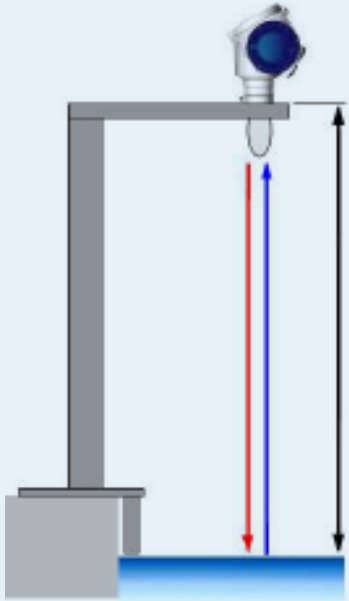
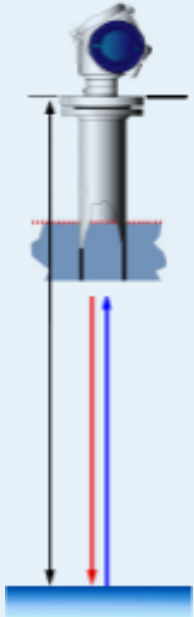
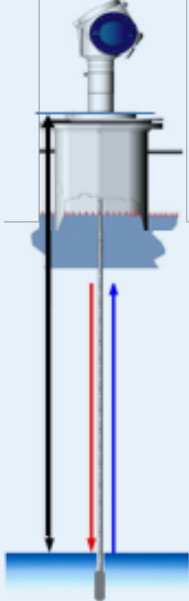
Non-contact radar in open air (Pulse or FMCW)	Non-contact radar in stainless steel stilling well	Guided Wave Radar (GWR) in stilling well
		
<p>Pros :</p> <ul style="list-style-type: none"> - Easy, quick and cheap to install on support arm above the water - Does not need a vertical quay - Can be installed under a bridge for sea level and/or airgap measurements - Some sensors allow wave measurements - No contact with sea surface means much less maintenance. 	<p>Pros :</p> <ul style="list-style-type: none"> - Because diameter of the new tube is much smaller, can be installed inside an existing stilling well to replace an historic float tide gauge. - Can be installed along a vertical quay - Stainless steel tube is used both as a stilling well and as a wave guide so signal power attenuation is limited and range measurements can be extended to 15-20m. 	<p>Pros :</p> <ul style="list-style-type: none"> - Can be installed inside an existing stilling well to replace an historic float tide gauge. - No need for extra tubes when instrumenting an existing stilling well. - Can be installed along a vertical quay inside a 20cm diameter PVC tube that is less expensive than stainless steel tubes.

<ul style="list-style-type: none"> - Ideal for long periods of observation (years) - Records high-frequency oscillations 	<ul style="list-style-type: none"> - Sea level measurements are less noisy because of mechanical filtering by the stilling wells and protection by the well against sea spray. - Calibration dipping measurements are easier and accurate thanks to the still sea surface. - No contact with sea surface means very much less maintenance 	<ul style="list-style-type: none"> - Sea level measurements are less noisy because of mechanical filtering by the stilling wells and protection by the well against sea spray. - Calibration measurements are easier and accurate thanks to the still sea surface. - Sea level measurement is less sensitive to signals from multipath reflections or secondary lobes. - Stainless steel cable is used as a wave guide so that signal power attenuation is limited and distance measurements can be extended up to 15-20m.
<p>Cons :</p> <ul style="list-style-type: none"> - Not suitable for large tidal ranges (> 10m) because of beam width results in a varying area of illuminated sea surface and over large ranges signal attenuation can be large. - Surface detection is sensitive to the environment (side lobe detection) and multipath signals. - Surface detection can be disturbed by echoes from sea spray. - Boats or floating objects can occur under the beam. - Calibration checks using dipping or tide pole measurements are not easy and less accurate because of the wind and choppy seas. 	<p>Cons :</p> <ul style="list-style-type: none"> - Expensive because of the implied infrastructure including : <ul style="list-style-type: none"> • an 8cm diameter stainless steel tube as a wave-guide. • an additional 8cm diameter PVC tube for dipping measurements. - Needs an existing stilling well or a vertical quay. - Installation needs a crane to attach the tubes at low spring tide. - The bottoms of the tubes and stilling wells need to be cleaned regularly in case of silting. - High-frequency observations, which can be valuable for some scientific applications, are filtered. 	<p>Cons :</p> <ul style="list-style-type: none"> - Also expensive because of the implied infrastructure including: <ul style="list-style-type: none"> • a 30cm diameter PVC tube for radar and dipping measurements. - Needs an existing stilling well or a vertical quay. - Installation needs a crane to attach the tubes at low spring tide. - The bottoms of the tubes and stilling wells need to be cleaned regularly in case of silting. - The stainless steel cable needs to be regularly inspected and cleaned in case concretion appears along the cable. Such concretion slows down the wave propagation and thus affects the measurement by several cm in a way that is difficult to detect. - Sometimes the cable can lose its counterweight which requires regular checks to be made

to sea, and if possible one set looking toward the land from the sea). Good photographs are always needed for formal reports and manuals and the photographs should be taken as well as possible. At a location with a large tidal range, note the time of any photographs taken as impressions may well be different at extreme low tides. A video record would also be useful.

- Draw a map to supplement the photographs.
- Document all the local information e.g. names and contact details of pier owners.
- Remember that a main object of the exercise is to estimate how the gauge will best be mounted at the site so consider the pros and cons of different mounting possibilities (see next Section).
- If the most likely possibility is for a gauge to be mounted over the open water, check whether the sensor will have an uninterrupted view of the sea surface with little possibility of false echoes. Check for general boating and other activity in the immediate area. Measure distances from open water to the quayside and note any obstructions. Estimate the

likely maximum range of a radar measurement and the maximum size of the radar footprint and, therefore, whether the beam is likely to reflect from targets other than the sea surface. Check how long a cantilever arm needs to be made.

4.3 Radar Gauge Mounting

This section discusses the different types of mounting of radar gauges so that they have a good chance of delivering the best possible sea level data.

Radar Gauge Mounting over Open Water

A common choice of radar mounting has the gauge positioned over the open water, with the radar beam transmitted from the sensor to the sea surface and back without any wave guide; alternative mounting arrangements are described below. Aspects to be considered in this case are as follows:

- The gauge should be mounted over the water at a spot that never dries out, and does not have rocks or other obstructions that are exposed at low tide.

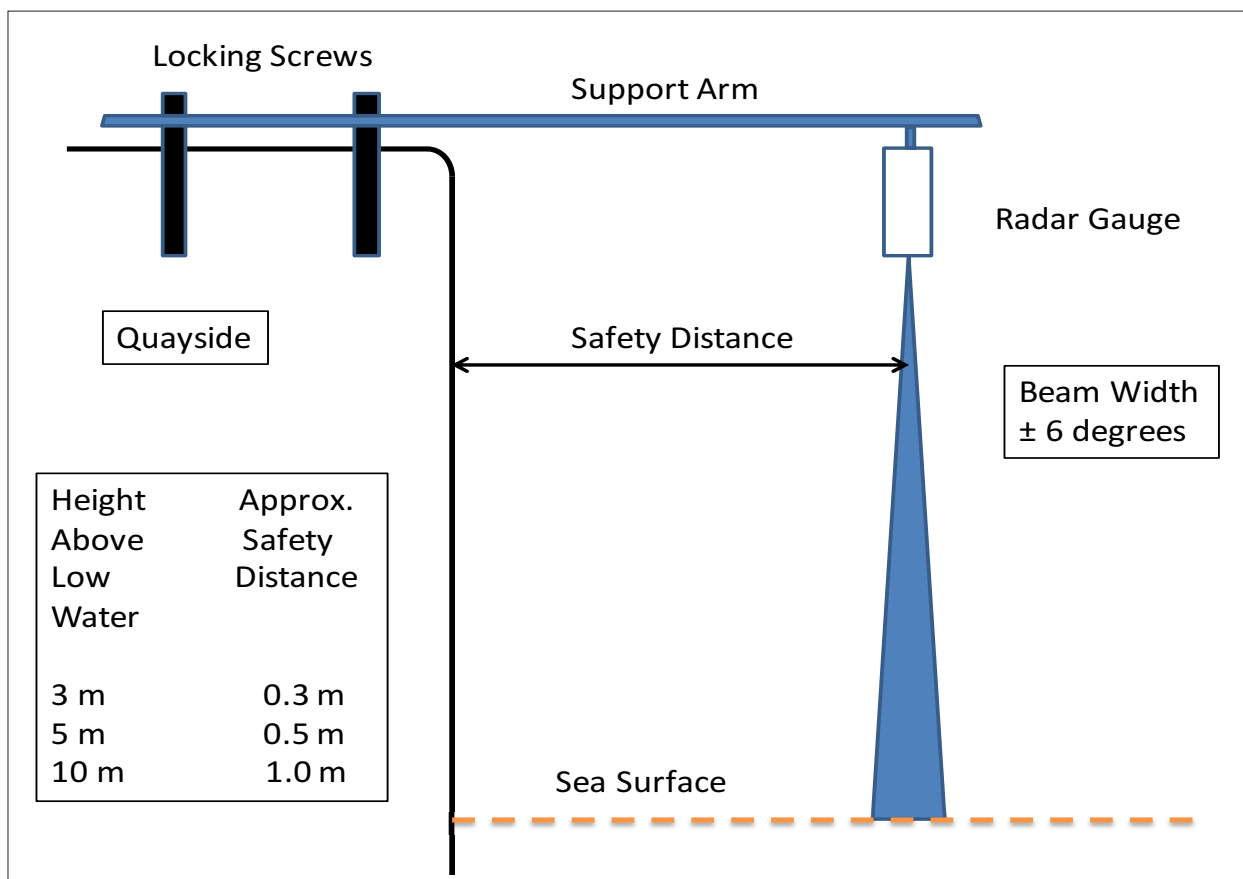

Figure 4.1 Schematic of a radar gauge with $\pm 6^\circ$ beam installed near to a harbour wall indicating the approximate safety distance.

- A mounting (e.g. a cantilevered arm) must be provided that is strong enough not to be affected by the maximum possible wind conditions, and that does not expand and contract with temperatures, so that a constant height of the gauge relative to benchmarks is maintained.
 - The angle of the beam should be aligned so that it is perpendicular to the water to within a tolerance specified by the manufacturer. It should not be in danger of receiving false reflections from a harbour wall or other supporting structures. The footprint of the beam will have a radius $R \tan(\alpha/2)$ where R is the range and α is the beam full-width. **Figure 4.1** provides an example of a gauge with a 12° beam full-width (0.1 radian half-width) indicating a minimum 'safety distance'.
 - The height of the sensor above the surface should be within the range specified by the manufacturer, and high enough so that the water will never rise to within a 'measurement dead zone' of the antenna. (This may be a difficult to achieve if the gauge is intended to monitor large storm surges or tsunamis that may potentially even overtop the gauge.)
 - The location should not be one where boats could be moored beneath the beam, or where vegetation or floating rubbish could accumulate (e.g. in the corners of harbours), resulting in false readings.
 - Radar gauges are designed to reflect off a water surface and not off ice. In polar areas, a different gauge technology might be preferable and a guided-wave radar in a heated stilling well may be an alternative (see below and Appendix 1). Alternatively, a radar gauge could be operated for the ice-free summer months to complement a permanent pressure gauge (see Kühmstedt and Liebsch, Supplement)
 - Similarly, sites where foam is present should be avoided as foam absorbs the transmitted pulses.
- Design aspects of the mounting should include:
- The mounting frame must be made of a material that does not corrode in the coastal environment (painted aluminium or structural fibreglass are suitable choices), and it must be designed so that when the gauge is attached to the end of the arm, the height of the gauge reference mark (that can be related via calibration to the effective zero range point of the sensor, see below) will be known with respect to another mark on the landward end of the arm. This relationship should be confirmed by assembling and measuring all the equipment in the laboratory prior to installation. The height of the reference steel mark with respect to benchmarks can then readily be determined by levelling between the landward mark and the local benchmark network.

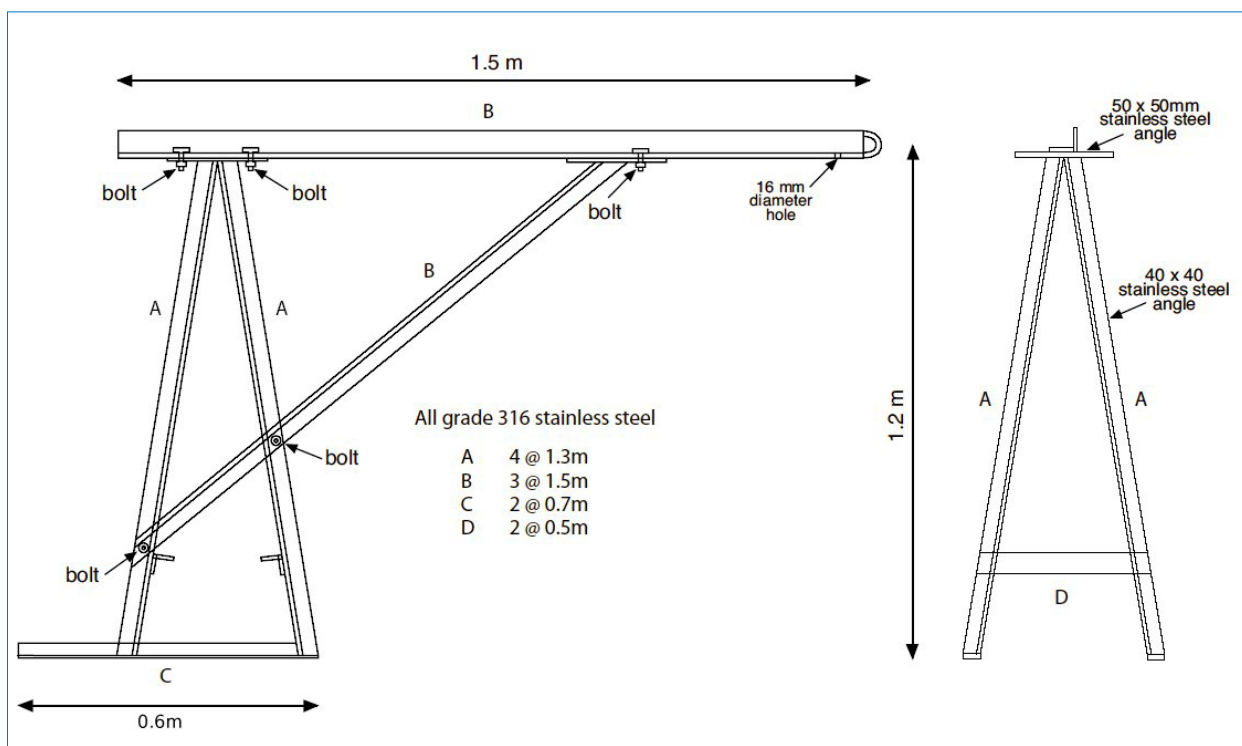

Figure 4.2 A basic radar gauge support frame as used at several stations in Africa and the Indian Ocean.



Figure 4.3 An OTT Kalesto gauge in Alexandria at the end of an arm that is pushed and bolted into place. (Photograph T. Aarup, IOC).

- The gauge may be placed in its operating position by attaching it to the end of a cantilever arm when both are on land, and then by sliding the arm out over the water. Alternatively, the arm may be designed to rotate about an axis such that its end is over land when the gauge is attached, then swung over the ocean for operations. In each case, the arm must be perfectly horizontal and firmly bolted. An essential aspect is that working with the arm (pushing or rotating), so as to move the gauge from its operating position to a point where it can be accessed for servicing (or vice versa), must not result in the gauge being reinstalled at a different height to previously. After reinstallation, the relative heights of the various marks must be checked. However, it would be best if the frame design itself prevented unintended changes in height occurring.
- (ii) An example of an arm that is pushed and bolted into place is shown in **Figure 4.3**. This installation is at Alexandria, Egypt and the arm is shown supporting an OTT Kalesto gauge.
- (iii) A similar arm to the Alexandria one, but that is rotated into place, is shown in Figure 3.6 of IOC (2006). That photograph shows an installation at Liverpool, UK with the arm supporting an OTT Kalesto.
- (iv) NOAA uses a special round collar for mounting a horn radar gauge in the field (e.g. a Waterlog H-3611). The collar is a 1-inch thick aluminium disk with a hole through which the horn is inserted, allowing the bottom of the sensor's circular flange to sit flush with the collar surface (**Figure 4.4**). Holes on the collar's outer edge are for attaching it to a flat metal mounting plate, while holes in its inner part are for attaching the sensor to the collar. The top of the collar provides a surface for a geodetic survey rod to be placed for levelling to nearby benchmarks. NOAA (2013a) provides installation instructions, while technical drawings of the collar

Examples of mounting frame are:

- (i) **Figure 4.2** shows a simple frame and arm used for several installations in Africa and the Indian Ocean. In this case the arm is in a pre-determined fixed position when bolted to the frame.



Figure 4.4 The mounting collar used by NOAA for horn radar gauges such as the Waterlog H-3611. The collar is a 1-inch thick disk of aluminium with holes for attachment of the sensor to the collar and of the collar to the supporting frame. A levelling rod can be placed on an area on the top face of the collar to enable geodetic connection to neighbouring benchmarks. (Photographs NOAA).

and associated equipment (e.g. a PVC cover used to protect the sensor) may be obtained from robert.heitsenrether@noaa.gov. In turn, the metal mounting plate has triangular brackets on each side that permit the entire mount and sensors to be attached to different structures, for example piling and bulkhead mountings as shown in [Figure 4.5](#).

- (v) Some manufacturers mount the radar gauge horizontally in a tube that projects out over the water. The gauge is located at the landward end of the tube and transmits to a 45° reflector at the other end. The radar beam is thereby reflected down to the sea and returns via the reflector to the sensor.

Radar Gauge Mounting in a Stilling Well

An alternative form of mounting is to use a horn antenna radar gauge installed at the top of a stilling well, instead of over the open water. This option may be a particularly desirable one where there is a long-established stilling well; otherwise the cost and difficulty of constructing a new well may be a disadvantage. The stilling well ensures that the measured sea surface is as calm as possible

to ensure optimal reflection. The essential point is for the well diameter to be large enough that reflection of most energy takes place from the water surface at all states of the tide (especially low tide) and not from the metal walls. Reflections are also sensitive to metal pieces inside, and even outside, the well that create false echoes. In practice, the option of using a radar in a conventional well will work best where the tidal range is small and the well is not too long. The stilling well should be regularly cleaned to maintain accuracy (unlike open air installations which are relatively maintenance free). Horn antenna gauges mounted in existing stilling wells in France are described by André et al. (Supplement). In cases with strong multipath signals in an existing well, it may be best to use instead either a stainless steel tube or a GWR sensor, both described below.

Another approach that involves stilling of the water has a radar gauge, without its horn antenna, mounted at the top of a vertical stainless steel tube (approximate diameter 8 cm), that has a conical end for noise filtering, as for a conventional well with a float gauge, and that also functions as a waveguide for the radar. The waveguide provides a better propagation with limited

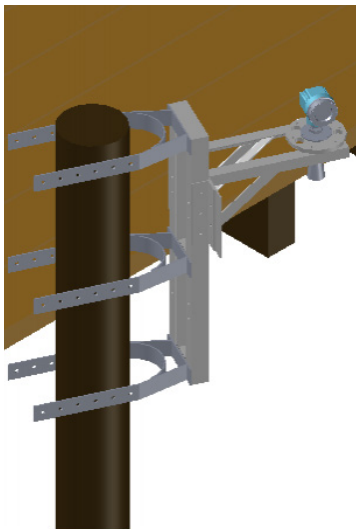

PILING CONCEPT WITH CONJUGATE RAILING BRACKET AND REDESIGNED PILE CLAMPS

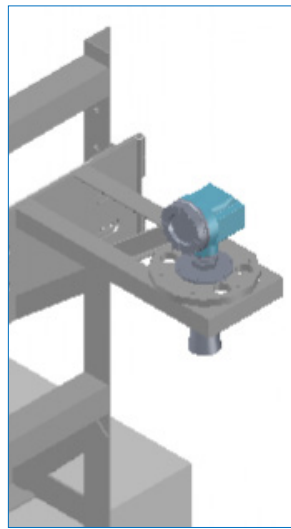

BULKHEAD INSTALL WITH MWWL BULK-HEAD MOUNT

Figure 4.5 The NOAA flat metal mounting plate with triangular brackets on each side that enable convenient attachment to different types of structure (e.g. piling and bulkhead mountings in this case).

loss of power and also cuts down on false echoes. André et al. (Supplement) provide an example of this technique at Fos-sur-Mer, France where a second tube is used for calibrating the radar by means of dipping measurements. **Figure 4.6** shows another installation in Dragør, Denmark, in this case with a 17 cm diameter tube. The tube has to be seamless so as not provide false reflections, and has to be kept as clean as possible. A further aspect concerns whether the sea (and the water in the tube) freezes in winter, in which case a back-up pressure sensor is needed.

Guided-Wave Radar Mounting

Another option for a stilling well mounting is provided by a Guided-Wave Radar (GWR) gauge (**Figure 4.7a**). The main lobe of a radar pulse propagates down a special stainless steel wave guide cable dipped into the water and reflects where the dielectric permittivity of the surrounding medium changes (i.e. the air/water interface). Most of the radar energy propagates close

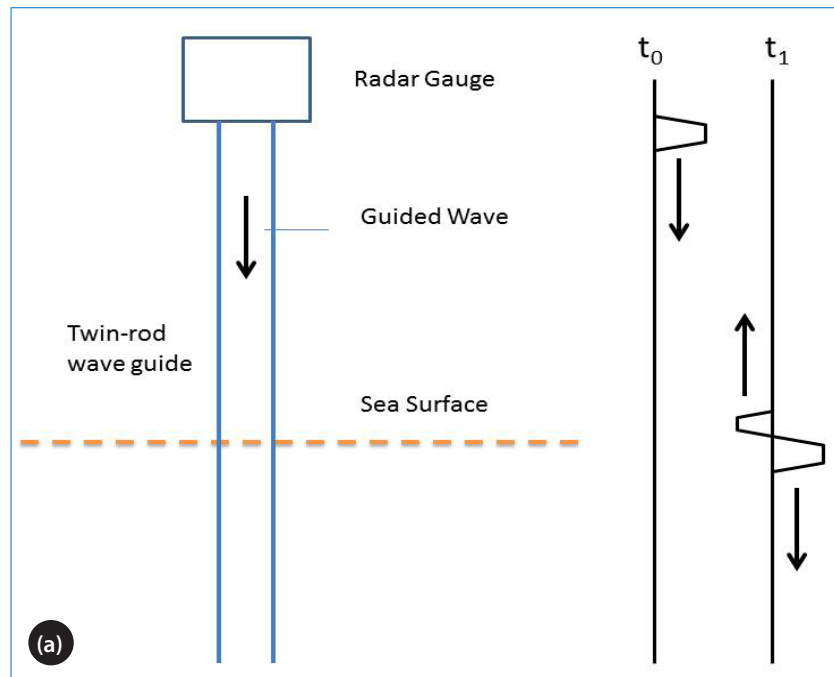

Figure 4.6 An installation at Dragør, Denmark. On the left can be seen an Endress+Hauser radar gauge mounted on top of a stainless steel tube (approximately 17 cm diameter) that functions as a stilling well and waveguide. This tube has an end cap with a 30 mm diameter inlet. Inside the tube is a filter to prevent biological intrusions. At the top of the tube are 4 holes with filters to prevent condensation on the radar antenna. On the right is a stainless steel tube containing pressure sensor cables. (Photograph Danish Meteorological Institute).

to the waveguide (typically 80% within an 8 inch radius according to Riley and Jethra, 2012) and so more energy is reflected back to the transmitter than with open-air radar. The functions of the well in this case are to still the water and provide protection to the cable.

This technique is also called Conducted Wave or Time Domain Reflectometry and was developed for the measurement of levels in industrial tanks. Most experience with these instruments as tide gauges has been obtained in France using the Krohne BM100 sensor. Martín Míguez et al. (2008a) described its operation in a large (1 sq.m) stilling well at Brest where several millimetric agreement was obtained between water level in the well measured by the radar and

by a manual probe over many tidal cycles (this is known as a Van de Casteele test, see Volume 1 of this Manual), while the agreement was centimetric in a similar-size well at Roscoff. Coarser agreement in the latter was considered to be partly due to less accurate manual probe measurements.



(b) A GWR sensor installed in an existing stilling well at Sète, France. (Photograph SHOM).

- (c) The steel wave guide cable (4 mm diameter) used at French GWR installations with a cylindrical weight (20 x 100 mm) to hold the cable vertical. At many locations, the weight may need cleaning occasionally to remove biofouling.



Figure 4.7

- (a) Schematic of a Guided-Wave Radar (GWR), or Time Domain Reflectometry, in a stilling well with some of the transmitted energy reflected at the sea surface, adapted from Brumbi and Van Zyl (2009). A twin-rod wave guide is shown in this example. The overall travel time of the guided wave will be $2(t_1 - t_0)$, and the height of the radar gauge above the sea surface will be $c(t_1 - t_0)$ where c is the speed of light.

The older generation BM100 sensor has now been largely replaced by the Optiflex 1300C which has improved radar characteristics and higher accuracy, and lower power requirements. SHOM operates them in stilling wells with diameters of at least 300 mm, in types of wells varying from old stone constructions to polyethylene tubes (Figure 4.7b, see also <http://refmar.shom.fr> and André et al., Supplement). Single or double cable or rod waveguide systems are available. Long rods can be unwieldy for use in stilling wells, and a cable waveguide with a weight at its end to keep it taught and vertical is preferable (Figure 4.7c).

Similar types of waveguided radar gauge are made by other manufacturers (e.g. VEGAFLEX-81 or Endress+Hauser Levelflex). The VEGAFLEX-81 documentation explains how the GWR must be installed in a metal (not plastic) tube, with a centering weight to keep the cable vertical.

4.4 Before Installation

Determination of the Sensor Offset

One of the most important issues for any tide gauge, radar or otherwise, is to know the datum of the sea level measurements that it provides. For a radar gauge that transmits vertically downwards, we have to know the point within it which corresponds to zero measured range (that we denote the Point of Zero Range, PZR), and the relationship between the PZR and a clearly defined Reference Survey Mark (RSM) located on, or readily relatable to a point on, the gauge casing. The height difference between RSM and PZR is called the Sensor Offset (SO):

$$SO = RSM - PZR$$

with SO having a positive value when the RSM is above the PZR.

The sea level recorded by a radar gauge will be calculated from the recorded range using an offset (e.g. 10 metres) in the data logger such that:

$$\text{Recorded Sea Level} = \text{Logger Offset (LO)} - \text{Recorded Range}$$

The datum of the recorded sea levels (Logger Datum) will be at a level LO below the RSM only if the PZR and RSM coincide (Figure 4.8).

Most radar gauges will have been purchased with an unspecified SO, and one must not assume that the PZR is 'obviously' at the top of a horn antenna or the face of a planar antenna. Other gauges will be claimed by their manufacturers to have a PZR at a particular point on their casing, but this claim must not be relied upon. For example, the OTT RLS sensor has a specified offset of -7 ± 6 mm from its Teflon ground plate (Illigner et al., 2016). However, similar sensors from the same manufacturer cannot be assumed to have the same PZR; for example, Heitsenrether et al. (2012) concluded that those of different Waterlog H-3611 sensors varied by approximately ± 1.5 cm.

This issue is recognised in the information sheets of many gauges sold to the hydrological community, whereby a user is required to determine the SO by comparison of measured radar water levels to those observed on a nearby river board (the zero of which could be known in terms of a local datum). This procedure is called 'Setting the Stage' (WMO, 2010). In hydrological applications this method is acceptable because rivers, lakes and reservoirs tend to have smaller waves than the ocean, and the accuracy of this visual stage-setting should be better than 1 cm, which will be acceptable for their purposes.

In principle, the SO of a radar tide gauge could be estimated in a similar way after it had been installed, by comparison of measured radar levels to those observed on a tide board. However, the method is likely to be less accurate in the sea than in rivers, especially when large waves are present, and less accurate than the methods described below. Nevertheless, this common-sense approach can provide a useful check on the gauge datum during maintenance visits; we return to this option below.

The SO of a particular sensor can be determined in the laboratory before installation by performing a set of radar range measurements to targets, with the real range measured by tape. A first task is to define the RSM reference mark on the casing from which tape measurements can be made to the target. Most gauges do not have a clearly-indicated mark but that problem is easily solved: if there is no obvious mark on the casing that can be used, then one can be simply scratched or painted on it. However, it should be chosen sensibly so that, when the gauge is installed in its mounting, the mark is accessible for readily relating to other marks on the mounting and thereby to local benchmarks using levelling (Chapter 6).

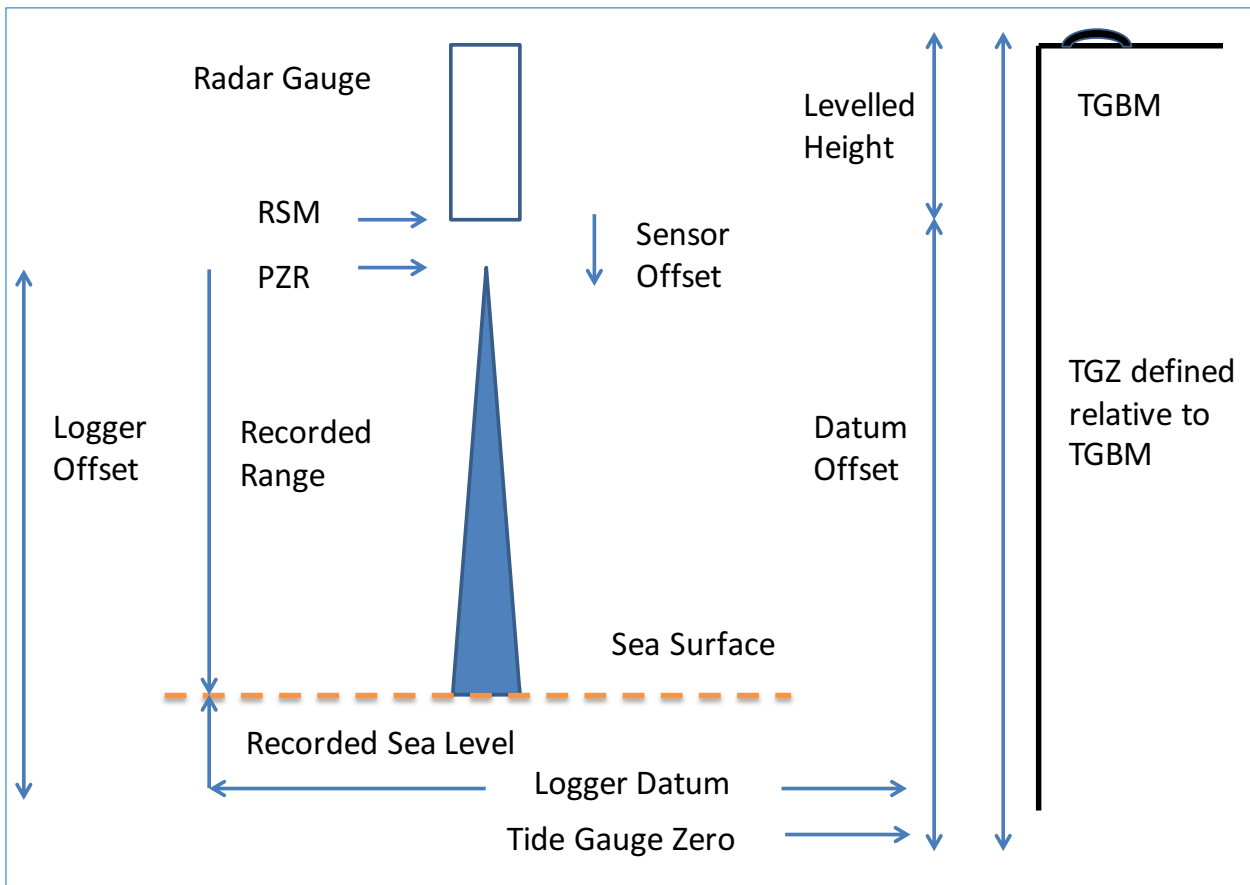

Figure 4.8 Schematic of a radar gauge, the Reference Survey Mark (RSM) on its casing, its Point of Zero Range (PZR), Logger Datum, Tide Gauge Zero (TGZ), and the Tide Gauge Benchmark (TGBM). All of these levels must be known relative to each other.

Suitable targets are flat metal plates and water pools, and the size of the target should be at least twice what one would estimate knowing the approximate range and the radar beam angle full-width. An example of a target for a short range measurement is shown in [Figure 4.9](#). For longer ranges, the gauge can be mounted on a laboratory frame so as to reflect off the metal or water targets on the floor, with the height of gauge above the target adjustable from approximately 1 to several metres, and the real ranges measured by tape each time. If longer ranges are required, then the gauge could be mounted to transmit horizontally to a more distant (and larger) metal plate target across the laboratory.

Differences between radar and tape measurements should be investigated for all ranges. If the observed SO changes with range, then the scale error could be due to incorrect 4-20 mA current loop scaling factors in sensors that do not have digital readout. Anomalies could occur at short range where some gauges have a measurement 'dead zone'. Anomalies could also occur when the beam reflects off nearby laboratory walls or equipment. Therefore, any strange results should

be verified by moving the gauge and target to ensure that clean reflections are taking place. Examples of SO determination using targets in this way have been presented by Heitsenrether and Davis (2011) and Pugh et al. (Supplement).

By these means, the SO will be determined and the measurement of range can be confirmed to be precise (apart from the SO) from short to long ranges. All appropriate information for each sensor must be carefully noted, including sensor model number, serial number, date and operator name. If possible, environmental information (especially temperature) should also be recorded. In addition to these essential tests involving SO and range linearity, NOAA undertakes time response tests in which the radar responses to rapid movements of a target are compared to laser measurements, thereby determining whether each particular sensor has a similar response. These tests are primarily relevant for ensuring that the sensors are correctly set up for fast response time mode (i.e. 1 second or similar), as discussed in the following section.



Figure 4.9 An example of a laboratory target used to determine a Sensor Offset (SO) using a range measurement of approximately one metre. The circular flange of the sensor is set flush against the outside surface of the mount, and the distance to the inside surface at the other end of the mount is measured accurately by tape. The distance recorded by the radar is then compared to the tape-measured value giving $SO = \text{Tape Range} - \text{Radar Range}$. (Photograph R. Heisenrether, NOAA).

The SO information must be included in the metadata for each real-time data set that is passed to data centres for subsequent delayed-mode processing (Chapter 8).

Other Things Before Installation

Some radar gauges can be operated in different modes that provide different choices of sampling rate or damping (which relates to sensitivity and noise). The different modes should be described in the manufacturer's documentation although sometimes the information is not as complete as it should be. Therefore, each mode option needs to be investigated as thoroughly as possible by discussion with other experienced users and the manufacturers. Occasionally, the default 'out of the box' mode will not be the most appropriate for sea level measurements. Ultimately, the only way to be satisfied that an acceptable mode option has been selected, and good data are being delivered, is by comparison of the radar data with the sea level information obtained by other technologies.

As an example of sampling, the Waterlog H-3611 pulse radar gauge can be operated in Normal (or Standard) or Fast modes that can provide single measurements at typically 1 Hz that can subsequently be filtered in off-line processing of the data to remove wave effects (Boon, 2013; 2014). Fast mode is faster as it does not perform the higher level of internal filtering that Normal mode applies. However, Fast mode is too fast for some data loggers so may not be an appropriate option.

There is also a special "NOAA mode" which involves 181 measurements one-second apart every 6 minutes, giving 10 averages and standard deviations each hour as for the acoustic gauges previously used by NOAA.

An example of choice of damping of the output signal is provided by VEGAPULS gauges which are known to take many 10s of seconds to respond to rapid changes (Heitsenrether and Davis, 2011). Damping has been shown to effectively smooth out the high-frequency influence of waves at some sites (see paper by Pugh et al., Supplement).

Choice of Radar Sampling

If radar gauges are to deliver the reliable 1- (or 3- etc.) minute average values of sea level that are now required for GLOSS and tsunami monitoring (Chapter 5), then it is now clear that they have to sample at a much higher rate so as to average over the variability in level due to waves. In this case, the 1 Hz sampling provided by some of the sensors in Appendix 1 would be ideal (e.g. Pérez et al., 2014).

However, some national groups have not had, and do not still have, a requirement for such high rate measurements because their focus remains on changes in sea level due to tides, surges and mean sea level, rather than tsunamis and other rapid events. For their purposes averages over typically 6 or 15 minutes are adequate. (Indeed, the first implementation plans for GLOSS specified a requirement

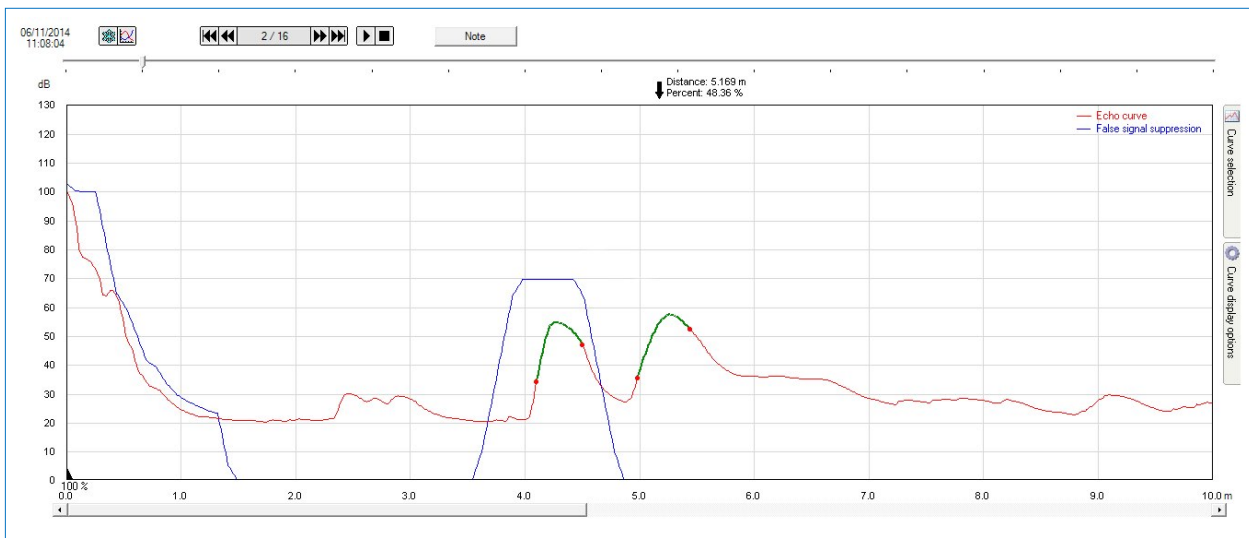

Figure 4.10 An example of an echo response curve, shown in red, from a VEGAPULS-61 installation at Bournemouth on the south coast of England. The plot shows the energy received back at the sensor as a function of distance beneath it (or time). In this case, the main peak of energy, shown in green, is from the sea surface which is 5.169 m below the gauge. However, there is also a second peak, shown again in green, from an exposed walkway approximately 1 m above the water level. The gauge can be programmed to normally reject echoes from such sections of the response curve within the blue lines, unless the main peak itself migrates into the blue area.

for only hourly values.) This partly explains why some groups use a coarse sampling of once per minute for a radar gauge and then average those into 15-minute values (e.g. Pugh et al., Supplement). Other groups have different strategies (e.g. SHOM averages 15 consecutive 1-second values into a '1-minute' value), with the importance attached to 'temporal filtering' depending on whether 'mechanical filtering' is also employed.

We believe that all groups should now work towards a common sampling strategy, as far as is possible given the different radar equipment in use. In addition, we suggest that the best strategy is to record at 1 Hz or higher frequency (e.g. 2 Hz is used by groups in Spain and 4 Hz in Chile) and average to 1-minute values. Furthermore, it is important that the sensor be set up for a fast time response mode to take advantage of the high rate sampling. In many cases, the radar sensors and/or their loggers will not be capable of providing this high rate. (For example, the OTT Kalesto sensors, no longer manufactured but still in use in many countries, provide one minute values by making 40 measurements in a 17 second window. They have been replaced by the OTT RLS which samples at 16 Hz and averages over 20 seconds.) Nevertheless, in these cases our recommendation is that they be set up to sample as fast as they can (e.g. once every 3 seconds) from which 1-minute values can be derived from as large a sample of individual measurements as possible. Of course, the feasibility of measuring rapidly, given the available sensors and loggers, must be tested in the

laboratory before installation. At locations where waves introduce significant bias into the radar measurements, then simply measuring at a higher rate will not necessarily solve the problems; only extensive comparisons to data obtained by other methods will show whether the radar data are adequate for scientific purposes.

4.5 During Installation

Radar Installation Software

Several manufacturers provide communication hardware and PACT (Process Automation Configuration Tool) software in order to set system parameters and display the echo response curves from an installed sensor. These curves show the amount of energy received back at the gauge as a function of distance from it. If unwanted reflections, perhaps from a support frame, are stronger than those from the sea surface, then false sea level measurements could be recorded. The software allows parameters to be set so as to blank off strong reflections within a certain range of distances. However, if the software demonstrates significant unwanted reflections, then it may be advisable to re-site the gauge. **Figure 4.10** provides an example of a response curve from a VEGA sensor on the south coast of England. NOAA (2013a) provides examples for Waterlog sensors.

Datum Determination

An essential component of an installation is the determination and documentation of the relationships between the various levels involved. The Sensor Offset will be known from either previous laboratory measurements, as described above, or can be verified (less accurately) using the methods after installation described below.

The main measurement required by levelling is that of the height of the RSM relative to that of the TGBM (or set of local marks, see Chapter 6). This measurement allows sea levels to be expressed relative to the usual datums employed in tide gauge measurements. In **Figure 4.8**, we have represented this datum as the Tide Gauge Zero (TGZ), although it could as well be Chart Datum or Station Datum. In any case, the TGZ or other datum will be defined relative to the TGBM. (These datums are sometimes subject to redefinition and it is essential that all changes are fully documented.)

The height of the RSM above the TGZ will now be known from the levelling and is called the Datum Offset (DO). From knowledge of SO and DO, we can express sea level relative to the TGZ by:

Sea level above TGZ = Recorded Sea Level + PZR height above TGZ – LO

= Recorded Sea Level + (DO – SO) – LO

= (DO – SO) – Recorded Range

Van de Castelee Test

André et al. (Supplement) point to the usefulness of a Van de Castelee test as a check on radar timing and scale errors, using another gauge (even a tide pole) as a reference. Such a simple test could be repeated easily during regular maintenance visits. This test requires measurements through complete tidal cycles (Martín Míguez et al., 2008b). However, if time is short then measurements around high and low water (especially at springs) would be almost as useful. This could be an important check where 4-20 mA current loops are used instead of digital outputs, where the scaling is incorrect. Van de Castelee tests have been very useful in demonstrating the temperature dependence of acoustic measurements in stilling wells, with similar errors absent in radar measurements.

4.6 After Installation

Verification of the Sensor Offset

Once the radar gauge has been installed, the SO can be confirmed using several methods (or determined if for some reason the gauge was not calibrated previously in the laboratory). For all methods, we take advantage one way or other of an understanding that, unlike some other tide gauge technologies, radar gauges have little or no long-term instrumental drift and so do not require frequent re-calibration.⁹

A first method is to perform a set of tide pole measurements to 'Set the Stage' as described above, with the zero of the pole known with respect to the TGBM (e.g. as shown in **Figure 4.11a**; another photograph at the same site in **Figure 4.11b** highlights the problem of boats passing under the beam mentioned above). Advice on how best to make tide pole measurements is given in Volume 1 of this Manual. It is difficult to say how many measurements will be needed, but more precise visual observations of the pole and a more accurate determination of the SO will be possible in calm conditions. Perhaps measurements over several days should suffice. Measurements should be made through the tidal cycle, but at locations with a large tide one should focus on measurements at the turning points when the tidal level is not changing rapidly. Linear regression between radar and tide pole levels should yield a 45° slope (unless the radar data has a scale error), an offset which should correspond to the difference between the Logger Datum of the radar gauge and the zero of the tide pole, and an estimated standard error of the offset. If the latter is centimetric then the procedure should probably be repeated in calmer conditions. Some experiences using tide pole and dipper measurements for ongoing checks on radar offsets have been described for stations in Indonesia by Illigner et al. (2016).

⁹ In practice, radar gauges must suffer some long-term drift, as well as temperature effects, regardless of how well designed they are. All sensors will have a built-in frequency or time reference which would normally be a temperature compensated crystal oscillator (TCXO) that will be subject to some long-term ageing. In addition, the electrical properties of mechanical components such as the antenna and connecting cables, including transmission lines on printed circuit boards, will depend to some extent on temperature (Øistein Grønlie, private communication). However, such drifts can be expected to be significantly smaller than those of other types of tide gauge.



Figure 4.11

(a) A tide pole at a tide gauge installation at the Île d'Aix on the west coast of France beneath a Khrono radar gauge shown in the insert. (Photographs Laurent Testut, Littoral ENVironnement et Sociétés (LIENSs), University of La Rochelle).



(b) The same scene in the busy summer season with a boat under the radar.

A second method is conceptually the same as the exercise with the laboratory metal plate target described above. In this case, the target (that some groups call a 'stirrup') is slung beneath the gauge such that the plate is at a known distance below the reference level mark on the gauge casing (known from the design of the supporting frame and confirmed by tape measurements of the whole assembly in the laboratory before installation). Reflections off the metal target will be highly precise and a suitable set of data should be obtained in an hour. Therefore, the occasional installation of the stirrup (e.g. during annual maintenance visits) need not interfere significantly with routine measurements. **Figure 4.12** shows examples of

stirrups at Luderitz, Namibia and Simon's Town, South Africa; another example at Holyhead, North Wales is shown by Pugh et al. (Supplement). Papers by Farre and by SANHO (Supplement) provide further information on the use of stirrups and the calibration of the radar gauges.

A third method using a so-called 'dribbler gauge' is described by Pugh et al. (Supplement). This has been found to be a highly precise technique for determining the datum of a radar (or potentially any other) gauge. That paper describes how a temporary plastic drain pipe (similar to a stilling well but closed at its bottom end, with a hole at a known height with respect to the TGBM at approximately MSL) and pressure transducer can



Figure 4.12. Examples of the use of the 'stirrup' target at Luderitz, Namibia and Simon's Town, South Africa. (Photographs Ruth Farre, South African Navy Hydrographic Office).

determine the datum of the primary gauge accurately. It has an advantage over the stirrup of not interrupting the radar gauge's measurements.

There are several possible variants of this method, each of which takes its inspiration from the 'B gauge' technique for pressure gauges (Woodworth et al., 1996). For example, one could imagine using a temporary, second radar gauge reflecting off a metal plate target, installed also at a known height with respect to the TGBM at approximately MSL. The rectified tidal curve from the second radar would then allow the datum of the primary gauge to be determined.

Finally, one could suggest removing an installed gauge occasionally, for re-calibration in the laboratory, and replacement with another calibrated gauge.

4.7 Need for Other Sensors

Experience with radar gauges so far has shown that they work well at some locations, while at others they have been clearly affected by waves to a lesser or greater extent (Chapter 3). If one is to rely on radar as the primary sensor, then a method is needed to quantify the time- (i.e. wave-) dependent accuracy of the measurements. An appreciation of how radar accuracy may vary can be obtained from a comparison of data from the radar to that from a pressure sensor over an extended period (e.g. see the paper by Pugh et al. in Supplement). In a subsequent permanent installation of both types of gauge, one might even potentially combine the two sets of sea level data into one optimal record. (Such an optimal combination was made for data from the Spanish REDMAR network when older acoustic and pressure gauges were replaced by Miros radar gauges, Pérez et al., 2014).

A suggestion to install a pressure sensor may seem strange for a manual concerned with radar gauges, especially as pressure gauges lack all the advantages of radar: their installation requires a diver, or the provision of a frame to attach the sensor to that can be immersed in the water and bolted from above; they suffer from instrumental drift; and some pressure sensors have been found to corrode rapidly at certain locations, requiring regular replacement.

On the other hand, pressure sensors are relatively inexpensive, and they can provide data that is complementary to that from the radar: they can sample at high rates so as to measure waves; and they are capable of continued recording during the most extreme events when sea level could have exceeded the height of the radar gauge.

In the context of this Manual, which presupposes having a radar gauge as the primary instrument, a pressure gauge should be regarded as almost a disposable sensor that offers its own merits complementary to the stability and probable long operational life of the radar gauge. Some years ago, these considerations led to a decision to install radar plus pressure gauges at a number of sites in Africa and the Indian Ocean where considerable experience was acquired on the use of the two technologies. Corrosion occurred in some pressure sensors associated with the choice of casing material, while others worked well. For example, this type of combined installation has worked excellently at Karachi for many years. Elsewhere, Fierro and Gaete (Supplement) have operated many sites in Chile in this way, suggesting an 18-month replacement cycle for pressure sensors, with maintenance every 6 months. Pressure sensors are anyway essential at some sites, and are not merely an option; as an example, **Figure 4.6** is a summertime photograph of a location where a pressure sensor is needed in case of the sea freezing in winter.

The suggestion of both radar and pressure gauges at new and refurbished GLOSS sites, with the capability to also record tsunamis, was adopted in Volume 4 (p. 52 and 75 of IOC, 2006). That volume explained that there should be a main sensor (radar in this case) that could record typically 3-minute average values, or higher frequency values, while a differential pressure transducer (one that measures the difference between water pressure and atmospheric pressure) would record 1-minute values or at higher frequency. The pressure gauge would be

the primary tsunami sensor and provide data to fill any short gaps in the radar record. All data would be transmitted rapidly.

One might consider other techniques alongside the radar gauge, such as an affordable open-air rapid-sampling acoustic sensor. That might provide complementary data to the radar that could yield some insight into wave effects. However, it would come with demerits of its own, some of which would be common to the radar (e.g. the possibility of being over-topped in extreme events). The choice of additional sensor may well be a site-specific one. However, a reliable pressure system would appear to offer the best practical option in most cases. In any case, the radar must not be installed and operated alone, delivering data to GLOSS, without some insight into its realistic performance having been obtained from a comparison to data from other techniques, with the comparison made over as long a period as possible, and with findings fully documented.

Finally, with regard to the use of pressure sensors alongside a radar gauge, we can point to other variant setups that have been suggested, although we are not aware that all have been tested. For example, one could rely on a conventional pressure sensor as the main component of the station with a radar gauge that reflects off a target at approximately half-tide (i.e. akin to a half-tide pressure gauge discussed in earlier Volumes). That would avoid the problems that some radar gauges seem to have with waves and have all the advantages for rapid sampling by a pressure gauge.

As mentioned in previous Volumes of this Manual, we recommend that any sea level measurements be accompanied by observations of atmospheric pressure, winds and other environmental parameters that are of direct relevance to sea level data analysis (see also Chapter 5). Several groups such as SHOM are now installing web cams at sea level stations as a monitor of environmental conditions.

5. Summary of Requirements for GLOSS Sites with Radar Tide Gauges

The GLOSS Implementation Plan 2012 (IOC, 2012) called for two major upgrades to all stations in the GLOSS network: (1) for the station to report in real time to the IOC Sea Level Monitoring Facility, and (2) for continuous GNSS measurements to be undertaken as near to the tide gauge as possible. In addition, it restated the obligations of participants in the GLOSS programme. The following summary of requirements for GLOSS tide gauges, and for radar gauges in particular, should therefore be read alongside the appropriate sections in IOC (2012). This summary updates those in Appendix 1 of Volumes 3 and 4 of this Manual.

General GLOSS Requirements

- The main requirement for a tide gauge in GLOSS has always been for it to be capable of measuring instantaneous sea level with a target accuracy better than 1 cm at all times i.e. in all conditions of tide, waves, currents, weather etc. This requires dedicated attention to gauge maintenance and data quality control.
- GLOSS gauges are required to measure sea level over periods long enough to avoid aliasing from waves, e.g. averages of typically 3, 5, 6, 10 or 15 minutes have been usual until now. However, radar gauges should be capable of providing 1 minute averaged data, or higher frequency if possible, especially when the gauge is to be used for tsunami warning.
- Data timing accuracy should be compatible with the required level accuracy, which hitherto has meant a timing accuracy better than one minute. However modern data loggers should be capable of attaching times to measured levels with an accuracy of seconds with the use of GNSS.
- Measurements must be made relative to a fixed and permanent local tide gauge bench mark (TGBM). This should be connected to a number of auxiliary marks to guard against its movement or destruction. Connections between the TGBM, auxiliary marks and the gauge zero should be made to an accuracy of a few millimetres at regular intervals (e.g. annually). See Chapter 6.

- All GLOSS sites must be equipped with Continuous GNSS (usually GPS) receivers located as close to the gauge as possible. These will be used for studies of vertical land movements and satellite altimeter calibration. Local levelling ties between the GNSSBM and TGBM must be undertaken at the same regular intervals and reported to GLOSS as part of the overall data provision. See Chapter 6.

Tide Gauge Requirements

- The site should have a main sea level recording tide gauge recording at 6 or 15 minutes or similar, as described above (e.g. a radar gauge or other established technology).
- The site should also have an ancillary pressure sensor sampling at typically 1 minute or higher frequency (e.g. 15 or even 1 second if wave information is required), to provide a primary source of information in the event of a tsunami, and to enable any gaps to be filled in the main sea level record.
- One should beware when tide gauges are replaced that different types of gauge can have different systematic errors. Those errors may be irrelevant for time-series work if the same technique is always used. However, changes of technology can lead to biases between old and new data sets. New-technology gauges (whether radar or another technique) are by definition less well understood than previous ones and they must be operated alongside the older techniques for an extended period until sufficient experience has been acquired. See Chapter 3.

Radar Gauge Requirements

- A user must appreciate that, while radar gauges offer many advantages over earlier technologies, they may not be optimum in all situations. Therefore, the user must be prepared to reject the use of radar at locations where they do not work well.
- Such experience needs to be acquired at each location before data are delivered to GLOSS, with radar gauges tested alongside previous or alternative technologies

so as to assess wave and other influences on the radar measurements.

- Before deployment and at intervals during operations, the range bias of the radar gauges must be determined as described in Chapter 4.
- The requirement for 1-minute data (or 3-minutes etc.) implies that the radar gauge be set up to measure at 1 Hz or faster if possible, from which 1-minute averages can be derived. The way this sampling and averaging is made will depend on the equipment used (Section 4.4). The sensor must be set up with fast response time mode in order to take advantage of the rapid sampling.
- At some sites, where the installation of a stilling well to perform mechanical filtering is employed, then regular cleaning operations must be undertaken.
- As explained above, where radar gauges replace earlier technologies at long-term stations, there should be a period of overlap of at least a year, so as to test for seasonal effects, with the differences in sea level between techniques at various timescales (hourly, daily, monthly) fully documented.

Site Requirements

- The general site requirements, and the particular ones for radar gauges, discussed in Chapter 4, must be taken into account when alternative sites are being considered.
- The site should have mains power or storage batteries/solar panels and backup power supplies, especially when the gauge is intended for monitoring tsunamis and storm surges.
- The sea level measurements should be accompanied by observations of atmospheric pressure, and if possible winds and other environmental parameters, which are of direct relevance to sea level data analysis. If the installation of a meteorological station is not feasible at the site (e.g. because it is in a crowded port) then arrangements should be made to obtain data regularly from the nearest met station.

Telemetry and Data Logging Requirements

- In general, radar data should be transmitted by two forms of telemetry to guard against data losses if one

form of telemetry fails. The recommendations of IOC (2011) can be considered to apply here, not only for the tsunamis of primary interest to that report, but for coastal hazards in general and even for the acquisition of data for mean sea level data studies. It states that *"Redundant data transmission channels (e.g. Internet or alternative (i.e. via Inmarsat BGAN or similar), as well as via dial-in modem access) should be implemented where possible. The redundant transmission can either be connected directly to the DCP/Data logger for the primary water level sensors, or it can be a separate transmission unit connected to a second water level sensor. DCP timing should be continuously controlled via GPS or Internet, especially important for satellite transmission."*

- Chapter 7 of this Manual, and groups associated with the GLOSS programme, can be consulted for the pros and cons of different telemetry methods, especially those where timely access to data is needed. For example, SHOA (Chile) has accumulated a vast experience on radar sensor uses for tsunami monitoring, as it has been exposed to three major tsunamis in the last five years. SHOA has found that NRT sea level data received at the IOC SLSMF through the GTS show a significant delay of several minutes compared to data received at its own Direct Readout Ground Stations, which could be an important issue for emergency purposes.
- One of the telemetry methods should result in data being made available to all interested users on the Global Telecommunications System (GTS), as also recommended by IOC (2011), and in accord with the UNESCO/IOC Oceanographic Data Exchange Policy which is concerned with open and ready access to data under the Mauritius Declaration of 2005. For each sensor, observations can be transmitted readily via the GTS in real-time using the WMO CREX formats for sea level data (Chapter 7), and where difficulties occur the WMO can provide help and advice to users of the GTS.
- Operators should ensure that radar data be sent in real time by any suitable method (satellite, Internet or other telemetry) to the IOC Sea Level Monitoring Facility at VLIZ (<http://www.ioc-sealevelmonitoring.org>) which provides an efficient means for monitoring the status of sea level measurements worldwide.

- In case of there being gaps or telemetry errors in the real-time data, data should also be stored on local loggers and regularly downloaded for passing to the GLOSS DM centres.

Operational Requirements

- Real time data provide a means to keep a continual check on data quality. For example, the IOC Sea Level Station Monitoring Facility provides access to continuously-updated time series plots. Their regular (e.g. daily) inspection will identify gauge malfunctions as soon as possible and lead to overall better long-term data sets.
- Data from some gauges in polar or other remote locations will inevitably be inspected less frequently, unless satellite data transmission can be installed. Similarly, data from the relatively few gauges recording only on paper charts will be slow to reach centres for quality control; these must be considered priorities for upgrading to meet modern standards.

Part
2

Updated Sections from Previous Manuals

6. Datum Control and Levelling

6.1 Introduction

This chapter is concerned with the datum control of tide gauges. Datum control is essential for all gauges if they are to deliver the long-term sea level data for scientific research that can be included in data banks such as the PSMSL (Chapter 8). The only gauges for which the requirement for datum control does not apply are those installed solely for the specific purpose of identifying the rapid changes in level due to tsunamis, meteotsunamis or possibly storm surges. However, in practice, many ‘tsunami gauges’ are installed with the aim of providing data for ‘multi-hazard’ applications, which includes MSL change, and so they too will require datum control.

Section 6.2 presents requirements for local datum control by means of levelling from the tide gauge to a network of benchmarks on the nearby land. It is similar to sections in previous Volumes of this Manual. We summarise these requirements again here because they are fundamentally important to the operation of any tide gauge. Particular aspects regarding the local datum control of radar gauges are mentioned in Section 6.2.

Tide gauges measure *relative* sea level, where relative means with respect to the height of the land represented by the benchmarks. Geological and archaeological techniques for measuring sea level also provide relative sea level information. Consequently, any long-term sea level record will contain a contribution from vertical land movements (VLMs) that could be as large, or larger, than that of the variations in sea level due to fluctuations in ocean currents or to climate change. VLMs can result from a number of natural and anthropogenic geological processes in the solid Earth including Glacial Isostatic Adjustment (GIA), tectonics (earthquakes), soil compaction or groundwater pumping (see Pugh and Woodworth (2014) for a discussion of these topics). It is essential that the VLM at a tide gauge be monitored, irrespective of the geological processes involved at the particular site, so as to understand the relative importance of VLM to the tide gauge record.

The main method for monitoring VLMs involves the deployment of Continuous Global Navigation Satellite System (CGNSS) receivers near to the gauges. This topic is discussed in Section 6.3 and is shown schematically in **Figure 6.1**. The CGNSS measurements have application

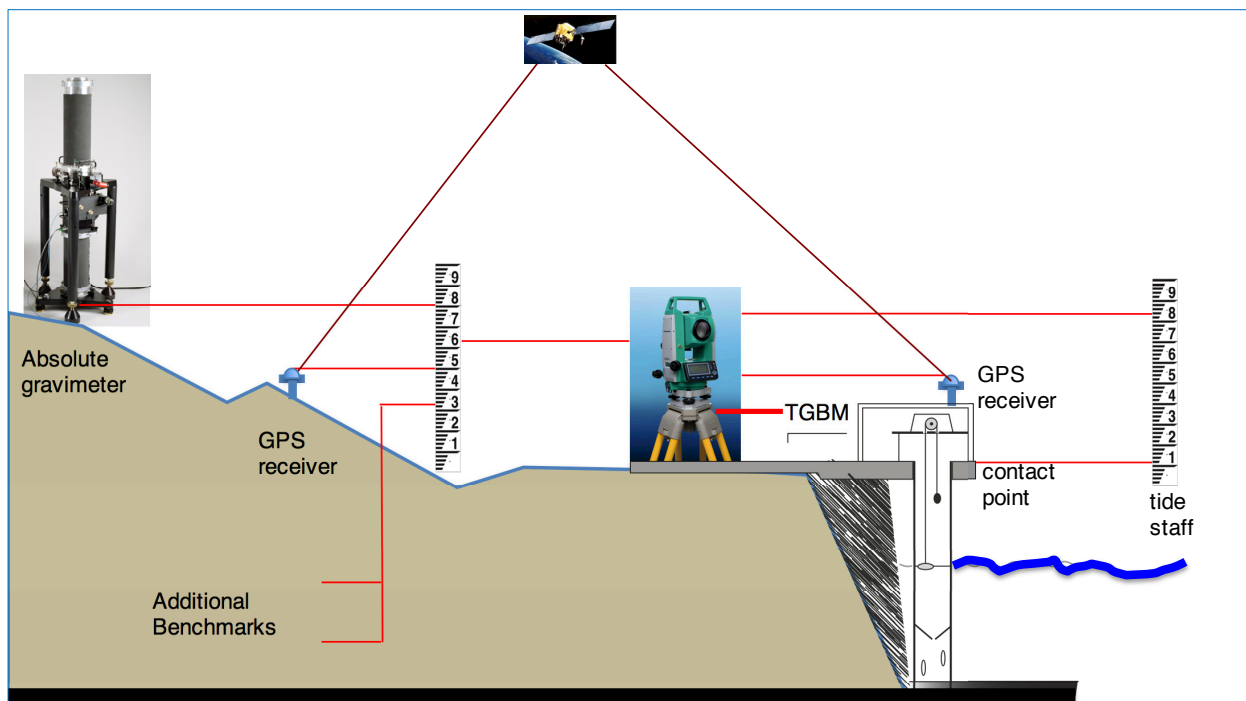

Figure 6.1 A schematic description of a tide gauge station together with a GNSS receiver for determination of the ellipsoidal height of the sea level measured by the gauge and for the monitoring of vertical land movements. Land movements are also shown being monitored in this figure with the use of an Absolute Gravity meter.

to the scientific analysis of the tide gauge data, and to the calibration of satellite altimeter information (Mitchum, 2000; Leuliette et al., 2004). In the last three decades, satellite altimetry has become the main technique for monitoring global sea level change (Chapter 9 of Pugh and Woodworth, 2014). An altimeter measurement is a **geocentric** one, with sea level measured with respect to the centre of the Earth, or to an Earth-centred standard ellipsoid. The CGNSS data can be used to convert the relative measurement of the tide gauge into a geocentric one so that both types of data can be combined in the same reference frame.¹⁰ The Implementation Plan for the GLOSS network has a requirement for every gauge in the network to be equipped with a nearby CGNSS receiver (IOC, 2012).

However, there are also GNSS requirements for gauges that are not part of GLOSS or do not have a CGNSS. It is highly desirable for a number of scientific research topics that we know the ellipsoidal heights (the heights with respect to the standard ellipsoid) of their main benchmarks and, therefore, of the tide gauge data. These requirements are discussed in Section 6.4.

Section 6.5 introduces other methods for measuring VLMs. These have been discussed at greater length elsewhere (e.g. Pugh and Woodworth, 2014) and so we summarise them simply here. Section 6.6 mentions GNSS-related techniques that are under development and may be of useful application to sea level studies in the future.

6.2 Local Benchmarks and Levelling

Benchmarks (BMs) are clearly-identified reference points that define the level of the land near to a tide gauge. BMs can be established on any stable surface, such as a quayside or harbour wall, or a substantial building. A BM on a vertical surface can take the form of a horizontal groove, or a metal frame embedded into the surface with a horizontal reference edge on which a survey staff can be rested. However, most BMs around the world take

the form of flat, domed or round-headed brass bolts that are concreted or glued into horizontal solid rock (**Figure 6.2**). GLOSS requires that there be at least five BMs within a few hundred metres, or at most 1 km, of the tide gauge. The BMs should be clearly identified in the station metadata by name or number, with a description of the mark, photographs, national grid reference and a local map. Their relative heights should be measured typically annually by means of high-precision levelling and documented in the station metadata.

The exact frequency of levelling required will depend on the local geology. On stable ground, levelling every few years may be adequate; on unstable ground, more frequent levelling may be necessary. Additional national requirements may determine other intervals. Any BMs that are shown to be unstable over an extended period need to be identified and replaced by others. If no changes are observed over long periods, it is safe to assume that the area of land around the gauge is 'stable'. The local area could, of course, be undergoing VLM with respect to a much wider area. This can be demonstrated by wide-area levelling or GNSS campaigns or from relatively new techniques such as InSAR (see below). BM heights may be expressed in a country's national levelling network, and periodically checked with respect to that network, but that is not essential for most GLOSS-related purposes (other than World Height System Unification discussed below).

The following sections define the main BMs and reference marks that are required to be levelled regularly, followed by a short guide to levelling procedures. For details on National, Chart and Working Datums and their relationships to the BMs described here, the reader is referred to Volume 4 and to sea level text books such as Pugh and Woodworth (2014).

6.2.1 Tide Gauge Benchmark (TGBM)

The tide gauge benchmark (TGBM) is the main BM chosen from the set of at least five marks, on the basis of its stability and longevity, or otherwise on its adjacency to the gauge. The TGBM serves effectively as the datum to which the values of sea level from the gauge are referred. It may sometimes be necessary to redefine the TGBM, if the original is destroyed by local development. That is where the benefit of having multiple local marks, regularly interconnected by high-precision levelling,

¹⁰ The reference frame almost always used is the International Terrestrial Reference Frame (ITRF) which is defined by four geodetic techniques: GNSS, DORIS, Satellite Laser Ranging and Very Long Baseline Interferometry. New versions of the ITRF are published every few years. For example, the version dated 2008 is described in detail by Altamimi et al. (2011). At the time of writing, the most recent version is that dated 2014 (http://itrf.ign.fr/ITRF_solutions/2014/).



Figure 6.2

- (a) A domed brass benchmark from the US National Ocean Survey (predecessor of the National Ocean Service) with a diameter of approximately 3.5 inches, one of many sometimes ornate marks used by US geodetic agencies (from Leigh, 2009).
 (b) A smaller domed brass benchmark as used by the National Oceanography Centre UK, several of which are shown in
 (c) installed in hard rock near to a tide gauge in the Falkland Islands (Photographs NOAA and NOC).

comes in by allowing the height of the new TGBM to be defined relative to the old one.

6.2.2 GNSS Benchmark (GNSSBM)

The GNSS benchmark (GNSSBM) is the BM that is located usually alongside the GNSS monument and antenna and to which GNSS data are referred. In some cases, the GNSS Antenna Reference Point (ARP) may function as the GNSSBM (although the ARP is not always accessible directly by levelling). At some locations, the GNSSBM may be 100s of metres or more from the TGBM and the gauge. Its height must also be measured regularly with respect to the other BMs by high-precision levelling. Where the distance apart is large, the height difference

could be measured by differential GNSS measurements. It is important in these cases to know whether levelling or GNSS was used for the connection, see below.

6.2.3 Gauge Contact Point (CP)

The contact point (CP) of a tide gauge is a type of BM, or vertical reference mark, associated with the gauge itself. In the case of radar gauges, it is the same as the reference mark discussed in Chapter 4 and shown in **Figures 4.4** and **4.8**. After a geodetic connection has been made between the TGBM and the CP, the gauge's sea level data can be expressed in terms of the TGBM datum (apart from consideration of the Sensor Offset for a radar gauge as discussed in Chapter 4). The essential point to note is that the CP comes with the gauge; if a different type of

gauge is installed at the site, it will have a different CP which will require re-levelling to the TGBM. See earlier Volumes of this Manual for discussion of CPs in different types of tide gauge.

6.2.4 Tide Gauge Zero (TGZ)

The tide gauge zero (TGZ) is the level for which the gauge would record zero sea level (after consideration of the Sensor Offset for the radar gauge) and which can be expressed relative to the TGBM. In practice, sea level is unlikely to fall below the TGZ if the gauge has been installed correctly.

6.2.5 Revised Local Reference (RLR) Datum

The revised local reference (RLR) datum at a gauge site is a datum defined as a simple offset from the TGBM, such that values of sea level expressed relative to the RLR datum have numerical values around 7,000 mm. The concept of the RLR datum was invented by the PSMSL so that long time-series of sea level change at a site could be constructed, even if parts of the time-series had been collected using different gauges and different, but geodetically connected, TGBMs. The approximate value of 7,000 mm was chosen so that the computers of the time (the late 1960s) would not have to store negative numbers. The RLR datum is defined for each gauge site separately and the RLR at one site cannot be related to the RLR at any other site, without additional knowledge of connections between TGBMs at the different sites. When sea level data are contributed to the PSMSL, or other sea level centre, it is essential that full information on the geodetic relationships between TGBM and other BMs and the various national datums accompany the data.

6.2.6 Levelling Procedures

Skilled personnel should perform the levelling with a good-quality digital level and barcode staff. If BMs are far apart, it will be necessary to establish 'staging points' clearly identified about 50 m apart on a hard surface. These points can be identified by painting a small ring around the point and, on softer surfaces, by driving in a round-headed pin. On rough surfaces, a 'change plate' can be used as the staging point. The levelling instrument can then be set up between a benchmark and the first staging point and readings of the staff taken



Figure 6.3

(a) A typical example of levelling at a tide gauge, in this case at St. Jean de Luz in France which had a conventional float gauge and now a Krohne Optiwave 7300C (Photograph SHOM),

at the two positions. Measurements are then made between points in the whole network, with readings taken first in one direction around the network and then repeated in the opposite direction. Modern levelling instruments with built-in data loggers can remove most of the tedious arithmetic associated with the use of a simple level, although using such a simple level is in fact very educational. **Figure 6.3(a)** shows a typical scene of levelling at a tide gauge.

As with many other aspects of tide gauge operations, the principle is that 'practice makes perfect'. The PSMSL training web pages (Chapter 9) provide a practical guide to levelling, for people unfamiliar with the technique, prepared by Prof. Charles Merry of the University of Cape Town. The aim should be to level the local network to mm accuracy. Measurements must be carefully documented and kept in the station metadata. Levelling information should also be made available to SONEL (Section 8.1.7).

The CP of a float and stilling well gauge can present a challenge for levelling as it could be located inside a confined hut, rather than in the open as for the BMs. This means that the levelling sometimes has to be undertaken in short stages in order to negotiate doorways etc. Radar



(b) An unusual type of levelling, of an Indonesian radar gauge from a boat in calm conditions (Photograph T. Schöne, GFZ).

gauges will have a CP (or reference mark) that could also be difficult to access, owing to the radar being located over the water. However, good design of the gauge mounting can make this problem easier (Section 4.3). The provision of a mounting collar, such as that used by NOAA, provides a neat solution. Similarly, if cantilevered arms are used, then it is best if the arm is designed such that, when the gauge is installed at its end, it is known what the height of the CP (reference mark) must be relative to another mark at the landward end of the arm. If the arm is likely to deform over its lifetime, then it is essential that the relationship between assumed CP and the landward mark is checked regularly.

One technique for levelling to the CP, in the calm conditions in harbours where local support is available, involves the use of a boat or floating platform, although this clearly requires more physical effort than normal levelling (Figure 6.3b). Levelling is performed with a standard level with the top of the staff held at the CP. (Alternatively, the staff could be held inverted with its zero held at the CP; when using a barcode staff, a digital level can be set to recognize that it is inverted.) Readings will take longer than in normal BM levelling and they will be less accurate. Nevertheless,

readings can be repeated several times and checked for consistency at the mm level.

6.3 CGNSS Monitoring of Benchmark Heights

CGNSS has been shown to be a mature technique for monitoring the ellipsoidal heights of BMs, such as the GNSSBM near a tide gauge discussed above (e.g. Teferle et al., 2009; Santamaría-Gómez et al., 2012; Wöppelmann and Marcos, 2016). In tide gauge work, the technique is often denoted as CGNSS@TG (previously CGPS@TG). The technique allows the MSL at the tide gauge to be defined in a global geocentric reference frame, as for satellite altimeter data, and eventually to enable the contributions to relative sea level change observed by a tide gauge to be understood in terms of sea and land level changes separately.

The development of GNSS in this way has a history spanning the past three decades.¹¹ In the early days, measurements near tide gauges were made in campaigns of a few days separated by long periods of time (called 'epochal' or 'episodic GNSS', EGNSS), often using single-frequency receivers. Eventually, the technique developed into CGNSS@TG using dual-frequency receivers, which was an essential step given that a continuous GNSS time series is much superior to an EGNSS one in allowing fuller appreciation of the spectra of signals.

An essential aspect of this work is the existence of the International GNSS Service (IGS) which coordinates the collection and processing of data from a global network of GNSS tracking stations. This data set enables the computation of significantly more accurate orbits of the satellites of the GNSS constellation than those routinely available and, thereby, the determination of significantly more accurate coordinates of GNSSBMs. For sea level studies, the GNSS data obtained from receivers in the IGS network and at tide gauges are reprocessed by the IGS TIGA working group (see below) to provide the most accurate time series of VLM for our purposes. Results are distributed through SONEL (Système d'Observation du Niveau des Eaux Littorales) which is the appointed GNSS data archive and analysis centre for GLOSS (see Chapter 8, also IOC, 2012).

¹¹ See the references listed in http://www.psmsl.org/train_and_info/geo_signals/gps.php.

As mentioned above, there is a requirement for all tide gauges in GLOSS to be equipped with CGNSS receivers (IOC, 2012). However, as the cost of receivers falls, it becomes practical that even more gauges can be so equipped. For sea level studies, it is recommended that CGNSS equipment be installed directly at the tide gauge so that it monitors any movement of the gauge directly. If the antenna is placed adjacent to the TGBM, then the GNSSBM and the TGBM will coincide, eliminating the need for levelling between the two (although the height difference between the ARP and TGBM may need to be measured). The TGBM is then the fundamental point that is geocentrically located by the GNSS measurements and to which all the sea level measurements are related. In practice, tide gauge sites in busy ports are not always ideal for making GNSS measurements. This may be due to obscured sky visibility, excessive multipath reception or because of radio interference, in which case a site

should be chosen that does not have these problems and yet is as close to the tide gauge as possible. In some locations, a second CGNSS receiver can be installed a few kilometres inland, enabling comparison between the inland and harbour VLMs. At some sites, if the CGNSS receiver is operated at high sampling rate and connected to high-bandwidth telemetry, the time series of vertical crustal movement can contribute seismic information to regional warning centres for determination of earthquake magnitudes and calculation of near-real time tsunami alerts.

Monumentation

A GNSS antenna should be mounted as close as possible to the tide gauge, or even fixed to it if the installation allows (Figure 6.4). Antennas are sometimes located on geodetic pillars with the GNSSBM nearby, such that conventional levelling can be used to provide a regular



Figure 6.4 An acoustic tide gauge at Burnie in northern Tasmania, Australia, and, to its right, a special pillar with a GNSS antenna on top. Photograph courtesy of Geoscience Australia. From Pugh and Woodworth (2014).

geodetic connection with the TGBM. At other sites, the antennas are, less ideally, installed on the roofs of buildings near to the gauges. The antenna is connected by a cable to the receiver, which may be operated using either mains, or alternate sources of, power. Advice on the operation of GNSS equipment at tide gauges is readily available including requirements for antenna monumentation (the type of pillar) and the methods of transmission of the receiver's data to a centre for analysis (Bevis et al., 2002; IOC, 2006).¹²

The Importance of Ties

If a CGNSS station is installed at some distance from the tide gauge, and if geodetic connections between them are not made, then their separate time series can still be combined usefully within studies such as sea level change and VLM in the area, or satellite altimeter calibration, if there is a working assumption that the rates of change of VLM at the two locations are the same. For these studies, it is the *rate* of VLM that is the important quantity, rather than the average ellipsoidal height difference between the GNSSBM and the TGBM.

However, geodetic connections are important for two reasons. First, the rates of VLM may not be the same at the two sites and any difference needs to be known and monitored. Second, the difference in ellipsoidal height between the GNSSBM and TGBM needs to be known for geodetic studies such as World Height System Unification (WHSU), discussed below. It is essential to document whether the geodetic connection is made using either levelling or a differential GNSS measurement.

The IGS Tide GAuge Benchmark Monitoring Project (TIGA)

In 2001, the IGS set up a pilot project called TIGA (Tide GAuge), which set itself the task of processing and analysing CGNSS data from tide gauges around the world in a consistent global reference frame (see <http://adsc.gfz-potsdam.de/tiga/> for more details). The main objective was to learn more about the practical problems of using CGNSS in the coastal environment. Since 2010, TIGA has been converted from a Pilot Project to a Working Group in recognition of its long-term importance. TIGA Analysis Centres reprocess GNSS data from long-term archives with the most recent software and methods to provide

homogeneous and consistent geocentric coordinates and time series of vertical motion. In particular, TIGA works closely with SONEL to archive CGNSS data and produce analysis products. The SONEL web site is linked to that of the PSMSL to allow combined analysis of sea and land level change information (Chapter 8).

6.4 EGNSS Surveys of Benchmark Heights

There is an important application of GNSS, even for gauges that do not have CGNSS, in measuring the height and position of the TGBM in one or more EGNSS campaigns. This information is needed first so that we know exactly where the TGBM, and the gauge, is and the coordinates so produced can be combined with maps in the station metadata (Chapter 8). It may be a surprise to some readers that even today we do not have precise details of the locations of some gauges for which there is an historical tide gauge data set.

Another reason for this information is to enable the MSL data from these stations to be used, along with data from gauges equipped with CGNSS, within geodetic studies such as WHSU that are investigating the feasibility of adopting new models of the geoid as a global datum (Woodworth et al., 2012). For these studies, we need to have MSL data expressed as ellipsoidal heights, as well as relative to the TGBM, which implies an EGNSS campaign at a GNSSBM and an accurate geodetic tie between the GNSSBM and TGBM. It transpires that the method used for the tie determines whether the important quantity in WHSU is the ellipsoidal height of the geoid at the GNSSBM or the TGBM. Consequently, if the two points are some distance apart, and if the two geoid values are significantly different, then it is essential to know which method was used to make the tie.

The data obtained in short EGNSS campaigns can be processed in two ways. The first way is to send the GNSS data to SONEL, who will process the data by modern methods and return the horizontal and vertical coordinates to the data supplier. The second way is for the supplier to process the data using web-based tools, such as the Canadian Spatial Reference System Precise Point Positioning utility from National Resources Canada (NRC, 2015). These tools are freely available and can provide any agency with high-performance GNSS positioning within a state-of-the-art processing strategy. Consequently, if the agency prefers, the data can be processed locally, and

¹² See also <https://igsceb.jpl.nasa.gov/network/guidelines/guidelines.html> for site guidelines at 'TIGA sites' and NOAA (2015) for advice to US groups. Advice on an individual basis can also be obtained from SONEL or members of the TIGA working group.

the coordinates passed to SONEL, instead of providing SONEL with the data itself. Typically, data from an EGNSS campaign of several days' duration can be processed in less than a day, with a resulting precision of ellipsoidal heights better than 5 cm, which is adequate for the WHSU and similar studies in progress. We have tested that the heights computed using these web tools differ by only 2-3 cm from those obtained using the latest solutions from SONEL (Santamaría-Gómez et al., 2012).

6.5 Other Methods for Measuring VLMs

There are other methods for measuring VLM which are described in text books such as Pugh and Woodworth (2014). The first two mentioned below were described in Volume 4, while the third has been developed into an important technique during the last decade.

Doppler Orbitography and Radiopositioning Integrated by Satellite (DORIS)

DORIS was designed by the French Space Agency as a system for determining precisely the orbits of satellites, including those with radar altimeters. It has a heritage in the earlier Doppler systems used for satellite tracking. It consists of a network of ground beacons with near-global coverage, each dual-frequency beacon transmitting signals at known frequencies (2036.25 and 401.25 MHz) to an antenna, radio receiver and ultra-stable oscillator on board the satellite. Owing to the Doppler effect, the signals received are shifted in frequency, and analysis of these shifts enables the satellite's orbit to be determined precisely. Analysis products are the time-mean station coordinates of each beacon, together with a time series of the three-dimensional motion of each beacon which may be studied alongside corresponding time series provided by GNSS. Although DORIS data have been applied to sea level studies (e.g. Ray et al., 2010), the facts that there are few beacons near to tide gauges, and that there are limitations on the number of beacons in the global network, mean that DORIS has never been as suitable to VLM determination at tide gauges as GNSS.

Absolute Gravity (AG)

An absolute gravimeter measures the acceleration of a corner-cube reflector in free fall in a vacuum using an iodine-stabilised laser interferometer with an accuracy of typically 1-2 μgal (or $1-2 \times 10^{-9}$ of the acceleration due to gravity, 'g'). This corresponds to height accuracy of 5-10 mm based on a formula dependent on upper mantle density. Campaigns of several days are usually undertaken at a location near to each tide gauge. It is usually not desirable to operate the instrument at the coast itself due to microseisms (a background noise of small seismic signals caused by waves in the nearby ocean). Older buildings (churches, schools etc.) are preferred that have dry basements and that are unlikely to be modified significantly in the future. Monumentation is important, with the instrument required to be installed on solid bedrock for which the VLM is representative of the surrounding area.

An important aspect of AG is that it is a totally different technology compared to space geodetic techniques, without the scale uncertainties involved in the construction of the ITRF. However, several factors limit the use of AG compared to GNSS. One is the high cost of the gravimeters. A second is that data can be obtained only for short campaigns, and not continuously, due to the limited lifetime of the laser and other components. A third is that the gravity measured may not be due entirely to VLM but to changes in groundwater or to surrounding buildings etc. Therefore, although AG has been applied to sea level studies (e.g. Teferle et al., 2009; Mazzotti et al., 2011), it has not proved as suitable as GNSS for worldwide applications.

New AG meters are currently being developed that make use of the free fall of laser-cooled atoms, rather than corner-cube reflectors, and which can be operated at a site almost continuously (see <http://muquans.com>). However, these are also expensive instruments that will be valuable in research but are not candidates for many deployments across a global network.

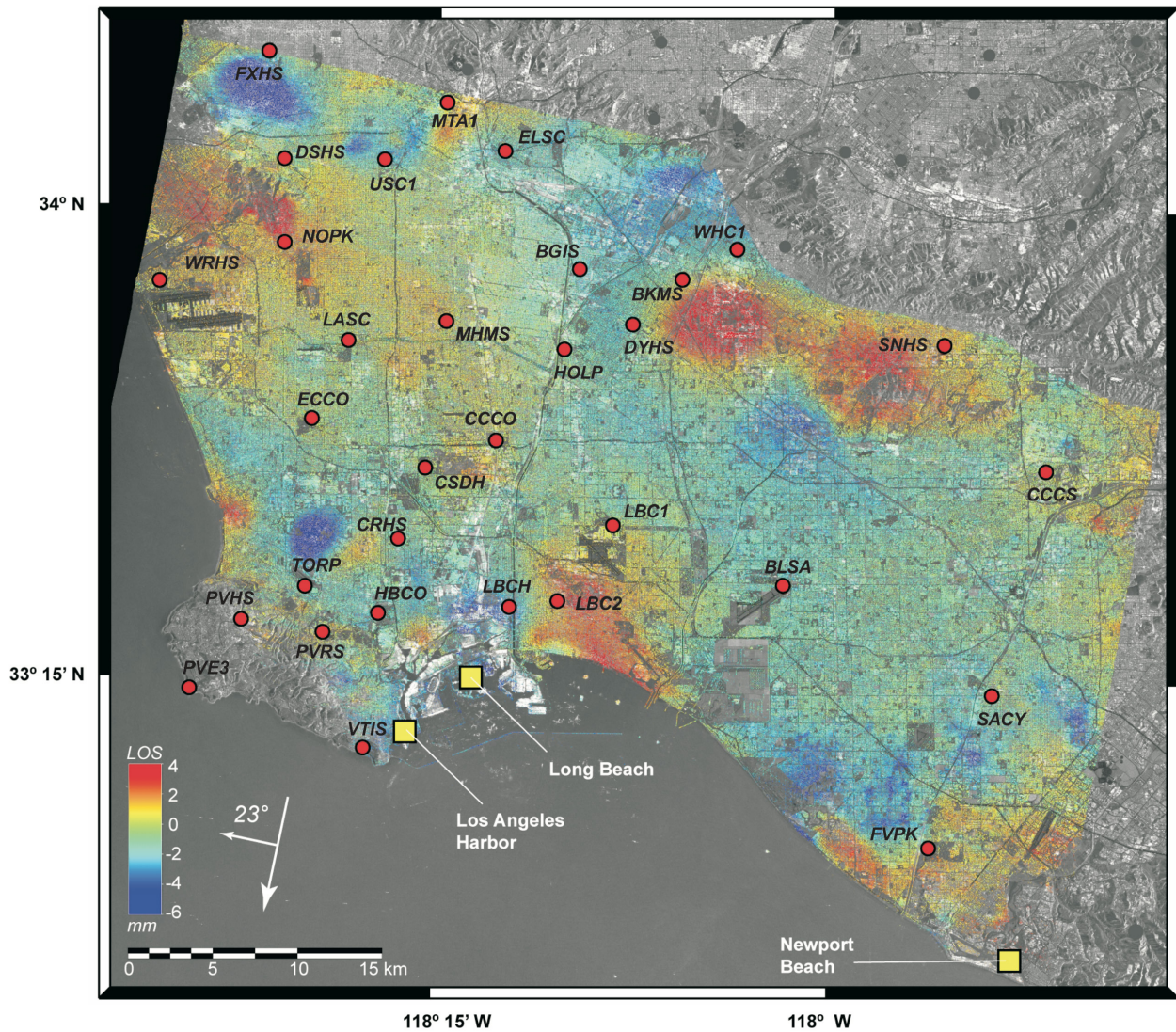

Figure 6.5 Linear line-of-sight (LoS) velocity, which for present purposes can be regarded as the rate of vertical land movement, for the period 1992–2000 using ERS-1 descending passes across the Los Angeles basin. Continuous GNSS stations used in the analysis (red circles) and tide gauge stations (yellow squares) are shown. The legend arrow shows ERS LoS azimuth and inclination (23°). From Brooks et al. (2007).

Synthetic Aperture Radar Interferometry (InSAR)

Earlier in this chapter, we stressed the importance of a local benchmark network with five or more BMs, including the GNSSBM and TGBM, that could be used to verify the stability of the surrounding area by means of repeated levelling campaigns. Many gauges are installed at coastal locations where the rate of VLM could vary significantly over a short distance. Some are located in ports constructed on reclaimed land or are near to cities where groundwater pumping is taking place. Consequently, monitoring the small number of BMs may not give a good overview of the spatial variability of VLM in the area. In particular, if the CGNSS equipment is some distance from the gauge then it could, in theory, measure a different vertical rate than at the gauge itself. One way

to monitor this possibility is to use InSAR from space (Hanssen, 2001). Satellites with suitable equipment have included ERS-1 and -2, TerraSAR-X, ALOS PALSAR and now Sentinel-1.

InSAR employs the phase-differences between repeated SAR images of an area and reconstructs the displacements in the Earth's surface as measured along the radar's line-of-sight (LoS) which is $\sim 23^\circ$ from vertical for the ERS-1 and -2 satellites. As an example, **Figure 6.5** shows findings for the Los Angeles basin demonstrating considerable spatial variability (+3.4 to -4.3 mm/yr during 1992–2000), a large part of which is due to groundwater and oil extraction (Brooks et al., 2007). As a consequence, it is almost certain that the long-term sea level trend estimated from the Los Angeles tide gauge (0.8 mm/yr) has been affected by such local land motions.

6.6 Other Sea Level Applications of GNSS

Several applications of GNSS to sea level measurement may be mentioned that may become even more important in the future:

- GNSS on buoys for satellite altimeter calibration and for tide gauge datum determination (see Section 8 of Volume 4; Testut et al., 2010; Chapter 2 of Pugh and Woodworth, 2014).
- GNSS Reflectometry using reflections of GNSS signals from the sea surface to receivers on low-Earth-orbiting satellites. This technique provides a means for remotely sensing the Earth's atmosphere and oceans with dense spatial and temporal coverage (see Section 8 of Volume 4).
- GNSS Reflectometry employing the multi-path signals that occur in GNSS measurements and that are conventionally regarded as a noise. The multi-path signals can be exploited so that a conventional GNSS receiver can be used in effect as a tide gauge as well as a monitor of VLM (e.g. Larson et al., 2013; Santamaría-Gómez et al., 2015; Santamaría-Gómez and Watson, 2016).
- GNSS Seismology wherein high-frequency measurements of station positions are employed as seismometers for rapid determination of earthquake parameters (e.g. Blewitt et al., 2006).
- Geodetic techniques that result in the much sought-after long-term stability of the ITRF with the accuracy required for applications such as sea level monitoring (see examples in Wöppelmann and Marcos, 2016).

7. Equipment needed for Telemetry of Data from Radar and Other Tide Gauges

7.1 Introduction

Timely access to sea level data can be as important a consideration as the accuracy of a tide gauge, with the relative importance linked directly to the intended applications of the data. Information from a tide gauge may be required in 'real time' (RT), 'near real time' (NRT) or in 'delayed mode', depending on the application. For example, a storm surge or tsunami warning system may require the data to be transmitted to the competent authorities in a very short time. On the other hand, for some scientific research, it is sometimes only necessary to recover the data annually, in which case it can be stored locally and recovered during a site visit, either by downloading the data to a computer or by extracting and replacing a memory card. (It is anyway expedient to adopt such a local procedure during site visits as a backup, even if a real-time communication link is in operation, to prevent loss of valuable data.)

Methods of communication depend largely on the distances over which the data have to be transmitted. For short links (e.g. harbour operations), a radio link is often convenient. For countrywide links, Subscriber Trunk Dialing on the dedicated telephone lines of the Public Switched Telephone Network (PSTN) provides an effective method. Where fixed lines are not practical, the growth in the use of mobile phones using General Switched Messaging (GSM) technology and General Packet Radio System (GPRS) protocols has extended the potential for long-distance communication. Both the fixed and mobile telephone systems give access to the Internet through an Internet Service Provider (ISP).

For more remote areas, the use of mobile satellite links is an alternative. There are now upward of 30 satellite systems in operation dedicated to data transmission, some on a global basis. Mobile Satellite Systems (MSSs) may be classified according to orbit altitude as follows:

GEO – geostationary Earth orbit, approximate altitude: 35,000 km

MEO – medium Earth orbit, approximate altitude: 20,000 km

LEO – low Earth orbit, approximate altitude: <2,000 km
LEOs can be further sub-divided into Big LEO and Little LEO categories. Big LEOs will offer voice, fax, telex, paging and data capability, whereas little LEOs will offer data capability only, either on a real-time direct readout ('bent pipe') basis, or as a store-and-forward service. Since the satellite footprint is smaller for a lower orbit, LEO and MEO systems require larger constellations than GEO satellites in order to achieve global coverage and avoid data delays. Lower power is, however, generally required for LEO and MEO satellite communications because of the shorter distance between transmitter and satellite.

Some satellites use high-gain antennas to generate 'spot beams' and so reduce the requirement of the mobile device on the ground to have a complex antenna and/or high output power. Nowadays, MSSs are totally flexible, supporting the latest IP services, as well as traditional circuit-switched voice and data methods. Some systems offer significantly enhanced capabilities compared to other telemetry methods. Potential advantages include two-way communication, more timely observations, and greater data rates and volumes.

Whichever satellite method is used, the sea level data will be sent via some kind of data collection platform (DCP) to the satellite operator and, it will be seen below, retransmitted eventually to the data owner via a suitable communications network. Thereafter, the data owner will need data storage and visualization tools in order to undertake comprehensive monitoring of the measurements.

One of the most widely used methods for re-broadcasting data to worldwide users is the Global Telecommunications System (GTS) (<http://www.wmo.int/pages/prog/www/TEM/GTS/>). The GTS was developed originally by the WMO and was intended mainly for meteorological data sharing between meteorological services around the world. Data can be transmitted to the GTS by any satellite or other communication method, with all resulting data made available at the national nodes of each country's meteorological service. The use of the GTS for the diffusion of sea level data was adopted by many operators following the Indian Ocean Tsunami in

December 2004, when Tsunami Warning Centres (TWCs) and other sea level network agencies realized that the system was highly reliable.

Additional progress occurred when IOC established a Sea Level Monitoring Facility (SLSMF) at the Flanders Marine Institute (VLIZ) (<http://www.ioc-sealevelmonitoring.org>) (Section 8.1.1). This facility provides a real-time monitoring service for any sea level station that is part of IOC programmes, such as the GLOSS Core Network or the tsunami warning systems in the Indian Ocean (IOTWMS), North East Atlantic and Mediterranean (NEAMTWS), Pacific (PTWS) and the Caribbean (CARIBE-EWS). The main objective of this facility is to enable the station owner to undertake a rapid assessment of the data availability and quality. Applications such as tsunami monitoring and warning are not part of the SLSMF's responsibility, and require additional data processing and decision making by the responsible national TWCs.

In the following sections, we describe the general principles with regard to choice of a telemetry system (Section 7.2), the particular systems used most often for sea level data telemetry (Section 7.3) including satellite and land-based systems (Sections 7.3.1 and 7.3.2). Section 7.4 provides some background to the GTS, while Section 7.5 refers to the telemetry hardware used at many sea level stations. Section 7.6 refers to the higher bandwidth requirements for the use of GNSS at tide gauge stations.

7.2 Choice of a Telemetry System

Selection of a communication system for RT or NRT sea level data transmission will be a compromise between several factors that have to be taken into consideration with regard to the intended application of the data. The main factors will include:

○ Transmission frequency and data rate

While the scientific use of sea level data does not usually require real time transmission, for emergency planning and response this feature is mandatory. The amount of data to be transmitted (the size of data packages) is also an issue and their size will depend on the data objectives. Scientific applications may (or may not) require large data packages, but emergency purposes usually rely only on smaller packages. In cases where large data packages are required, a higher data rate will also be necessary. Some systems allow different transmission modes, such that when an emergency occurs the transmission arrangements can be upgraded to provide higher data rates.

○ Reliability or system redundancy

Another important consideration is the reliability of data reception and this will also be directly linked to the data applications. For scientific applications, the reliability of data transmission can be complemented by in situ storage (i.e. local data logger), but for emergency purposes the reliability of the data transmission is the key factor. An assessment of the system's reliability must also take into account the possibility of many external influences, as emergency situations can change the normal operating conditions. Reliability issues include:

(i) Extreme weather or other emergency situations

In adopting a communication system for a tide gauge installation, one consideration has to be its reliability under severe environmental conditions. For example, for tsunami warning, a station may be positioned in a tectonically active region in order to provide an acceptable early warning. In the event of an earthquake, the first communications networks to be lost are often the PSTN networks and mobile telephone links, as well as electrical power. Under such circumstances, it is strongly recommended to use satellite links as the primary telemetry system.

(ii) Power redundancy and availability

Usually a photovoltaic power system, relying on input from solar panels during the day and batteries at night, will provide most power requirements for telemetry. An additional mains AC power supply can contribute to system reliability, but this should not be relied on for emergency applications.

AC power supplied by a cable can be interrupted during exceptional events. In locations where this is a possibility, it is essential to have additionally some form of uninterruptible power supply (UPS). This often takes the form of a battery back-up system with an adequate reserve capacity of several hours. Wind-driven power generators should be considered as a secondary power source only. However, at isolated sites with suitable wind conditions, a sea level station could benefit from the wind generator option for its overall power needs.

The power requirements of certain types of telemetry must be carefully considered. For example, BGAN (Broadband Global Area Network) transmitters to the INMARSAT satellites will drain batteries in a couple of days if not supported by AC power. Selecting longer

transmission intervals could lower their power demand but, as stated above, the application of the sea level data will determine if this is a suitable option.

Site location will not only determine the availability of telecommunication infrastructure and its power demands, but also the power availability for the sea level station itself. Sensor power requirements vary considerably, so appropriate sensor selection can help to lower power requirements.

In summary, if a user's applications require high-frequency or real-time transmission, with a high and reliable data rate, then the power requirements for the telemetry hardware will have to be met by a combination of one or more power sources. Near populated areas, AC power is certain to be available, but emergency situations will require the station to continue to work during power outages. At isolated sites and for emergency purposes, power requirements can be met by a combination of photovoltaic systems (solar panel/battery arrays) and wind-driven generators.

Once all these aspects have been considered (Applications, Transmission frequency and System redundancy), then an assessment of available funding will determine whether the station is feasible. Public satellite systems may be available free of charge as long as the user applies for a channel assignment and obtains approval from the owner of the system (see below). However, in situations where funds are not a constraint, private transmission systems will allow a greater flexibility for user needs. If funding allows, bidirectional (or two-way) communications with a sea level station is highly desirable as it can be used to update software or calibration values at the station, to interrogate the system for faults, to change the sampling rate, and to carry out many house-keeping functions that would otherwise have to await a site visit. This allows the system to be fully flexible and to improve overall reliability.

In conclusion, sea level data recorded near populated areas will have a vast array of telemetry options, from land based phone lines, radio, GPRS, public or private satellite networks. In this situation, factors such as transmission frequency, data rate, system reliability and cost will need to be analyzed to decide upon the optimum telemetry method. At more remote locations, then the availability of satellite systems and the constraints of their power needs will be relatively more important.

7.3 Data Transmission Systems

Once all previously described factors are taken into account, the user can take the critical decision of choosing a transmission system. As mentioned, in most cases a single telemetry system can be adopted but in others, in particular those related to emergency response, a redundant second solution will be desirable. A dual system approach will be determined not only by the objectives of the user but also by whether the tide gauge hardware allows simultaneous transmissions. Different transmission modes could be considered, with a primary system working in normal conditions, and a secondary one for emergency situations, with a different transmission frequency and/or data rate. In this section we provide more details of these different choices.

7.3.1 Satellite Systems

For scientific or emergency purposes, satellite telemetry systems are the more appropriate for sending data from a sea level station to a data processing centre. In some cases, the user may operate his own receiving antenna and Direct Readout Ground Station (DRGS), while in other cases the delivery of the data will be handled by the satellite system.

Delayed Transmission

Satellites operating in a low orbit can provide delayed transmissions from the tide gauge to the user each time the satellite passes over a receiving station. They can provide only a lower frequency of transmissions than for the other satellite systems described below, and data are received with some delay by the user. However, their main applications are in scientific research and monitoring where such constraints are acceptable.

The ARGOS system (<http://www.argos-system.org>) operates worldwide using polar orbiting satellites with an orbital period of about 100 minutes. A Platform Transmitter Terminal (PTT), with a data bandwidth capacity of 256 bits per satellite pass, is located at the gauge and, depending on location, the delay in data reception by the user may be several hours. Data are made available to users through the Argos Global Processing Centres at Toulouse, France and Largo, Florida. The number of accessible satellite passes per day is latitude-dependent, varying from about 7 at the equator to 28 at the poles. Users of ARGOS for tide gauge data acquisition include the Groupe de Recherches de Géodésie Spatiale

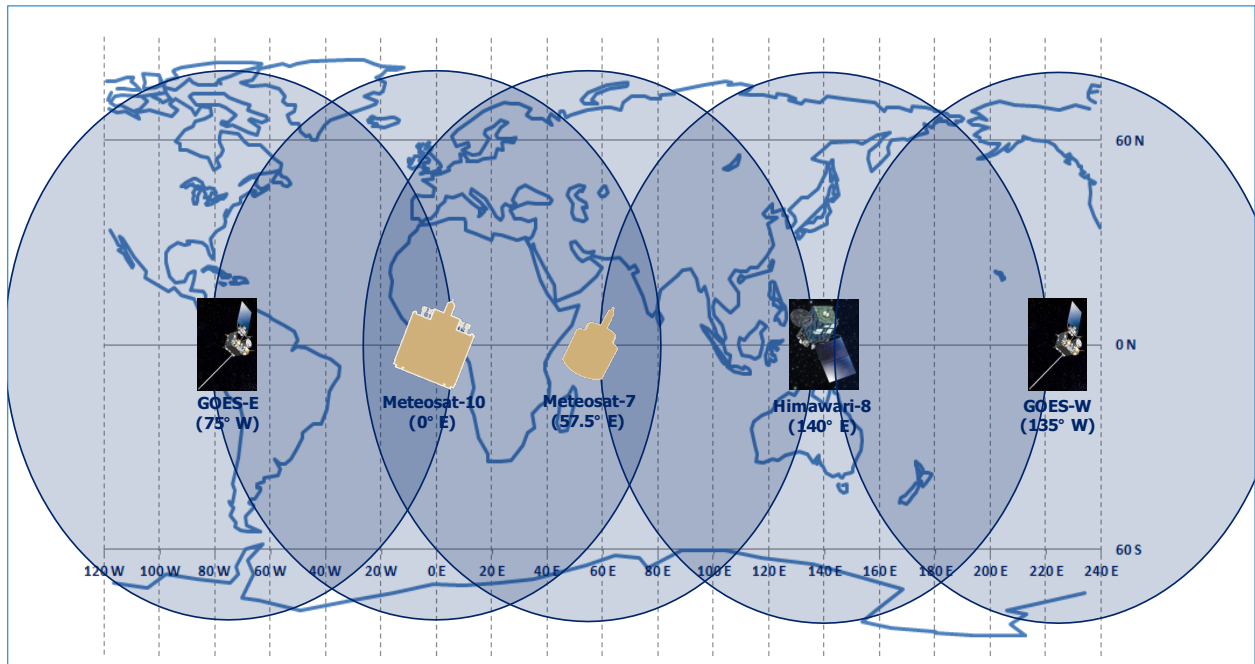

Figure 7.1 Coverage of the two NOAA GOES satellites over the Pacific and Atlantic, the two EUMETSAT METEOSAT satellites over the Atlantic and Indian Oceans, and JMA Himawari-8 over the Pacific. With regard to METEOSAT, this figure shows the situation as of 2016 with METEOSAT-7 at 57.5°E. This is planned to be replaced by METEOSAT-8 in 2017. (Figure from Sean Burns, EUMETSAT).

(GRGS), a consortium of 12 French research groups that will be able to provide advice to potential users.

Real Time Transmission

When the user's application requires a real or near real time transmission, geostationary orbit satellite systems are the best option, since the satellites are positioned permanently over the same parts of the Earth's surface. The set of geostationary satellites provides overlapping longitudinal coverage, but latitude cover is limited to about 75° N/S because of the equatorial orbit. Each DCP located at a gauge is allocated a fixed time transmission slot during which a given number of bytes of data can be transmitted to the satellite. The user must ensure that the DCP configuration allows the complete data message to be sent without exceeding the allocated time window.

GOES

<http://www.goes.noaa.gov>

The GOES (Geostationary Operational Environmental Satellite) system is available for government and scientific users and an application form needs to be sent to NOAA (as the owner of the system) for a transmission slot. Based on the user's objective, NOAA will allocate transmissions slots with particular transmission intervals and specific time-stamped transmission channels and windows. Two satellites, GOES-W (GOES-15) at 135 °W and GOES-E (GOES-13) at 75° W ensure a wide coverage of the Pacific

and Atlantic Oceans (**Figure 7.1**).

For emergency applications, high frequency transmission slots every 5 minutes can be allocated. For non-emergency purposes, 10 to 15 minutes intervals may be available. Users of these systems include NOC in the UK, NOAA and UHSLC in the USA, and some national tsunami warning centres in the Pacific such as that of SHOA in Chile. Once the application form has been submitted, the user will be allocated a transmission slot with the following parameters:

- DCP ID: Hexadecimal 8 digit code
- Channel number: Odd numbers are allocated for GOES-East and even numbers for GOES-West
- Time Start: Time at which the DCP is supposed to transmit, NOAA requires that the transmission be set at the start of the time window and not at the centre, to prevent a transmission overlapping another user's time frame.
- Time Window: Time frame available for the transmission

The data sent over this network can be directly received by the owners of the sea level station if they have their own DRGS. In other cases, the data will be received by NOAA's DRGS and sent to the owner via any available data transmission system, usually the GTS.

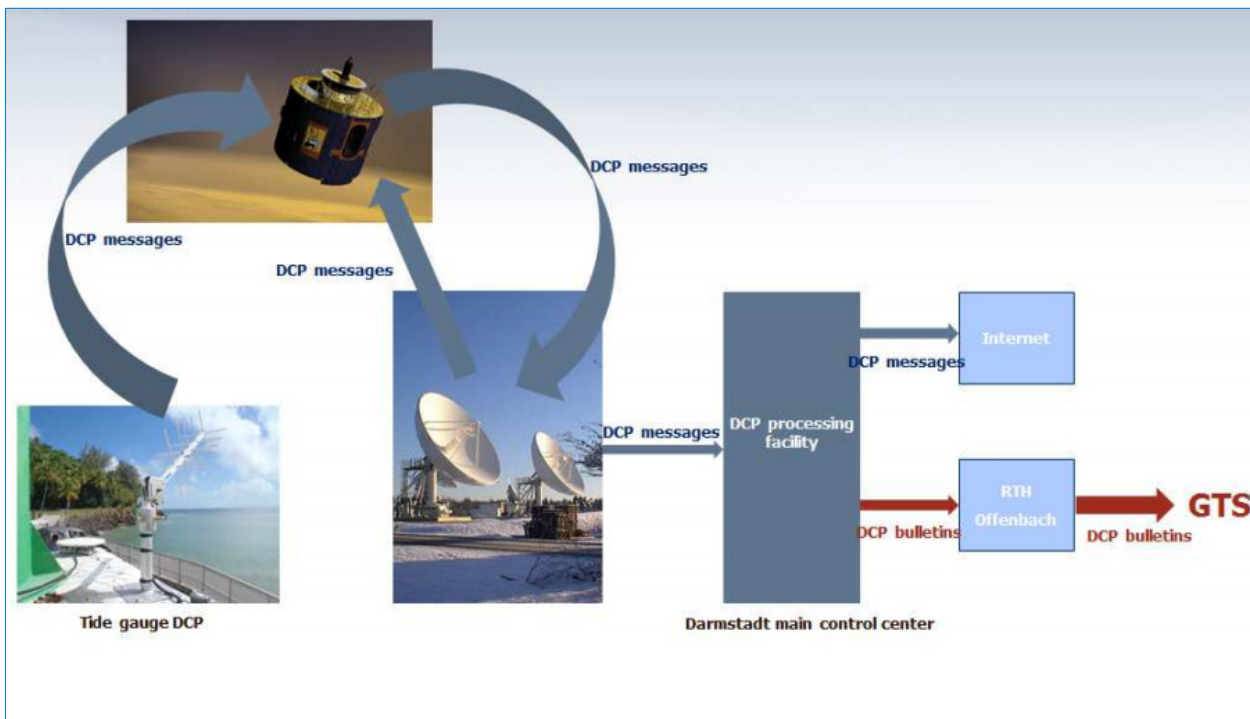

Figure 7.2 Schematic of METEOSAT data flow through to data arriving on the GTS. (Figure from EUMETSAT).

The GOES transmitter baud rate used to be either 100, 300 or 1200, but from May 2013 no new 100 baud rate slots have been assigned and users should now have migrated to High Data Rate (HDR) systems. All HDR transmitters are now required to use GPS to remove clock drift and to transmit only at 300 or 1200 baud rate. The improved efficiency of the HDR will allow more DCPs to function on each channel. Ultimately, HDR channels will have even more data throughput capability.

○ METEOSAT

<http://www.eumetsat.int>

EUMETSAT operates a number of satellites for operational meteorological and scientific purposes, of which the geostationary METEOSAT satellites are the most relevant to this chapter (Burns, 2009). A series of satellites have been operated, one set located on the Greenwich Meridian and so providing coverage of the Atlantic for Europe, Africa, Caribbean etc., and another at 57.5 °E for coverage of the Indian Ocean. They are able to provide sea level stations with a high frequency data transmission capability with transmitters located in many countries sending data to the Mission Control Centre (MCC) in Germany, which then delivers data to other users through EUMETCast, Direct Dissemination (for the 0° deg. satellite), Internet and the GTS. Among the more intensive users of this network within the sea level community, SHOM (France) has a wide experience with sea level stations located in

France itself, the Indian Ocean and the Caribbean.

METEOSAT can support two types of DCP. A Standard DCP transmits at 100 baud which can transmit 649 bytes of platform data in 60 seconds (including 5 seconds unmodulated carrier, preamble, sync code and address) with a timing accuracy better than +/- 15 seconds. A High Rate DCP (HRDCP) transmits at 1200 baud and can transmit 653 bytes of data in 10 seconds. The timing accuracy is improved to +/- 0.5 seconds. The minimum transmission length for the HRDCP is 15 second slots and, due to technical constraints, a maximum transmission slot of 60 seconds. HRDCPs are now operational; there is currently an HRDCP transmitter certified from one manufacturer and others are expected to be certified in the near future. Technical details of both types of DCP can be found in EUMETSAT (2013). In both cases, the network architecture can generate a delay between data transmission from the DCP and delivery through the GTS that can be up to 10 minutes (**Figure 7.2**). This 10 minute delay is the maximum through the system, but in practice it is much shorter. Any delay on the GTS network is, however, outside of EUMETSAT's control.

The introduction of the HRDCP allows for faster transmission rates and shorter transmission windows and so more flexibility and reliability for the users of the EUMETSAT Data Collection System (DCS). An HRDCP uses a forward error correction technique to give much

higher noise immunity and more robust reporting of data, thereby increasing the overall effectiveness of the DCS and its applications. The maximum message size has increased, allowing messages of up to 7343 bytes (within a standard 60 second time slot allocation) to be transmitted. The large code block size of an HRDCP, along with the possibility for message compression, means that two or more 'standard' DCP messages can be sent per transmission (e.g. current and previous), thus greatly reducing the need for explicit re-transmission for reliability. The HRDCP also supports binary data, an improvement on the Standard DCP.

Potential users of the system will need to comply with the EUMETSAT Data policy (<http://www.eumetsat.int/website/home/AboutUs/LegalInformation/BasicDocuments/index.html>). Users can request a channel allocation for METEOSAT in a similar way to the GOES system, choosing between three types of transmission: self-timed at regular intervals; an alert mode based on a predefined value for a parameter that should not be exceeded; or a combination of both types.

The standard reporting interval for the HRDCP is hourly but proposals for applications requiring more frequent reporting intervals, when supported with a valid justification, will be considered on a case-by-case basis. For example, France and Oman currently use 6-minute transmissions for tide gauge applications. With this high-frequency reporting, the Meteosat DCS is an alternative to systems such as BGAN or IRIDIUM, although one would not have bi-directional reporting.

Upon application acceptance by EUMETSAT, the users are allocated the following parameters that need to be programmed in their transmitters:

- DCP Address: 8 hexadecimal characters for DCP identification
- DCP Name: Chosen by the user, typically the name of the DCP location.
- Channel Frequency: A DCP will be assigned on one of the operational channels within the METEOSAT frequency range stated in the EUMETSAT (2013).
- Channel number: Number corresponding to the assigned frequency. The EUMETSAT numbering having changed recently, care has to be given when programming a radio transmitter that generally uses the old numbering format. DCP manufacturers are fully aware of the channel numbering change.

- DCP Allocation timeslots: Time at which the DCP will transmit (all DCPs have an accurate internal clock coupled with GPS synchronization)

○ MTSAT

<http://www.jma.go.jp/jma/jma-eng/satellite/>

The Meteorological Satellite (MTSAT) system provides similar meteorological and data transmission services to those of GOES and METEOSAT, but is located over the Pacific, thereby together providing global coverage (apart from the poles). The JMA has operated geostationary meteorological satellites since 1978, producing data that helps to prevent and mitigate weather-related disasters based on the monitoring of typhoons and other weather conditions in the Asia-Oceania region.

Until recently, the operational satellite was MTSAT-2 at 145 °E. However, JMA launched Himawari-8, its next-generation geostationary meteorological satellite, in October 2014 which became operational in July 2015 and replaced MTSAT-2 (**Figure 7.1**). Himawari-9 will be launched in 2016 as a backup and successor satellite. Both satellites will be located at around 140 °E, and will observe the East Asia and Western Pacific regions for a period of 15 years. JMA's Himawari-8/9 web page is <http://www.data.jma.go.jp/mscweb/en/himawari89/index.html>. Within the sea level community, the UHSLC and SHOM have experience of operating DCPs in the Pacific using MTSAT and/or GOES.

○ INMARSAT BGAN

<http://www.inmarsat.com>

The INMARSAT L-Band BGAN (Broadband Global Area Network) system provides a satellite-based equivalent to land-line broadband modems. It shares most of the advantages and disadvantages of conventional broadband, but is capable of operating in remote areas and is optimized for low power operation. BGAN's biggest advantage over fixed line broadband is its independence of local telephone infrastructure, and during extreme conditions it will most likely continue operating.

Contrary to the previous three satellite systems that are operated by government or public agencies, INMARSAT is operated by a private company that provides worldwide coverage, except for latitudes above 75°, with the use of three satellites in geostationary orbit (**Figure 7.3**).

The INMARSAT normal mode of operation involves the transmission of data from a site to a remote ground station, which then sends the data to the end user. This

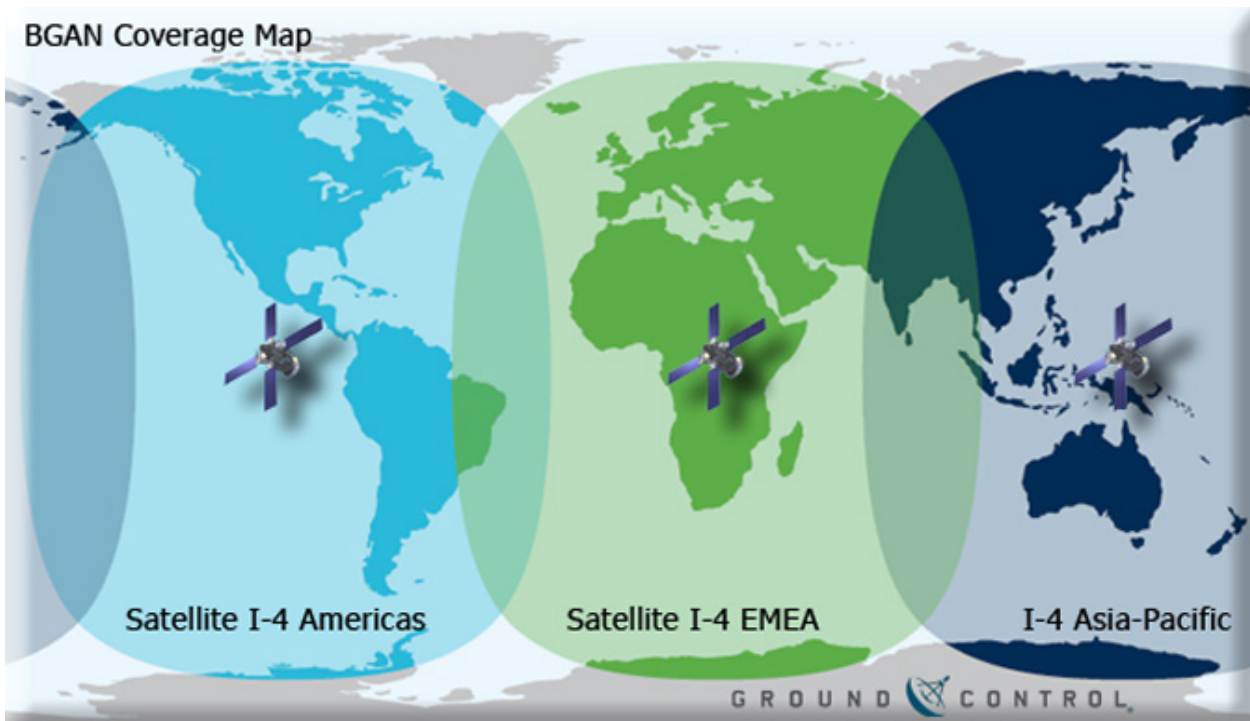

Figure 7.3 Schematic of INMARSAT BGAN coverage.

simple scheme requires a final link to the user that can rely on the GTS or the Internet as shown in Figure 7.4a. For most scientific purposes this network is quite adequate. However, for emergency purposes, when the land-based component of Figure 7.4a may be interrupted, data availability may be compromised.

A standard BGAN terminal communications session is normally initiated manually from the remote site. Newer BGAN M2M (Machine to Machine) terminals allow continuously maintained, two-way data communications enabling 24 hour control and monitoring of the remote station. Data can be sent either way using the BGAN Standard IP at a rate of up to 448kbps with a low latency of 800 milliseconds, assuring the real-time receipt of critical data. INMARSAT offers several alternatives but all of them rely on land-based communications to deliver data to the final user.

As an example, SHOA currently operates eight sea level stations that use BGAN as the primary or secondary telemetry. In these cases, the receiving antenna is not based at the INMARSAT receiving station but at SHOA Headquarters. This mode of operation, shown in Figure 7.4b, ensures that the sea level data never relies only on systems with land-based communication links, enhancing the system's reliability during emergency situations. The dual transmission links imply double the transmission costs. However, the important principle of

having one's own ground station is that the user should receive data as directly as possible, with no possibility of failure in an intermediate link.

○ IRIDIUM

<http://www.iridium.com>

This is a similar type of system to that of INMARSAT, but claims 'complete coverage (including oceans, airways and polar regions)'. It comprises a 'fleet' of 66 LEO satellites operating in a fully-meshed network. It serves a wide range of commercial, governmental and social sectors, and designs and sells its own equipment through a world-wide network of more than 100 partners. IRIDIUM specifically offers data-transmission services via laptop and cellphone world-wide, including very remote areas. Data services through dedicated IRIDIUM transmitters are also widely used. Data transmission over IRIDIUM usually uses Point-to-Point Protocol (PPP) or Raster-based Unrestricted Digital Internetworking Connectivity Solutions (RUDICS) protocols.

NOAA make use of IRIDIUM for a small number of remote stations, mainly those where either GOES transmissions are impossible or unreliable, but more often to have two-way communication capability to conduct diagnoses of problems, thus avoiding a costly maintenance trip and minimizing downtime. However, unlike GOES, there is a cost associated with using IRIDIUM, which is why it

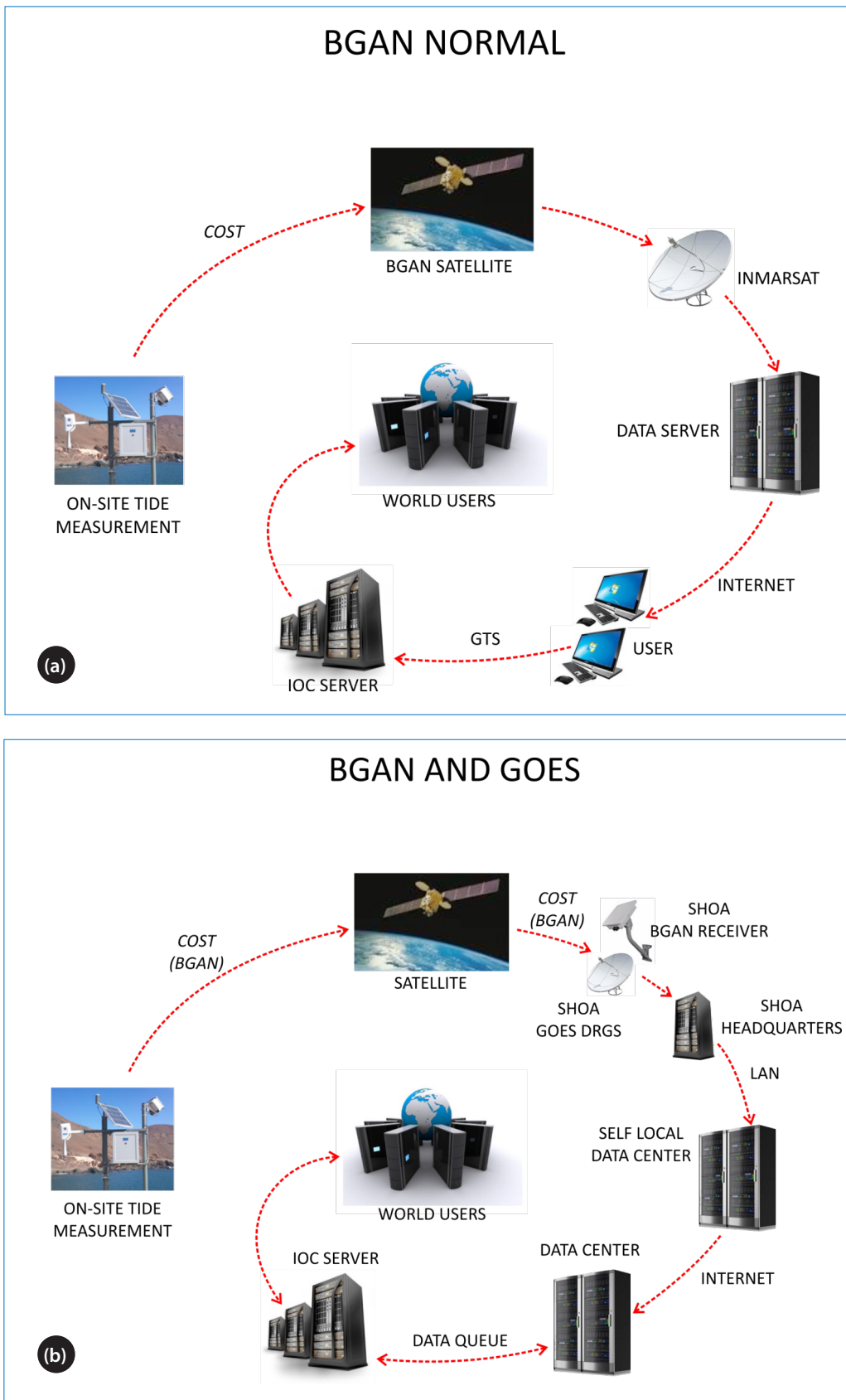

Figure 7.4

(a) Route of sea level data by means of BGAN from tide gauges to data centres.

(b) Inmarsat BGAN direct data reception implemented at SHOA alongside GOES reception (GPRS reception follows a similar path). COST indicates that a transmission cost may be involved.



Figure 7.5 A VSAT dish alongside a tide gauge in Indonesia. This station is also equipped with an OTT Kalesto radar gauge and GPS receiver. (Photograph Tilo Schöne, GFZ).

is used only in certain situations. Amongst other users, UHSLC use IRIDIUM for transmission of GNSS data at tide gauges but not for the gauge data itself. GFZ have used IRIDIUM for tide gauge data in Indonesia. There have been some reports that IRIDIUM and GNSS signals can interfere in some circumstances, and this possibility should be checked for each installation.

○ VSAT

VSAT (a Very Small Aperture Terminal) is a two-way satellite ground station with a dish antenna smaller than 3m (1.6m being typical for tide gauge operations) that provides direct high rate, two-way communication between a monitoring station and data centre (see https://en.wikipedia.org/wiki/Very-small-aperture_terminal). VSAT has had limited application in the global sea level network. Installations were made at two stations in Indonesia (in cooperation with GFZ, Potsdam), primarily for streaming of GPS, rather than tide gauge data (**Figure 7.5**). However, these VSAT installations have since been replaced by BGAN. The Survey of India has established a central station with VSAT capabilities at Dehra Dun in order to receive real-time GPS and tide gauge data from its remote gauge sites.

○ ORBCOMM

<http://www.orbcomm.com>

Section 5.3 of the Volume 4 contained a review of satellite data transmission systems that could be used for sea level data as of 2006. To our knowledge, the only system, additional to those referred to above, that has been used for sea level data transmission since that time has been ORBCOMM which was used for some years by NOC, UK. ORBCOMM consists of a space segment of LEO satellites with ground segments called Gateway Earth Stations or Gateway Control Centres. NRT communications were possible from some areas. However, in other areas such as Africa and the Indian Ocean there was a delay of several hours while data were relayed to an ISP, necessitating a change to other methods (e.g. METEOSAT). We know of no sea level measurements now being transmitted using ORBCOMM, although it is still a possible option.

○ INMARSAT Global Xpress

<http://www.inmarsat.com/service/global-xpress>

INMARSAT Global Xpress (GX) is a new high-speed broadband satellite network similar in operation to BGAN but operating in the Ka-band, enabling more compact user terminals to be employed. It will offer downlink/



Figure 7.6 A compact local radio transmitter antenna at Antofagasta, Chile. (Photograph SHOA).

uplink speeds of up to 50 Mbit/sec and 5 Mbit/sec respectively. The GX constellation is formed of three Ka-band, high-speed mobile broadband communications satellites, each with an expected life of 15 years. Three satellites provide the required coverage for global GX services: I-5 F1 for Europe, the Middle East, Africa and Asia; I-5 F2 for the Americas and the Atlantic Ocean Region; I-5 F3 for the Pacific Ocean Region. This new service may provide future opportunities for ‘real-time’ interaction and diagnostic sessions with tide gauge instrumentation at remote sites. In addition, it should enable the retrieval of larger GNSS data sets and remotely-stored, long-term sensor data.

Table 7.1 summarises the information on each satellite system. For more information on satellite communication methods in marine science, there are several reports that have been written for IOC and JCOMM working groups that review and compare the various available systems (e.g. Prior-Jones, 2011; Meldrum, 2013). These unpublished reports may be obtained from IOC.

7.3.2 Land-Based Systems

Land-based systems offer the advantage of being able to provide a transmission interval according to the user’s needs. Transmission costs are usually fixed and less expensive than satellite-based networks. The required components to implement this technology are less sophisticated and readily available from local service providers.

Nevertheless, all these systems rely heavily on land-based infrastructure for transmission to the user, which may be interrupted during an emergency. Consequently, this type of telemetry is not suitable as a primary telemetry system for emergency response agencies.

Radio and Wi-Fi

Line of Sight (LoS) radio provides an economic approach to sea level data telemetry between two points with a clear line of sight between them, but is not suitable for more distant locations due to power requirements. These systems operate in non-commercial, service and aviation bands in the HF/VHF/UHF spectrum, generally

Table 7.1

Satellite data transmission systems mentioned in Section 7.3.1. For information on systems used for other marine data (e.g. Inmarsat C and D+, Globalstar etc.) see Meldrum (2013). Systems are listed in approximate order of increasing bandwidth. Latency means the likely delay in data reaching a data centre. 1-Way indicates that data flows from the tide gauge to the data centre only, with no possibility of interaction with the tide gauge by the user. 2-Way indicates that a user can also communicate with the tide gauge data logger. Costs are given as an approximate guide only and are shown in US dollars. Endpoint indicates the mechanism by which the data are made available to the user. GPRS is listed at the end of the table for comparison to the satellite systems.

System	Basic application	Orbit type	Bandwidth	Latency	1 or 2-Way	Equipment Costs	Recurrent Data Costs	Endpoint
ARGOS	Messaging	LEO	< 5 kbyte/day	Several hours	1	1500 for beacon	200 per year subscription + 1000 per year transmission cost	ARGOS server accessed by the user.
GOES, METEOSAT, MTSAT	Messaging	GEO	< 5 kbyte/day	Several minutes	1	3700 for DCP, antenna, mountings etc.	Free for WMO programmes	GTS
ORBCOMM	Messaging	LEO	< 50 kbyte/day	Several hours	2	200-300 for modem terminals	60 per month	Email server
IRIDIUM	Voice, but data modems only are adequate to access sea level data	Big LEO ¹³	1 Mbyte/hr	Near Zero	2	2000 for modem and antenna	22 per month + 1.2 per minute for data only mode	User modem
INMARSAT BGAN	Broadband	GEO	492 kbits/s	Near Zero	2	1000 for antenna	Depends on contract.	Internet
VSAT	Broadband	GEO	4 kbits/s to 16 Mbits/s	Near Zero	2	3000 for router, antenna and cables	Variable rates depending on data volumes.	Internet
INMARSAT Global Xpress	Broadband	GEO	50 Mbits/s download and 5 Mbits/s upload	Near Zero	2	To be announced	To be announced	Internet
GPRS	Messaging	-	56-114 kbits/s	Seconds	2	350 for handset and modem	Comparable to mobile rates in each country	Internet

¹³ LEO systems can be divided into Little and Big LEO. Little LEO systems make use of small satellites providing mobile data and messaging services. They are used for data gathering, electronic facsimile, two-way paging and electronic mail. Big LEO systems make use of larger satellites which provide some or all of these services in addition to real-time voice.

from 27MHz to 915MHz. Other available systems such as WiFi, Bluetooth and ZigBee allow electronic devices to connect to a local network, operating in the 2.4 GHz and 5 GHz bands, though only more sophisticated data loggers may be compatible. If the end user is located near to the tide gauge, these techniques may be useful. However, if the user is located far away, then some kind of additional telemetry will anyway be required, which negates the initial benefit of the use of the LoS radio or Wi-Fi. In populated areas, the use of this technology must face additional constraints due to obstructions in the line of sight and an overcrowded radio frequency spectrum that may cause transmission interference. **Figure 7.6** shows a compact radio antenna at Antofagasta, Chile.

Internet

There has been a major increase in the uptake of broadband services globally, even at remote islands such as those of NOC's South Atlantic network. Leased lines, offering continuous, high-speed Internet access are available on all these islands except Tristan da Cunha. NOC has developed instrumentation that can take the output from a range of sensors, including radar and pressure types. The data are collected by a small Linux-embedded processor and sent back to base by email or by Secure Copy Protocol (SCP). Broadband-enabled test sites using a radar sensor connected to an embedded Linux system have been employed at several sites (Holgate et al., 2008).

The 39 tide gauges of the REDMAR network of the Spanish Ports Authority use a similar system, with one-minute data values available every minute in the form of an email message. This network is based on radar sensors and data are displayed on the Authority web page (<http://www.puertos.es/en-us/oceanografia/Pages/portus.aspx>), the IOC SLSMF and other European data portals.

The advantages of broadband internet technology are:

- Continuous two-way connection allowing high-speed data sampling and near-real-time data retrieval. Remote tide gauge diagnostics are thereby possible, as can be an ability to re-program the system remotely.
- Timing drift and operator setup errors are eliminated by having an accurate time available from network time protocol (NTP) servers on the Internet.

- Data delivery costs are known in advance because subscriptions are paid monthly or annually.
- Real-time data collection allows malfunctions to be identified and fixed more rapidly.
- Fixed-line broadband systems can also allow backup access through a dial-up modem.
- The disadvantages of broadband technology are:
 - A Local Area Network (LAN) interface is required and this is often difficult to add to existing tide gauge systems. A land line is necessary for non-satellite broadband systems.
 - In less sophisticated dataloggers, a LAN interface port is generally not available, so interfacing is more difficult.
 - Power requirements for broadband modems are quite high (~1 amp) and this can create problems for systems powered by solar power only.

GPRS

One of the most widely-used telemetry options in populated areas is provided by low-power GPRS modems that employ part of the band used by mobile phones to connect to the Internet. Data can be sent to a specific IP or domain and the transmission costs are usually fixed and do not depend on the amount of data sent. This telemetry option relies on the land-based Internet for data to be received by the final user unless the GPRS network supports static IP to enable a GPRS modem to act as a receiving antenna.

As an example, SHOA currently operates 37 sea level stations that use GPRS as the secondary method of telemetry, and during earthquakes, that have caused interruptions on cellphone communications, this technology has demonstrated a good performance. Many more stations are operated by GPRS in other countries e.g. in Indonesia for tsunami warning. Once data have been delivered over the Internet by the telephone companies, the data can be shared with the rest of the community using data centres that are located in foreign countries, thereby enabling continued operations if a local data centre suffers damage. This data redundancy follows a similar route to BGAN and GOES data as shown in **Figure 7.4b**. The REDMAR network in Spain has now moved to the use of GPRS for most of its stations.

7.4 Broadcasting Telemetry (the GTS)

A distinction must be made between the transmission telemetry from the tide gauge to the user, for which several methods have been described above, and the broadcasting telemetry used for sharing these data with the rest of the community. The Global Telecommunication System (GTS) is the most usual method for such data sharing. It is defined as: "The co-ordinated global system of telecommunication facilities and arrangements for the rapid collection, exchange and distribution of observations and processed information within the framework of the World Weather Watch". It can be thought of as a 'specialist internet for meteorological applications' and is the responsibility of the WMO (<http://public.wmo.int/en/programmes/global-telecommunication-system>).

As an example, we can consider a tide gauge equipped with a DCP that transmits to a METEOSAT satellite. DCP messages are retransmitted from the satellite, received at a ground station and then passed immediately to the European Organization for the Exploitation of Meteorological Satellites (EUMETSAT) Main Control Centre (MCC) in Darmstadt, Germany. At the MCC, the messages are processed and distributed to users, and are also sent to the GTS Regional Telecommunication Hub (RTH) interface in Offenbach, Germany. The data are then disseminated on the GTS in the form of bulletins that can be received by any registered organisation such as the TWCs and national meteorological offices.

Similar DCSs to that of EUMETSAT are operated by NOAA, JMA, the China Meteorological Administration, the Indian Space Research Organization and Roshydromet (Russia). In a similar way to transmissions through METEOSAT described above, users of the GOES system who do not operate their own DRGS can rely on the GTS to receive their data from NOAA. In this case, the Wallops Command and Data Acquisition Station (WCDAS) acquires, maintains, and distributes a continuous flow of meteorological satellite data through several communication networks. WCDAS directly inserts data into the GTS for distribution to users across the world.

It is important to note that tide gauge data need not be transmitted through a satellite in order to be made available to the GTS. Data can be sent by any method (e.g. standard telephony) to a national meteorological service, which will forward the data to the GTS. The IOC SLSMF currently displays data for more than 850 sea level

stations around the world, many of which use the GTS as the primary network for data broadcasting. A large number of the latter (especially from Japan, Australia and French Antarctic sites) make use of a meteorological service rather than a satellite DCP method. If a non-standard form of telemetry from the tide gauge is used, then special transmission arrangements with the national meteorological organizations will be needed.

To enable the routing of DCP data via the GTS, the DCP messages must adhere to the formats, structures and procedures as defined by the WMO. A GTS bulletin contains a set of information as described in Appendix 3 which is extracted from Poffa (2014).

CREX (Character form for the Representation and Exchange of meteorological data) is a table driven code approved by the WMO for the representation and exchange of observational data. A table driven code means that the form and content of the data contained in the message are described within the message itself. A formal description of the code and an extensive listing of associated tables can be found in documents accessible from the WMO website. The reader may also refer to BOM (2006) and NOAA (2013b) which accurately describe tide data CREX descriptors and provide message examples. An example of CREX message generated by a DCP is given in Appendix 3.

7.5 DCP and Other Telemetry Equipment

Data Collection Platforms

Transmitting data through most of the satellite systems describes above requires a Data Collection Platform (DCP). The DCP consists of a radio transmitter and a suitable antenna and is interfaced to the tide gauge data logger and the environmental sensors, including the tide gauges, via serial connectors using Binary, ASCII or Pseudo-binary data formats. A GPS receiver will provide accurate timing to the datalogger and DCP, but the system should allow for operation of up to one month without a GPS time synchronization. The DCP transmitter will be a rugged instrument with an RF output for the transmitting antenna (**Figure 7.7**).

A DCP will often be required for unattended operations at remote sites that do not have mains power. Such sites that provide tsunami alerts may use sensors such as radar gauges that transmit data at high frequency. In these

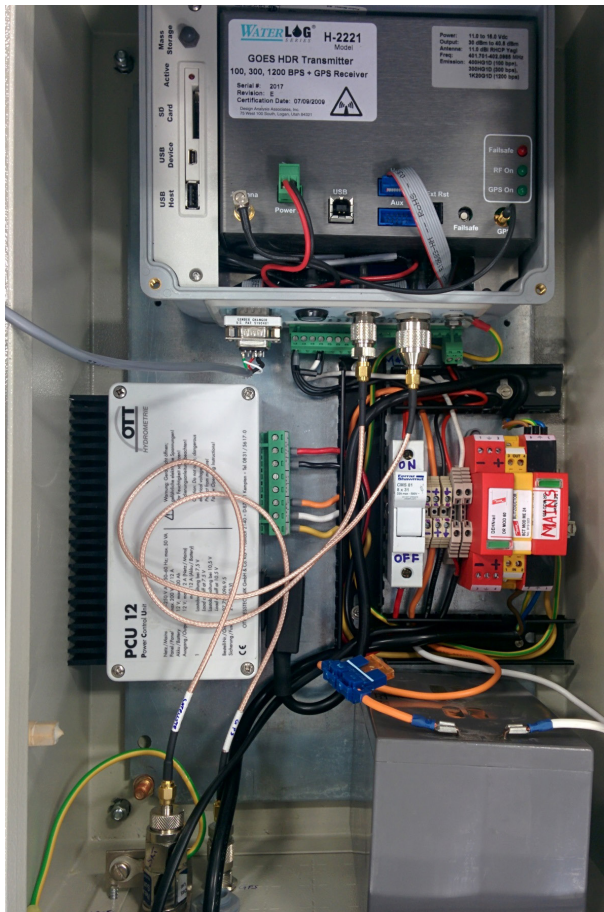

Figure 7.7 The inside of a tide gauge electronics cabinet. A Waterlog GOES HDR transmitter is shown at the top of the cabinet while the lower part contains a power supply and back up battery. The data logger is located behind the HDR. (Photograph NOC).

cases, as explained above, it will be necessary to use a DCP with low power consumption.

A tide gauge station can be considered as an interface to one or more sea level sensors, ancillary sensors, datalogger and telemetry devices such as a DCP. It will require a reliable power supply that can serve all the components. There may be other telemetry devices besides the DCP, including UHF/VHF antennas or GSM/GPRS modem. In addition, there may be GNSS equipment. Depending upon which manufacturer is chosen for each of these many components, it may (or may not) be straightforward to assemble them altogether.

The datalogger and DCP should be selected to interface readily with each other and with the various sensors using suitable cables and connectors that allow for quick and trouble free integration. Usually, manufacturers provide software to manage the system and set up the configuration in which the sensor measurements, statistical processing, data logging and data transmissions are performed. Some dataloggers are capable only



Figure 7.8 A GOES Yagi antenna. The small hemisphere on the top of the support post is a GPS antenna for time control. (Photograph NOC).

of interfacing with particular DCPs, while others can support multiple dataloggers and telemetry options. This is an important aspect when it is necessary to include multiple telemetry methods to strengthen the resilience of the station in emergency situations. Therefore, ideally the datalogger and DCP should provide interfaces with almost any kind of telemetry and sensors. The best dataloggers have sufficient ports to enable RS-232, RS-485 and SDI-12 connections. In addition, connections can be made to a LAN network using Ethernet devices while other options for telemetry include wireless, landline and satellite devices.

Depending on the site characteristics, most of the components of the station, including the DCP, can be mounted on supporting structures installed outdoors, with the main electronic components installed inside enclosures that meet certain standards of protection against the weather and other environmental agents. However, it is more usual to find sea level stations where elements of the power supply system, datalogger and other electronic components are mounted inside a tide

house, leaving outside the antennas, solar panels and hydrological-meteorological sensors.

Anyone wishing to use one of the satellite systems to relay DCP messages is required to operate with a certified DCP radio transmitter. Some manufacturers supply the satellite transmitter for single satellite systems. However, dataloggers and satellite transmitters that allow the user to employ multiple systems (GOES, METEOSAT, INSAT, SCD or ARGOS) are also available. The higher baud rate transmitters not only offer a faster throughput of data, but result in more users able to transmit data via the same satellite.

DCP antennas can be either directional or omnidirectional. One of the most commonly used at sea level stations is a Yagi directional antenna with a gain of 11.0 dB (Figure 7.8). This kind of antenna must be aligned at the proper azimuth and inclination so as to point towards the assigned satellite. Normally, manufacturers provide the antenna with a 'U'-bolt mast mount, and a cable to connect the antenna to the transmitter. Depending upon

the model and the baud rate used, the output power during transmission will range between 5 and 12 W.

BGAN Terminals

The INMARSAT BGAN satellite system enables data transmissions from tide gauges on a global basis. The system is fully operational and offers several services. One of these is the transmission of data, and for a fixed field platform it is necessary to use the proper terminal/antenna. For this purpose, there are various small and lightweight satellite terminals available, providing performance options to suit different operational needs.

Most of them comprise a single unit incorporating a transceiver and an integral antenna in a compact design. The terminal is easy to use, requiring an Ethernet interface while terminal control buttons and LCD allow the user to monitor its operation. As for other systems with satellites in geostationary Earth orbit, it is necessary to point the antenna towards the proper INMARSAT satellite.



Figure 7.9
(a) A Thrane & Thrane Explorer 300 BGAN terminal. (Photograph NOC).

The user accesses the system via an activated 3G compatible SIM card which is installed inside the terminal. It is necessary to sign a contract with a provider of BGAN Managed Solutions, which usually not only provides the service but also supports and optimizes the interface with the field station.

Some antennas, such as the Thrane and Thrane Explorer 300 (Figure 7.9a,b), allow a user to send data at up to 384kbps and to receive data up to 240kbps over a shared channel using a standard IP. Occasional loss of satellite connection can be handled by manual intervention or by using regular (e.g. daily) restarts of the system.

The Hughes 9502 M2M terminal is another packaged solution for adding real-time IP communications to a remote station. It includes all the hardware needed to get started. Like other terminals, a power source and Ethernet-capable datalogger or peripheral must be added. The equipment needed also includes a directional antenna, antenna cable, mounting hardware, and all

cables needed to connect the terminal to the datalogger and power supply.

The main advantages of using a Hughes 9502 are a stronger gain antenna, reducing the probability of a lost link with the satellite, bi-directional communication enabling remote diagnostics and reset from the user. Using this terminal, no manual intervention is required to recover from a lost link with the satellite, due to an integrated IP watchdog that ensures “always-on” network connectivity and complementary auto-on/auto-context activation, that automatically restores power and connection following loss of power and/or IP connection.

The data transmitted through the INMARSAT satellite system is generally received at an Earth gateway station and managed by the provider of the service for later transmission to the users via the Internet. However, it is also possible to receive the field-collected data directly in the facilities of the user, for which it is necessary to install a local BGAN antenna transceiver connected to the end



Figure 7.9

(b) A similar BGAN terminal at Taltal, Chile. The antenna (also a T&T Explorer 300) is in the box on the top right of the photograph. (Photograph SHOA).



Figure 7.10 A typical GPRS modem as used in Chile.

user computer (**Figure 7.4b**). The latter option ensures a robust communication with the sea level station as it does not rely on data reception at a BGAN/INMARSAT ground station and subsequent internet transfer of data to the end-user, which is the normal data flow adopted by users of this network. However, this approach doubles the transmission costs as the user has to pay for data being sent to the satellite as well as data being sent from the satellite to the final receiving antenna.

Cellular Modems

Many dataloggers support GSM/GPRS modems to provide wireless telemetry over a GSM/GPRS mobile network, and many loggers have a GSM/GPRS/3G/4G modem built into them. Usually they can interface into the tide gauge system in a straightforward way, being manufactured with standard industrial interfaces and integrated SIM card readers. It is preferable to choose a GSM terminal with the GPRS (General Packet Radio Service) capability, so that when it is used with the suitable modem the data can be sent via the Internet through a wireless TCP/IP connection. It is recommended to choose a modem that has received full type approval (FTA) from the main operators so that it can be used anywhere. The tide gauge hardware will need a terminal block to provide connections from the modem to a power supply and the antenna. As an example, **Figure 7.10** shows a typical GPRS modem.

7.6 GNSS Data Transmission Requirements

The use of GNSS at tide gauges as described in Chapter 6 requires a higher bandwidth for data transmission than for the tide gauge data itself. Most GNSS services, such as the IGS or the IGS TIGA Working Group or national mapping agencies, process GNSS data obtained with a 30 sec sampling rate. For very remote installations with low-bit communication, 120 sec sampling rates can be used to obtain daily position estimates although they are not optimal. More recent GNSS installations with sampling rates of 1 Hz or higher allow for a broader range of applications, such as in GNSS reflectometry or GNSS seismology (Section 6.6).

For the standard application of 30 sec sampling, with some reduction of unnecessary parameters, the volume of data to be transmitted is approximately 18MB/month, a number which can be scaled to other sampling rates (e.g. 120 sec) if required (this statement is correct at least for the use of GPS data alone, proportionately higher rates may be needed if more than one GNSS technique is employed). In this case, a daily or more frequent upload of GNSS data, preferably as RINEX files, is necessary to assist in most applications. For the 1 Hz sampling then data volumes become several 10s of MB/day.

In populated areas, a connection of the GNSS receiver to the Internet is the most convenient method for data transmission. Sometimes a short-range radio or Wi-Fi connection may be used as a bridge between the tide gauge and the nearest Internet access point. In locations without local support, GPRS is frequently used to upload data and manage the GNSS receiver. However, satellite communications systems can also be used, and remote locations can make use of BGAN, VSAT or IRIDIUM as for tide gauge data (although with reduced data rates for the latter).

8. Sea Level Data

8.1 Sea Level Data Centres

There are several international sea level data centres. They play different roles in providing the overall global sea level data set (Table 8.1). However, each centre works closely with the other centres, thereby maximizing the quantity and quality of the data that can be made available to scientists and others interested in sea level. The GLOSS Implementation Plan 2012 (IOC, 2012) explains how the centres are cooperating in the development of an effective centralized GLOSS web service for all sea level data and metadata.

However, it is incorrect to say that the centres are concerned only with the GLOSS programme. Most of them receive, quality control, data bank and redistribute data from tide gauges that are both GLOSS and non-GLOSS. In the context of the present Manual, we encourage all operators who have established good

radar tide gauge stations to make their data available to each data centre.

There can be said to be three types of data provided by a tide gauge, and each type will map into one of the centres described below:

- Real or near-real time data (RT and NRT data). These data are required for operational purposes such as port operations, storm surge flood warning or tsunami identification. There is no requirement for, or little possibility of, rigorous quality control (QC). Such data are sometimes monitored by experienced personnel who are able to judge whether any data anomalies are real or due to instrument malfunction.
- Fast data. These data are required on timescales of weeks and so could be subjected to some quality control. Fast data are required for applications such as satellite altimeter data validation.

Table 8.1

Sea Level Data Centres

	Location	Role	Data Availability	Web site
Monitoring facility	IOC SLSMF	Plots and downloads of NRT raw data	4-6 weeks	www.ioc-sealevelmonitoring.org
Fast mode	UHSLC	Preliminary QC of data from originators		uhslc.soest.hawaii.edu
Delayed mode	BODC	Final high frequency data from originators	Annually	www.bodc.ac.uk
Hourly data products	JASL/UHSLC	Final hourly data with corrections	Annually	uhslc.soest.hawaii.edu
Monthly averages	PSMSL	Final monthly averages from originators	Annually	www.psmsl.org
GNSS data	SONEL	Archive for GNSS data near tide gauges	Daily	www.sonel.org

The above web sites contain information from locations around the world. The PSMSL web site also contains a list of many national and regional sources of real-time and delayed-mode sea level data.

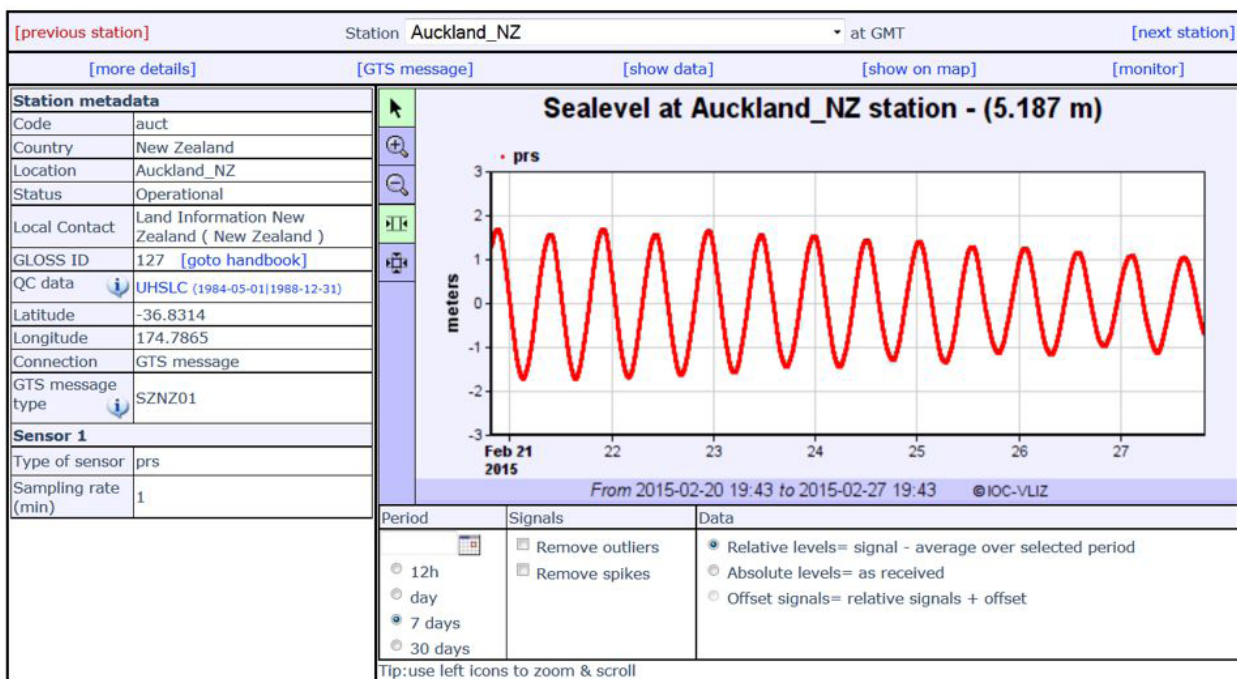

Figure 8.1 An example of the operational status of a tide gauge station displayed by the IOC Sea Level Monitoring Facility.

○ Delayed mode data (DM data). These data have been inspected thoroughly and been given flags to show a user whether they are good, suspect or bad. The main application of delayed mode data is scientific research.

8.1.1 The IOC Sea Level Station Monitoring Facility (for RT and NRT Data)

The Flanders Marine Institute (VLIZ, Belgium) hosts a web-based Sea Level Station Monitoring Facility (SLSMF, <http://www.ioc-sealevelmonitoring.org>) on behalf of IOC, for viewing sea level data received in real-time from different tide gauge station operators via the Global Telecommunications System (GTS) or other communication channels. The operational status of each station can be readily assessed by operators through quick inspection of the raw data stream (Figure 8.1). In addition, the operational status of all stations is checked weekly by the SLSMF, and station operators are contacted if stations are failing. All tide gauge operators, associated with GLOSS or other IOC programmes, are encouraged to send their data to the SLSMF, even if they undertake their own real-time monitoring (see also Section 8.2.1).

The SLSMF also provides a web-service for direct data access. However, these raw data records are not subject

to any QC and should not normally be used for science. The intention is for the Facility to work with the proposed GLOSS High Frequency Data Centre to ensure that these high-frequency records are included in another accessible database that involves some QC.

The Facility has also developed a catalogue system that links the various sea level station metadata repositories, which is an important step towards the centralized web service mentioned above. The PTWC, UHSLC and PSMSL/ GLOSS Handbook metadata systems are already linked, and that for TIGA will be linked soon (see below for some of these activities).

8.1.2 GLOSS Fast Delivery Centre (for Fast Data)

The GLOSS Fast Delivery Centre is operated by UHSLC (<http://uhslc.soest.hawaii.edu/>) and has the responsibility for assembling and distributing sea level data sets that have undergone preliminary quality control by data originators. 'Fast delivery' implies making received data available within 4-6 weeks. The UHSLC provides Fast Delivery quality control services for Member States that do not have that capability. See further remarks on 'fast' data in Section 8.2.1.

8.1.3 GLOSS Delayed Mode Data Centre (for DM Data)

The GLOSS Delayed Mode Data Centre is operated by the British Oceanographic Data Centre (BODC, <http://www.bodc.ac.uk>) in collaboration with PSMSL. It has the responsibility for assembling, quality controlling and distributing the 'final' versions of sea level data sets, as well as all supporting metadata information, from GLOSS sites only. It is structured to provide hourly (or sub-hourly) values, together with ancillary variables (e.g. atmospheric pressure) where these are available.

It is important for GLOSS to archive sub-hourly data, rather than for example the derived hourly values, where the former comprise the raw measurements. Sub-hourly data could also be important to scientific analysis of processes such as tsunamis, meteotsunamis and seiches that are not possible with hourly data. Data contributors to the Centre are required to make their records in the year following the data-year together with comprehensive metadata (including benchmark information).

In collaboration with IOC, the BODC, with assistance from PSMSL, provides an essential coordination role for

GLOSS, including the production of the GLOSS Station Handbook, a data set containing descriptions of each GLOSS tide gauge station. The Handbook is available from the GLOSS web site (<http://www.gloss-sealevel.org>) which is maintained by BODC and provides a focus for the GLOSS programme.

8.1.4 The Joint Archive for Sea Level (for DM Data)

The Joint Archive for Sea Level (JASL) is a collaboration between the UHSLC and the US National Oceanographic Data Center (NODC). The JASL acquires hourly datasets from GLOSS and non-GLOSS tide gauges from around the world that have received a final quality assessment from the data originators. JASL provides an independent check of the data, primarily to identify any remaining outliers, timing issues, or datum shifts. Any quality issues with the data are brought to the attention of the data originators for reconciliation. JASL then assembles a single hourly time series for each station, or a series of sub-records if datum changes occur over time. The JASL dataset therefore represents a 'data product', as problematic data points are not simply flagged and left in

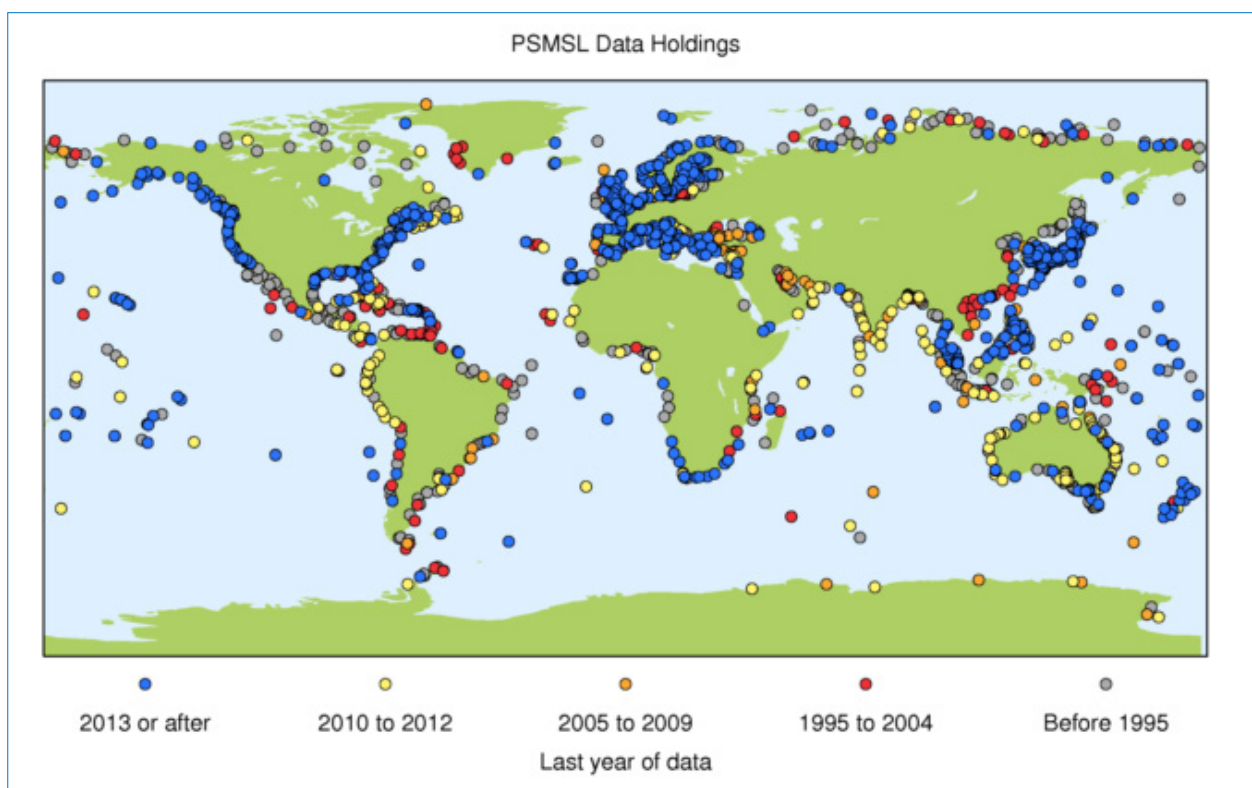

Figure 8.2 Status of PSMSL data holdings (dated 2015). The coloured dots indicate the last year of data received.

the records, as they are by BODC for the GLOSS Delayed Mode Dataset, but are actually changed to best assessed values by JASL. Any changes are documented in the metadata information.

8.1.5 GLOSS High Frequency Data Centre (for DM Data)

The GLOSS Implementation Plan (2012) has proposed that a GLOSS High Frequency Data Centre be established with close ties to the other GLOSS data centres. The GLOSS-HF centre will import all high frequency datasets that have been quality assessed by the originator. While the primary focus will be on GLOSS stations, the centre will be encouraged to include all high quality datasets that are of research quality, particularly in support of tsunami and storm surge analyses.

8.1.6 Permanent Service for Mean Sea Level (for DM Data)

Since 1933, the Permanent Service for Mean Sea Level (PSMSL, <http://www.psmsl.org>, Holgate et al., 2013) has been responsible for the collection, publication, analysis and interpretation of sea level data from the global network of tide gauges. It is based at NOC in Liverpool and operates under the auspices of International Council for Science (ICSU) and is a member of the World Data System (WDS) of ICSU. At the time of writing, the PSMSL database contains 66,000 station-years of monthly and annual mean values of sea level from approximately 2250 tide gauge stations around the world received from over 200 national authorities (**Figure 8.2**). Approximately 1500 station-years of data are entered into the database in an average year. Many individual sea level records are linked to those of vertical land movement at the same site obtained by GNSS and stored at SONEL.

The PSMSL data set is the main source of information on sea level variability and change (including 'sea level rise') and is used by many sea level scientists who contribute to research assessments such as those of the Intergovernmental Panel on Climate Change (IPCC). The PSMSL has historically played a major role in the organisation of sea level training courses and provision of training materials.

GNSS at Tide Gauges Data Centre (for GNSS Data)

The Tide GAuge (TIGA) Working Group of the IGS comprises analysis centres as well as a dedicated GNSS at tide gauge data assembly centre (Schöne et al., 2009). This centre is called SONEL (Système d'Observation du Niveau des Eaux Littorales, <http://www.sonel.org>) and is supported by the University of La Rochelle and the French CNRS/INSU institute. SONEL provides information about the status of GNSS stations at or near by tide gauges through a web-based monitoring facility. It assembles, archives, and distributes GNSS observation and metadata that can be accessed through the web-based facility, as well as anonymous File Transfer Protocol (FTP) server.

TIGA and SONEL are working with PSMSL and other centres to provide useful sea-level oriented products from GNSS analyses, and to determine the most appropriate standards and formats for distribution to the sea-level community. An important task is the maintenance of survey records linking the GNSS antenna to the tide gauge benchmark. All tide gauge operators, whether associated with GLOSS or not, are encouraged to have their GNSS data and metadata included in the SONEL data centre.

8.2 Quality Control of Data

Whichever stream of data is considered, the tide gauge data will usually have been sampled at a regular interval. For example, the paper charts of traditional float and stilling well gauges used to be digitised at hourly intervals (or perhaps 30 minutes, rarely more frequently). A modern tide gauge provides data with typically 1 or several minutes sampling. Sometimes the timings of DM data will require correction because of clock drift in the data logger but the sampling will still be regular. Occasionally, a record will have gaps due to gauge malfunction or telemetry drop outs, spikes due to false readings, or datum shifts due to a change in the effective reference zero of the tide gauge.

8.2.1 Real Time Quality Control

In recent years there has been an emphasis on having as many gauges as possible deliver RT or NRT data i.e. typically within an hour. There are several reasons for this. First, if one has RT data, then problems with a gauge can be identified and fixed earlier. Second, the data become

available for many other applications within ‘operational oceanography’. For example, the data can be used within coastal storm surge flood warning services (Pugh and Woodworth, 2014), or can be assimilated into operational deep-ocean circulation models. RT or NRT sea level data can be useful to the navigation of coastal shipping if levels are sent to ships along with meteorological and other information by means of Automatic Identification System Aids to Navigation (AIS AtoN) systems. As several major tsunami events in recent years have demonstrated, sea level data can be important sources of information within tsunami warning systems (Pérez et al., 2013).

These developments led to the establishment of the IOC SLSMF described above. That Facility does not apply a QC to any of the data it receives and does not use the data in any applications; it simply provides a monitoring service. However, there are many national agencies that do have operational systems that require access to RT or NRT data. In these cases, the operational system has to be robust enough not to be perturbed when bad data are recorded (e.g. data spikes). One way to guard against bad data is to have continuous human oversight of the data stream (e.g. as occurs in the UK Storm Tide Forecasting Service for flood warning). However, real time quality control (RTQC) procedures and software have been developed by several groups (e.g. Pouliquen et al., 2011). For example, the Spanish Ports Authority (Puertos del Estado) has developed an automatic QC software package for detection of spikes, gaps, etc. using 1-minute data, before data are displayed to the public and assimilated into a storm surge forecasting system (Pérez et al., 2013). The software provides for tsunami and seiche detection and transmission of alerts to responsible agencies including the national tsunami warning system.

The Integrated Ocean Observing System (IOOS) of NOAA has also produced criteria for quality control of real-time ‘water levels’ (i.e. either sea or lake levels). It proposes a series of 11 tests that operators can incorporate into practices and procedures for QC of their real-time measurements, grouped into required, recommended and strongly recommended tests. IOOS (2014) describes the algorithms for each test, and also provides short reviews of datums and levelling, water level gauges and their applications and their data processing.

Sea level data obtained in real time which require only mild QC to be of interest for certain applications on short timescales (e.g. weeks) are called ‘fast data’, the full QC of DM processing not usually being possible on that

timescale. Sometimes, certain records can stay as ‘fast’ for a while until either the DMQC can be performed or questions about the data or metadata (e.g. concerning datums or timing information) can be answered. As mentioned above, the UHSLC maintains a Fast Data Centre from which data eventually migrate to the UHSLC Research Quality Data Set (RQDS)/JASL.

8.2.2 Delayed Mode Quality Control

The data obtained from tide gauges, either in real time or recovered at intervals of months or years from local data loggers, are usually passed to national Data Assembly Centres (DACs) for delayed mode quality control (DMQC) and archiving. (A list of national centres can be found at http://www.psmsl.org/links/sea_level_contacts/). At this point, the data will be adjusted for Sensor Offset using the metadata discussed in Chapter 4. In turn, these data are often contributed to the international centres described in the previous section, and they will undertake a separate quality control exercise.

The general principles of DMQC that the various centres perform have been described in earlier Volumes of this Manual, in reports and books (e.g. Parker, 2007; Pugh and Woodworth, 2014; Woodworth et al., 2015) and most completely in an unpublished IOC Manual on quality control of sea level observations (IOC, 2014). There are two developments that can be mentioned here, the first particularly relevant to the radar gauges of this Manual and the second to the QC of tide gauge data in general.

8.2.2.1 Using 1-Minute Data within Tide Data QC

Radar gauges can measure sea level every minute, or even faster if required, which is ideal for the measurement of tsunamis, meteotsunamis, seiches and other processes in the ocean that occur on timescales less than an hour. Such higher rate data have not normally been included in the QC performed by most GLOSS-related data centres. Those centres have had a focus on tides, storm surges and mean sea level change, which can be studied adequately with access to hourly sampling (or more ideally 6, 10 or 15 minute values).

IOC (2014) discusses the steps in QC required to ensure good data for those purposes. The main steps involve a ‘tidal analysis’ which yields a separation of the tidal and

non-tidal components of the record (and estimation of 'tidal constants'), with inspection of the non-tidal component (or 'tidal residuals') being especially useful in identifying data problems such as spikes and datum shifts. The tidal component of the record will not be separable more accurately with 1-minute rather than say 15-minute or hourly sampling.

Our advice to data centres or other analysts faced with having to perform a QC on 1-minute data is as follows:

- (1) Ensure that the original 1-minute data are copied safely to an archive so that they can be revisited if necessary. For example, they may be needed for future study of one or more of the higher-rate processes, or they may be required again if QC methods change.
- (2) Radar 1-minute data can be noisy, especially during periods with high waves, so the time series must be inspected (by plotting or with the use of suitable software) so as to reject outliers. For example, this could take the form of rejection of 1-minute measurements that are 3-sigma outliers within a moving half-hour window. However, the particular method used for noisy data rejection (or whether such a method is needed at all) may depend on the location, and must be guided by experiences with radar data such as those described in this Manual.
- (3) If QC is normally performed on hourly values, then a filter can be designed to optimally low-pass the 1-minute values into hourly values. These filters are described in IOC (2014).
- (4) If QC is normally performed by a centre on say 6 or 15 minute average values (a higher rate sampling than hourly usually being required to describe the evolution of storm surges), then we suggest that the 1-minute measurements are averaged. The centre will then already have filters available for subsequent conversion of this normal averaging into hourly, daily etc. values. (Note that different centres use different filters for conversion of hourly values into daily means; this topic has been discussed in Volume 3 and in IOC, 2014).

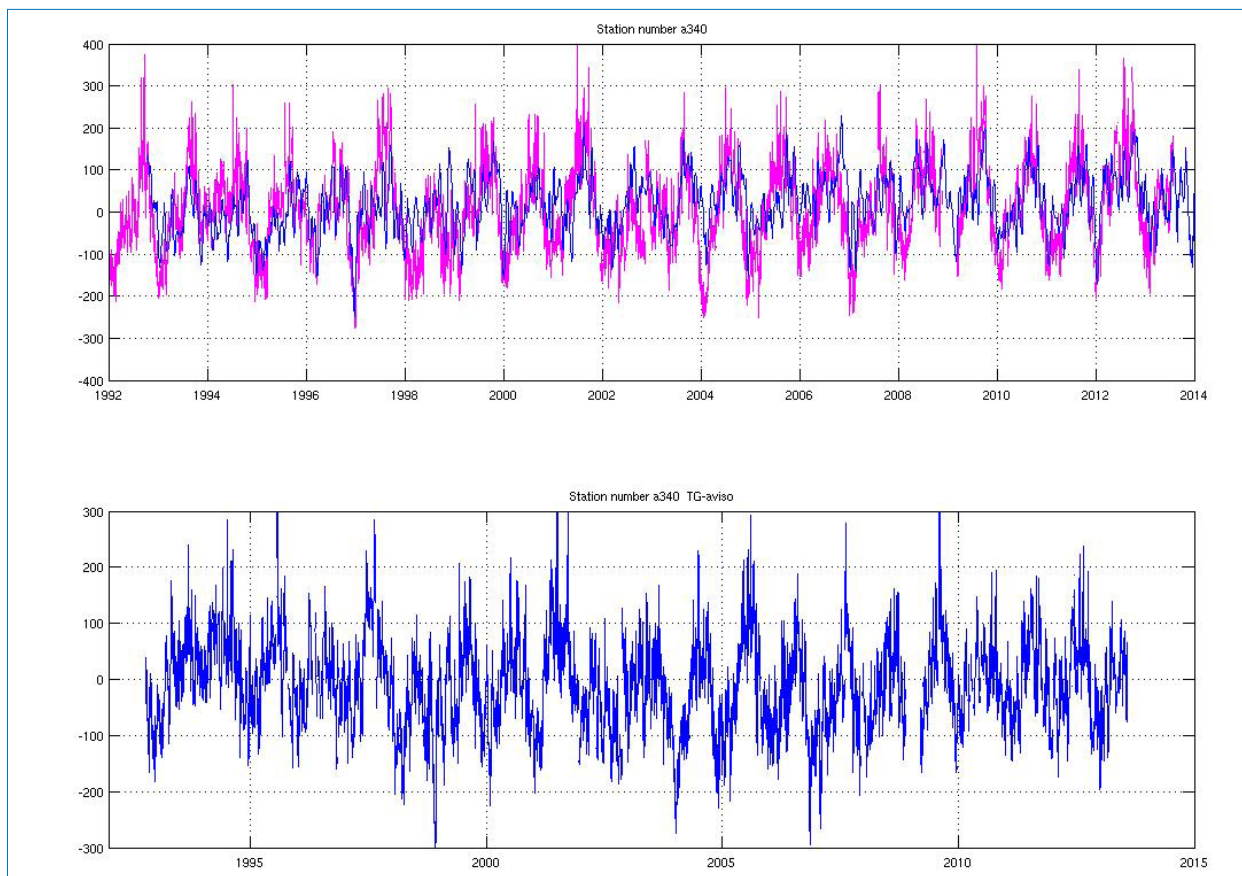

Figure 8.3

(a) The top panel depicts the Kaoshiung tide gauge daily data (pink) and the 10-day altimeter proxy data from AVISO (blue). The mean has been removed from both series. The bottom panel is the difference between the two.

There may sometimes be a need for a special QC to be performed on a short 1-minute data record of perhaps several days or weeks, that contains interesting tsunami or storm surge signals. In that case, we suggest that a QC first be performed on a longer record of perhaps a year, spanning the short period of interest, in which the procedure above has been followed and from which tidal constants have been obtained. The tidal constants can subsequently be used within a tidal prediction program to provide the tidal component at 1-minute sampling for subtraction from the measurements and thereby the clear identification of the short period events. Otherwise, we cannot see within GLOSS the need for, or indeed the possibility of, undertaking a complete QC of all 1-minute data.

8.2.2.2 Using Altimeter Data as a Check of Tide Gauge Datum Stability

An additional aspect to tide gauge QC in recent years has been made possible by the availability of satellite altimeter data. There can be real differences between sea

level variability recorded by a tide gauge at the coast and that measured several 10s of km off-shore by a satellite altimeter, due to the ocean processes which occur between the two points. In addition, there are differences between the two types of sea level (one 'relative' and one 'geocentric') with altimeter data normally adjusted for the inverse barometer effect for periods longer than 20 days and a dynamical correction applied at higher frequencies. Nevertheless, experience in using altimeter data by many scientists over the last two decades has shown that, for most open ocean locations (i.e. islands and open coastlines), there is usually a high degree of correlation between variability in the two types of sea level (e.g. Vinogradov and Ponte, 2011). This correlation enables tide gauge data to be used as a check on the stability of altimeter information (Leuliette et al., 2004) and, conversely, it enables gross errors in tide gauge datum to be identified.

The Joint Archive for Sea Level (JASL) at the University of Hawaii routinely compares daily tide gauge data to the 'proxy' sea level data provided by satellite altimeters (<http://www.aviso.altimetry.fr/en/data/data-access.html>). A comparison plot can serve to assess tide gauge

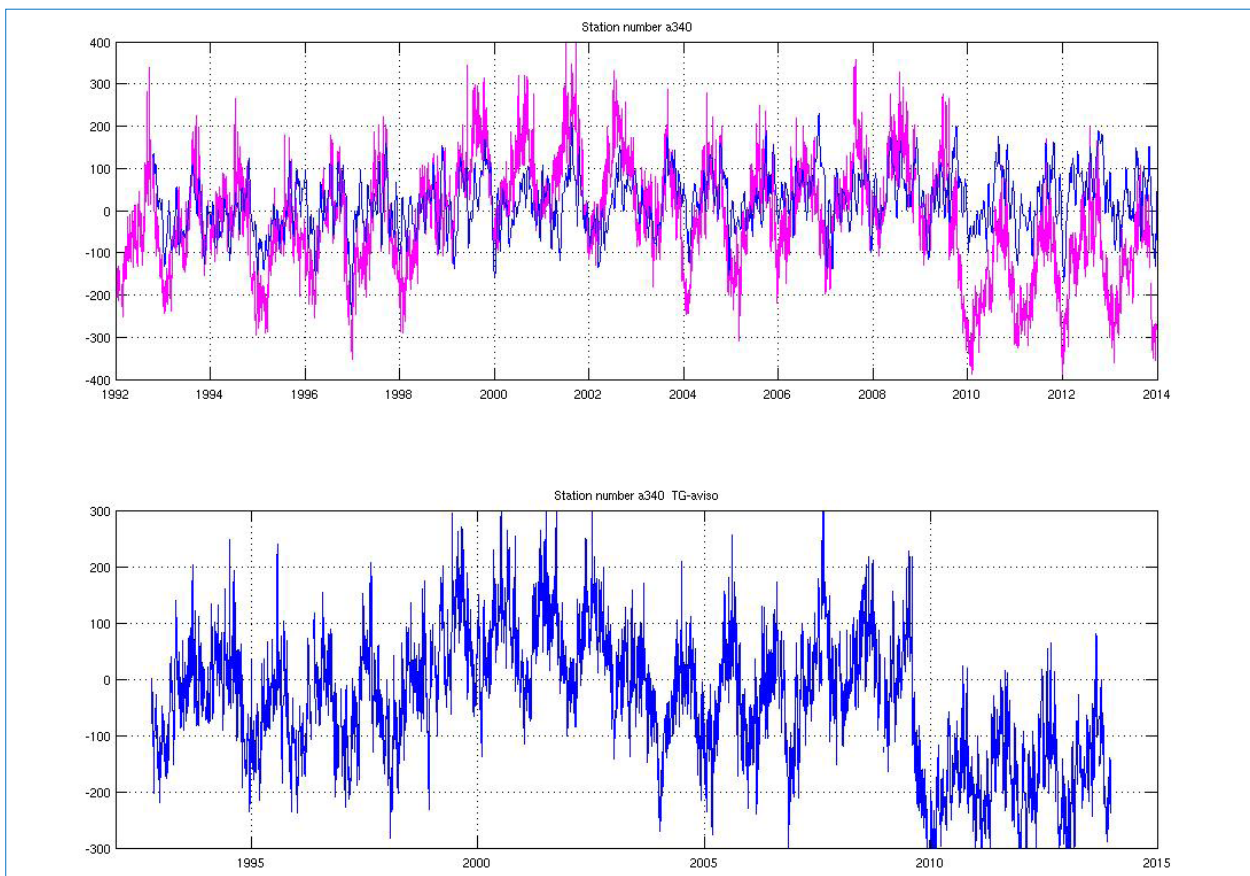

(b) A corrected tide gauge data set was received and confirmed to be now consistent with the altimetry.

reference level stability. As an example, the plot of tide gauge data at Kaohsiung, Taiwan and the corresponding altimeter data showed a clear step function in the difference plot in 2009 (**Figure 8.3(a)**). The data originators at the Central Weather Bureau were contacted and a corrected series was provided (**Figure 8.3(b)**). Similar routine comparisons of monthly means from altimeter and tide gauge data by other groups have identified the occurrence of antenna problems in new radar gauges (Pérez et al., 2014).

8.2.3 Tidal Analysis and QC Packages

National tide gauge agencies that do not have their own QC software, or individual analysts who wish to undertake their own QC, may use one of the packages mentioned below. (Other packages are available but these are the two for which we have most experience.)

- (1) The UHSLC package for processing and quality control of hourly sea level data was assembled and documented by the JASL and has been used extensively by many groups. It has now been updated and made available for 64-bit Windows and Linux operating systems. Its aim is the production of high-quality, scientifically-valid sea level data sets. The software includes the Canadian Institute for Ocean Sciences Tidal Package for tidal analysis and prediction. More information from caldwell@hawaii.edu or <http://ilikai.soest.hawaii.edu/UHSLC/jasl/jaslsoft.html>.
- (2) The Tidal Analysis Software Kit (TASK) from NOC was so far available only as a DOS-based product. The Marine Data Products team has completely rewritten the software to create 'TASK-Windows Edition', a suite of programs to combine accurate harmonic analysis with Windows applications for data manipulation, processing, quality control and graphing of the data. Tools within TASK are intended to make things as simple as possible (e.g. auto flagging of data, gap detection, spike detection, unit conversion, time shifting, sophisticated graphing with easy identification and removal of faulty data, etc.). Included in the package is the POLTIPS-3 tidal prediction software for production of fully-formatted yearly tide tables. More information from dataproduts@noc.ac.uk or <http://noc.ac.uk/using-science/products/tidal-harmonic-analysis>.

8.3 Obligations of Data Providers

It might be thought that all sea level data would pass automatically through a RT-Fast-DM chain of processing, after which high quality data would become available to scientists and others. However, while some data does flow that way, most does not.

The main reason why the chain cannot always be fully automatic is primarily to do with the DMQC. It is only at this point that all the available information on calibration of sensors, levelling of benchmarks for datums etc. are gathered and documented so as to make the final product. Therefore, there has to be continued collaboration between station operators, national DACs and international sea level centres at each point. IOC (2012) makes clear that there are obligations of data providers:

- To ensure that RT data are transmitted to the IOC SLSMF, automatically in this case.
- To make fast data, that has been subjected to partial QC, available by the GLOSS Fast Centre which will then make it available to the wider community within 4-6 weeks. In some cases the Centre will be able to access and make a partial QC of the SLSMF RT data as described above.
- To make DM data, that has been subjected to a full QC, available to one of the DM data centres (BODC or UHSLC) by September following the data-year.
- To make monthly and annual MSL values, together with complete datum information and metadata, available to the PSMSL by September following the data-year.

9. Training Materials and Contacts

The PSMSL maintains web pages (http://www.psmsl.org/train_and_info/) that provide access to training materials developed primarily for GLOSS. These materials include:

- Reading lists of books on tides and sea levels; links to the IPCC Reports; information on geodesy and satellite altimetry and other useful information
- Previous Volumes of this Manual
- Links to sea level contacts in many countries (such contact information becomes out-of-date rapidly and the PSMSL will always be grateful to know of updates via psmsl@noc.ac.uk)
- Tidal analysis software packages (see also Section 8.2.3)

It is also a portal to various products including:

- Sea level trend and anomaly viewers
- Cross-wavelet and wavelet-coherence software
- Information on sea level reconstructions
- Author Archive, containing data sets related to sea level publications that have been archived with the PSMSL
- Information on the PSMSL data coverage and the status of GLOSS

The GLOSS set of web pages (<http://www.gloss-sealevel.org>) provides access to:

- Network status
- The GLOSS Handbook (descriptions of each station in the GLOSS Core Network)
- National and Technical Reports from GLOSS Experts Meetings
- Information on GLOSS training courses
- A guide on where to obtain sea level data

National sea level resources for training and information include those provided by the following countries:

- Australia (Australian Tides Manual, Permanent Committee for Tides and MSL, 2004)
- France (<http://refmar.shom.fr> and <http://www.sonel.org>)
- USA, NOAA (<http://tidesandcurrents.noaa.gov/>)
- USA, the COMET programme at the University of Colorado (<https://www.meted.ucar.edu>) contains a considerable amount of training material for the geoscience community including the use of GNSS, surveying, hydrography, storm surges and planning for sea level rise

There are also sea level information materials and software packages produced by others which will be of interest to GLOSS. These include:

- A list of recent sea level publications maintained by the University of Colorado (<http://sealevel.colorado.edu/>)
- The T-Tide tidal analysis package (<http://www.eos.ubc.ca/~rich/>) that, like the University of Hawaii package referred to in Section 8.2.3, is based on the IOS Canada Tidal Package
- The altimetry data centres in http://www.psmsl.org/train_and_info/training/reading/ provide their own aspects of training

Any of the named contributors to this Manual or listed as authors of papers in Supplement would be happy to share their expertise on aspects of sea level monitoring. A list of people in each country with experience either of radar gauges or radar gauge data is given in **Table 9.1(a)**; more contact details can be found in IHO (2015). People with experience of satellite transmission methods together with tide gauges, and who also may be contacted for advice, are mentioned in **Table 9.1(b)**. (These lists are obviously not exclusive ones.) General advice on GLOSS can be obtained from the GLOSS Technical Secretary (t.aarup@unesco.org).

Table 9.1

(a) Radar Gauge Contacts in Each Country

This table includes countries and agencies shown as having radar gauges in IHO (2015) or represented by the contributors to this Manual. In most cases a contact name and email is given. The last column refers to the gauge manufacturer that we understand is most used by that agency/country as of April 2016.

Australia	Bill Mitchell, Bureau of Meteorology	b.mitchell@bom.gov.au	V
	John Broadbent, Maritime Safety Queensland	tides@msq.qld.gov.au	V
Bahrain	Rashid Abdulla Al Suwaidi, Survey&Land Reg.	rasid.alsuwaidi@slrb.gov.bh	O
Brazil	Luiz Nonnato, Univ. São Paulo	luiz.nonnato@usp.br	O
Chile	Juan Fierro and Jorge Gaeta, SHOA	oceanografia@shoa.cl	V
Denmark	Lonny Hansen, DMI	lha@dm.dk	EH
France	Gael André, SHOM	gael.andre@shom.fr	K
	Guy Wöppelmann, Univ. La Rochelle	guy.woppelmann@univ-lr.fr	
	Laurent Testut, LEGOS, Toulouse	laurent.testut@legos.obs-mip.fr	
Germany	Tilo Schöne, GFZ	tschoene@gfz-potsdam.de	O
	Stephan Mai, BAFG	mai@bafg.de	
	Gunter Liebsch, BKG	gunter.liebsch@bkg.bund.de	V
India	Prakash Mehra, NIO	pmehra@nio.org	
	Srinivas Kumar, INCOIS	srinivas@incois.gov.in	
Israel	Israel Oceanographic and Limnological Research		M
Italy	Giovanni Arena, ISPRA	giovanni.arena@isprambiente.it	O
Japan	Hironori Hayashibara, JMA	tide@climar.kishou.gov.jp	T
Netherlands	Koos Doekes, Rijkswaterstaat	koos.doekes@rws.nl	Ra
New Zealand	Glen Rowe, LINZ	growe@linz.govt.nz	
Norway	Tor Torresen	tor.torresen@statkart.no	M
Oman	Dr. Juma, Directorate General of Meteorology	j.almaskari@met.gov.om	S
Peru	Directorate of Hydrography and Navigation	dihidronav@dhn.mil.pe	G,V
Philippines	Hydrography, NMRIA		
South Africa	Ruth Farre, SANHO	hydrosan@iafrica.com	O
Spain	Begoña Pérez Gómez, Puertos del Estado	bego@puertos.es	M
	Elena Tel, Inst. Español de Oceanografía	elena.tel@md.ieo.es	V
	Bernat Puyol, Instituto Geográfico Nacional	bpuyol@fomento.es	V
United Kingdom	Jeff Pugh, National Oceanography Centre	jpugh@noc.ac.uk	O,V,W
	Travis Mason, Channel Coast Observatory	travis.mason@noc.soton.ac.uk	R
USA	Robert Heitsenrether, NOAA	robert.heitsenrether@noaa.gov	W
	Mark Merrifield, UHSLC	markm@soest.hawaii.edu	V,S

EH = Endress and Hauser, G = GEONICA, K = Krohne, M = MIROS, O = OTT, R = Rosemount,
 Ra = Radac, S = Sutron, T = Tokyo Keikei, V = VEGAPULS, W = Waterlog.

(b) People with Experience of Satellite Data Transmission Methods together with Tide Gauges

ARGOS	Laurent Testut, France	laurent.testut@legos.obs-mip.fr
GOES/METEOSAT/MTSAT	Tilo Schöne, Germany	tschoene@gfz-potsdam.de
	Peter Foden, UK	prf@noc.ac.uk
	Jeff Pugh, UK	jpugh@noc.ac.uk
	Robert Heitsenrether, USA	robert.heitsenrether@noaa.gov
INMARSAT BGAN	Mark Merrifield, USA	markm@soest.hawaii.edu
	Juan Fierro and Jorge Gaeta, Chile	oceanografia@shoa.cl
	Tilo Schöne, Germany	tschoene@gfz-potsdam.de
IRIDIUM	Robert Heitsenrether, USA	robert.heitsenrether@noaa.gov
VSAT	Tilo Schöne, Germany	tschoene@gfz-potsdam.de
	Prakash Mehra, India	pmehra@nio.org

References

References shown in *Italic* are not mentioned explicitly in the text and are included to provide information on previous research with radar tide gauges.

- Altamimi, Z., Collilieux, X. and Métivier, L. 2011. ITRF2008: an improved solution of the International Terrestrial Reference Frame, *Journal of Geodesy*, 85, 457–473, doi:10.1007/s00190-011-0444-4.
- Bevis, M., Scherer, W. and Merrifield, M. 2002. Technical issues and recommendations related to the installation of continuous GPS Stations at tide gauges. *Marine Geodesy*, 25, 87-99, doi:10.1080/014904102753516750.
- Blasi, C.J. 2009. A new technology for the measurement of the sea level and the sea state. Environmental Geology, 57, 331–336, doi:10.1007/s00254-008-1632-2.*
- Blasi, C., Mai, S., Wilhelmi, J., Zenz, T. and Barjenbruch, U. 2014. A powerful method of measuring sea wave spectra and their direction. Pp.913-920 in, *Proceedings of the 11th International Conference on Hydrosience and Engineering*, 28 September – 2 October 2014, Hamburg (eds. Lehfeldt, R. and Kopmanns, R.), ISBN 978-3-939230-32-8.
- Blewitt, G., Kreemer, C., Hammond, W.C., Plag, H-P., Stein, S. and Okal, E. 2006. Rapid determination of earthquake magnitude using GPS for tsunami warning systems. *Geophysical Research Letters*, 33, L11309, doi:10.1029/2006GL026145.
- BOM, 2006. A brief description of the CREX sea level bulletins to be issued by the Australian Bureau of Meteorology on GTS with effect from 18 December 2006. Report of the Australian Bureau of Meteorology. Available from https://www.wmo.int/pages/prog/www/ois/Operational_Information/Newsletters/2000_2009/2008/Jan08/CREXbulletinsBOM.pdf.
- Boon, J.D., Heitsenrether, R.M. and Bushnell, M. 2009. Microwave-acoustic water level sensor comparisons: sensor response to change in oceanographic and meteorological parameters. Proceedings of the MTS/IEEE OCEANS 2009 Conference, Biloxi, 26-29 October 2009, pp.1-10.*
- Boon, J.D., Heitsenrether, R.M. and Hensley, W.M. 2012. Multi-sensor evaluation of microwave water level error. *Proceedings of Oceans '12, Hampton Roads, Virginia, MTS/IEEE*, 8pp., doi:10.1109/OCEANS.2012.6405079.
- Boon, J.D. 2013. Microwave water level measurement error. A reanalysis of 2011 multi-sensor data. U.S. Army Field Research Facility, Duck, North Carolina. Internal Report. 23pp.
- Boon, J.D. 2014. Reducing wave-induced microwave water-level measurement error with a least squares-designed digital filter. *Journal of Atmospheric and Oceanic Technology*, 31, 481-502, doi:10.1175/JTECH-D-13-00160.1.
- Broadbent, G.J. 2005. Experience with radar sensor equipped tide gauges in Queensland. Proceedings of the ATON (Aids TO Navigation) Conference, Canberra, Australia, March 2005.*
- Brooks, B.A., Merrifield, M.A., Foster, J., Werner, C.L., Gomez, F., Bevis, M. and Gill, S. 2007. Space geodetic determination of spatial variability in relative sea level change, Los Angeles basin. *Geophysical Research Letters*, 34, L01611, doi:10.1029/2006GL028171.
- Brumbi, D. 2003. *Fundamentals of radar technology for level gauging*. 4th Edition. Duisberg: KROHNE Messtechnik GmbH & Co.
- Brumbi, D. and Van Zyl, I. 2009. Modern technologies for level measurement. Paper A4.2 (pp.97-102) in *Proceedings of the SENSOR+TEST Conference, Volume I, 26-28 May 2009, Nürnberg, Germany.*

- Burns, S.D. 2009. The METEOSAT data collection system. Proceedings of the 2009 EUMETSAT Meteorological Satellites Conference, Bath, UK, 21-25 September 2009. Available from <http://www.eumetsat.int>.
- Church, J.A., Clark, P.U. Cazenave, A., Gregory, J.M., Jevrejeva, S., Levermann, A., Merrifield, M.A., Milne, G.A., Nerem, R.S., Nunn, P.D., Payne, A.J., Pfeffer, W.T., Stammer, D. and Unnikrishnan, A.S. 2013. Sea Level Change. In: Stocker, T.F., Qin, G.-K. Plattner, M. Tignor, S.K. Allen, J. Boschung, A. Nauels, Y. Xia, V. Bex and P.M. Midgley (eds.), *Climate Change 2013: The Physical Science Basis. Contribution of Working Group I to the Fifth Assessment Report of the Intergovernmental Panel on Climate Change*. Cambridge University Press, Cambridge, United Kingdom and New York, NY, USA.
- Devine, P. 2000. Radar level measurement – The users guide. Published by VEGA Controls Ltd., UK. ISBN 0-9538920-0-X. 154pp.
- Eberlein, L. and Liebsch, G. 2003. Experiences with the Vega radar gauge on a buoy. Proceedings of the GLOSS Experts Meeting No.8, Workshop on New Technical Developments in Sea and Land Level Observing Systems, Tuesday-Thursday October 14-16 2003, IOC, UNESCO, 1 Rue Miollis, Paris. Available from http://www.gloss-sealevel.org/technical_forum/documents/lutzeberlein.pdf.
- EUMETSAT. 2013. TD 16 - Meteosat data collection and distribution service. Darmstadt: Germany. 63pp. Available from <http://www.eumetsat.int/website/home/Data/MeteosatServices/MeteosatDataCollectionServices/index.html>.
- Ewans, K., Feld, G. and Jonathan, P. 2014. On wave radar measurement. *Ocean Dynamics*, 64, 1281–1303, doi:10.1007/s10236-014-0742-5.
- Forbes, S., MacAulay, P., Coolen, C. and Carmichael, F. 2009. A laser-based water level sensor and robust insulated and heated multi-well stilling well system for ice-prone temperate and sub-arctic environments. Presentation at U.S. Hydro 2009, 11-14 May 2009, Norfolk, Virginia. Available from <http://ushydro.thsoa.org/us09papers.htm>.
- Fulford, J.M., Ester, L.W. and Heaton, J.W. 2007. Accuracy of radar water level measurements. US Geological Survey report. United States Committee for Irrigation and Drainage (SCID), 4th International Conference on Irrigation and Drainage, Sacramento, California. Available from <http://www.waterlog.com/media/pdfs/usgs-study-small.pdf>.
- Hannsen, R.F. 2001. Radar interferometry: data interpretation and error analysis. The Netherlands: Kluwer Academic Publishers. 308pp.
- Heitsenrether, R.M., Bushnell, M.H. and Boon, J.D. 2008. *Understanding the impact of surface waves on microwave water level measurements. MTR/IEEE Oceans 2008 Conference and Exhibition, Québec City, Canada, 15-18 September 2008. 9pp.*
- Heitsenrether, R.M. 2010. Using microwave radar for long term remote sensing of ocean surface dynamics. Proceedings of the 17th Conference on Atmospheric and Oceanic Fluid Dynamics, 8-12 June 2009, Stowe, Vermont. American Meteorological Society. Available from <http://ams.confex.com/ams/pdfpapers/154150.pdf>.
- Heitsenrether, R. and Davis, E. 2011. Test and evaluation report. Limited acceptance of the Design Analysis WaterLog H-3611i microwave radar water level sensor. NOAA Technical Report NOS CO-OPS 061. Available from http://tidesandcurrents.noaa.gov/publications/Technical_Report_NOS_CO-OPS_061.pdf.
- Heitsenrether, R.M., Hensley, W.M. and Boon, J.D. 2011. *Results from NOAA's test and evaluation of microwave radar water level sensors and plans for a transition to operational applications. Proceedings of the MTS/IEEE Oceans'11 Conference, 19-22 September 2011, Kona, Hawaii.*
- Heitsenrether, R., Hensley, W. and Krug, W. 2012. Measurement requirements for radar water level sensor laboratory verification tests. NOAA Internal Report. 8pp.
- Holgate, S., Foden, P., Pugh, J. and Woodworth, P. 2008. Real time sea level data transmission from tide gauges for tsunami monitoring and long term sea level rise observations. *Journal of Operational Oceanography*, 1, 3-8, doi:10.1080/1755876X.2008.11081883.

- Holgate, S.J., Matthews, A., Woodworth, P.L., Rickards, L.J., Tamisiea, M.E., Bradshaw, E., Foden, P.R., Gordon, K.M., Jevrejeva, S. and Pugh, J. 2013. New data systems and products at the Permanent Service for Mean Sea Level. *Journal of Coastal Research*, 29, 493-504, doi:10.2112/JCOASTRES-D-12-00175.1.
- IHO, 2015. Inventory of Tide Gauges in Member States (October 2015). A compilation of tide gauges and their operators by the International Hydrographic Organization. Available from http://www.iho.int/mtg_docs/com_wg/IHOTC/IHOTC_Misc/TideGaugeInventory.pdf.
- Illigner, J., Sofian, I., Abidin, H., Arief Syafi'i, M., Schöne, T. (2016): Coastal Sea Level Monitoring in Indonesia – Connecting the Tide Gauge Zero to Leveling Benchmarks. - In: Rizos, C., Willis, P. (Eds.), *IAG 150 Years: Proceedings of the IAG Scientific Assembly in Postdam, Germany, 2013*, (International Association of Geodesy Symposia; 143), Cham : Springer International Publishing, p. 451-457. http://doi.org/Doi:10.1007/1345_2015_23
- IOC, 2006. Manual on sea-level measurement and interpretation. Volume 4: An Update to 2006. (eds. T. Aarup, M. Merrifield, B. Pérez, I. Vassie and P. Woodworth). Intergovernmental Oceanographic Commission Manuals and Guides No. 14. Paris: UNESCO/Intergovernmental Oceanographic Commission.
- IOC, 2011. Working group on tsunamis and other hazards related to sea-level warning and mitigation systems (TOWS-WG). Inter-ICG Task Team 1 on Sea Level Monitoring for Tsunami. Available from <http://unesdoc.unesco.org/images/0019/001939/193911e.pdf>.
- IOC, 2012. The Global Sea Level Observing System (GLOSS) Implementation Plan – 2012. UNESCO/Intergovernmental Oceanographic Commission. 37pp. (IOC Technical Series No. 100). Available from <http://ioc.unesco.org>.
- IOC, 2014. Manual on quality control of sea level observations (eds. M.J. Garcia et al.), in press. UNESCO/Intergovernmental Oceanographic Commission: Paris.
- IOOS, 2014. Manual for real-time quality control of water level data. A guide to quality control and quality assurance for water level observations (eds. Bushnell, M. et al.). Version 1.0. Integrated Ocean Observing System (IOOS) report. Available from <http://www.ioos.noaa.gov/qartod/>.
- Irish, J.L., Wozencraft, J.M., Cunningham, A.G. and Giroud, C. 2006. Nonintrusive measurement of ocean waves: Lidar wave gauge. *Journal of Atmospheric and Oceanic Technology*, 23, 1559-1572, doi:10.1175/JTECH1936.1.
- Larson, K. M., Löfgren, J. and Haas, R. 2013. Coastal sea level measurements using a single geodetic GPS receiver. *Advances in Space Research*, 51(8), 1301–1310, doi:10.1016/j.asr.2012.04.017.
- Leigh, G.E. 2009 (date uncertain). Bottles, pots and pans? – Marking the surveys of the U.S. Coast & Geodetic Survey and NOAA. National Oceanic and Atmospheric Administration report. Available from http://www.ngs.noaa.gov/web/about_ngs/history/indexhUSCGS.shtml [accessed November 2011].
- Leuliette, E.W., Nerem, R.S. and Mitchum, G.T. 2004. Calibration of TOPEX/Poseidon and Jason altimeter data to construct a continuous record of mean sea level change. *Marine Geodesy*, 27, 79-94, doi:10.1080/01490410490465193.
- Mai, S. and Zimmermann, C. 2000. Applicability of radar level gauges in wave monitoring. *Proceedings of the 2nd International Conference on Port Development and Coastal Environment*, Varna, Bulgaria, 2000.
- Martín Míguez, B., Pérez Gómez, B. and Álvarez Fanjul, E. 2005. The ESEAS-RI sea level test station: Reliability and accuracy of different tide gauges. *International Hydrographic Review*, 6, 1. 2–11.
- .Martín Míguez, B., Le Roy, R. and Wöppelmann, G. 2008a. The use of radar tide gauges to measure variations in sea level along the French coast. *Journal of Coastal Research*, 24, 61-68, doi:10.2112/06-0787.
- Martín Míguez, B., Testut, L. and Wöppelmann, G. 2008b. The Van de Castele test revisited: an efficient approach to tide gauge error characterization. *Journal of Atmospheric and Oceanic Technology*, 25, 1238-1244, doi:10.1175/2007JTECHO554.1

- Martín Míguez, B., Testut, L. and Wöppelmann, G. 2012. Performance of modern tide gauges: towards mm-level accuracy. *Advances in Spanish Physical Oceanography (Scientia Marina)*, 76 S1, 221-228, doi:10.3989/scimar.03618.18A.
- Matthäus, W. 1972. On the history of recording tide gauges. *Proceedings of the Royal Society of Edinburgh*, B, 73, 26-34, doi:10.1017/S0080455X00002083.
- Mazzotti, S., Lambert, A., Henton, J., James, T.S. and Courtier, N. 2011. Absolute gravity calibration of GPS velocities and glacial isostatic adjustment in mid-continent North America. *Geophysical Research Letters*, 38, L24311, doi:10.1029/2011GL049846.
- Mehra, P., Prabhudesai, R.G., Joseph, A., Vijaykumar, Agarvadekar, Y., Luis, R., Damodaran, S. and Viegas, B. 2009. A one year comparison of radar and pressure tide gauge at Goa, West Coast of India. *Proceedings of the International Symposium on Ocean Electronics (SYMPOL)*, Cochin, 18-20 November 2009 (eds. Pillai, P.R.S. and Supriya, M.H.), 173-183.
- Mehra, P., Agarvadekar, Y., Vijaykumar, Luis, R. and Nadaf, L. 2012. Comparison of sea-level measurements using microwave radar and subsurface pressure gauge deployed in Mandovi estuary in Goa, Central West Coast of India. In, *Ocean Sensing and Monitoring* (eds. Hou, W.W. and Amone, R.). *Proceedings of the Society of Photo-Optical Instrumentation Engineers*, Vol.8372, 7pp. Available from <http://drs.nio.org/drs/handle/2264/4081>.
- Meldrum, D. 2013. A brief analysis of the evolution of the Satellite Communications market with regard to various classes of in situ low-power marine environmental observation platform. Report to the Joint Technical Commission for Oceanography and Marine Meteorology, Observations Coordination Group. Washington, D.C., September 2013.
- Mitchum, G.T. 2000. An improved calibration of satellite altimetric heights using tide gauge sea levels with adjustment for land motion. *Marine Geodesy*, 23, 145-166, doi:10.1080/01490410050128591.
- Moray, R. 1665-66. Considerations and enquiries concerning tides, by Sir Robert Moray; Likewise for a further search into Dr. Wallis's newly publish't hypothesis. *Philosophical Transactions of the Royal Society*, 1, 298-301, doi:10.1098/rstl.1665.0113.
- National Resources Canada (NRC), 2015. <http://www.nrcan.gc.ca/earth-sciences/geomatics/geodetic-reference-systems/tools-applications/10925#ppp>.
- NOAA, 2013a. Field installation guide. Field installation procedures for Design Analysis WaterLog® H3611i Microwave Radar Water Level Sensor using the Sutron Data Collection Platform. Version 1.0. January 2013. Washington, D.C.: National Oceanic and Atmospheric Administration, U.S. Department of Commerce, National Ocean Service Center for Operational Oceanographic Products and Services. 65pp.
- NOAA, 2013b. A guide to CO-OPS SHEF and CREX products. NOAA Technical Report NOS CO-OPS 026. Revised 2013. Available from http://www.co-ops.nos.noaa.gov/publications/NOAA_Technical_Report_NOS_COOPS_026.pdf.
- NOAA, 2015. NOAA guidance document for determination of vertical land motion at water level stations using GPS technology. NOAA Technical Report NOS 139. 18pp. Available from https://tidesandcurrents.noaa.gov/publications/NOS_Tech_report_139.pdf.
- Park, J., Heitsenrether, R. and Sweet, W. 2014. Water level and wave height estimates at NOAA tide stations from acoustic and microwave sensors. *Journal of Atmospheric and Oceanic Technology*, 31, 2294-2308, doi:10.1175/JTECH-D-14-00021.1.
- Parker, B.B. 2007. Tidal Analysis and Prediction. NOAA Special Publication NOS CO-OPS 3. Available from <http://tidesandcurrents.noaa.gov>.
- PCTMSL, 2004. Australian Tides Manual. Permanent Committee on Tides and Mean Sea Level (PCTMSL). Special Publication No. 9, Version 4.3. 69pp. Available from <http://www.icsm.gov.au/tides/>.
- Pérez, B., Alvarez-Fanjul, E., Pérez, S., de Alfonso, M. and Vela, J. 2013. Use of tide gauge data in operational oceanography and sea level hazard warning systems. *Journal of Operational Oceanography*, 6, 1-18.
- Pérez, B., Payo, A., López, D., Woodworth, P. and Alvarez-Fanjul, E. 2014. Overlapping sea level time series measured using different technologies: an example from the REDMAR Spanish Network. *Natural Hazards and Earth System Sciences*, 14, 589-610, doi:10.5194/nhess-14-589-2014.

- Pérez Gómez, B. 2014. Design and implementation of an operational sea level monitoring and forecasting system for the Spanish coast. PhD Thesis, University of Cantabria.
- Poffa, N. (ed.) 2014. Guidelines for sea level data transmissions through GTS in the frame of coastal hazard warning systems. V 1.0, November 2014. Available from the Measuring and Instrumentation Department of SHOM, France. <http://refmar.shom.fr/documents/10227/106226/Guidelines-for-sea-level-data-transmissions-GTS-coastal-warning-systems.pdf>.
- Pouliquen, S. and others. 2011. Recommendations for in-situ data Real Time Quality Control. EuroGOOS Publication No. 27. EuroGOOS, Norrköping, Sweden. 23pp. Available from <http://eurogoos.eu/increasing-eurogoos-awareness/publications/>.
- Prior-Jones, M. 2011. Satellite communications systems buyers' guide. Internal Report. British Antarctic Survey, Cambridge.
- Pugh, D.T. and Woodworth, P.L. 2014. Sea-level science: Understanding tides, surges, tsunamis and mean sea-level changes. Cambridge: Cambridge University Press. ISBN 9781107028197. 408pp.
- Quarty, G.D., Guymer, T.H. and Srokosz, M.A. 1996. The effects of rain on Topex radar altimeter data. *Journal of Atmospheric and Oceanic Technology*, 13, 1209-1229, doi:10.1175/1520-0426(1996)013<1209:TEOROT>2.0.CO;2.
- Ray, R.D., Beckley, B.D. and Lemoine, F.G. 2010. Vertical crustal motion derived from satellite altimetry and tide gauges, and comparisons with DORIS measurements. *Advances in Space Research*, 45, 1510–1522, doi:10.1016/j.asr.2010.02.020.
- Riley, K. and Jethra, R. 2012. Use guided-wave radar to measure water level in steam loops. *CEP Magazine*, American Institute of Chemical Engineers, December 2012, 22-26.
- Rütten, S., Mai, S., Wilhelmi, J., Zenz, T., Winkelbauer, J., Fröhle, P. and Barjenbruch, U. 2013. *Comparison of directional spectra of sea waves estimated by an array of radar sensors and a directional waverider buoy. Proceedings of 6th SCACR International Short Conference on Applied Coastal Research, Lisbon, Portugal.*
- Santamaría-Gómez, A., Gravelle, M., Collilieux, X., Guichard, M., Míguez, B.M., Tiphaneau, P. and Wöppelmann, G. 2012. Mitigating the effects of vertical land motion in tide gauge records using a state-of-the-art GPS velocity field. *Global and Planetary Change*, 98-99, 6-17, doi:10.1016/j.gloplacha.2012.07.007.
- Santamaría-Gómez, A., Watson, C., Gravelle, M., King, M. and Wöppelmann, G. 2015. Levelling co-located GNSS and tide gauge stations using GNSS reflectometry. *Journal of Geodesy*, 89, 241-258, doi:10.1007/s00190-014-0784-y.
- Santamaría-Gómez, A. and Watson, C. 2016. Remote leveling of tide gauges using GNSS reflectometry: case study at Spring Bay, Australia. *GPS Solutions*, doi:10.1007/s10291-016-0537-x.
- Schöne, T., Schön, N. and Thaller, D. 2009. IGS tide gauge benchmark monitoring pilot project (TIGA): Scientific benefits. *Journal of Geodesy*, 83, 249-261, doi:10.1007/s00190-008-0269-y.
- Shirman, B. 2003. Comparison of a radar and float gauge at Haifa. *Proceedings of the GLOSS Experts Meeting No.8, Workshop on New Technical Developments in Sea and Land Level Observing Systems, Tuesday-Thursday October 14-16 2003, IOC, UNESCO, 1 Rue Miollis, Paris.* Available from <http://www.gloss-sealevel.org/>.
- Teferle, F.N., Bingley, R.M., Orliac, E.J., Williams, S.D.P., Woodworth, P.L., McLaughlin, D., Baker, T.F., Shennan, I., Milne, G.A., Bradley, S.L. and Hansen, D. 2009. Crustal motions in Great Britain: evidence from continuous GPS, Absolute Gravity and Holocene sea-level data. *Geophysical Journal International*, 178(1), 23-46, doi:10.1111/j.1365-246X.2009.04185.x.
- Testut, L., Martín Míguez, B., Wöppelmann, G., Tiphaneau, P., Pouvreau, N. and Karpytchev, M. 2010. Sea level at Saint Paul Island, southern Indian Ocean, from 1874 to the present. *Journal of Geophysical Research*, 115, C12028, doi:10.1029/2010JC006404.
- Vassie, J.M., Woodworth, P.L. and Holt, M.W. 2004. An example of North Atlantic deep ocean swell impacting Ascension and St. Helena islands in the central South Atlantic. *Journal of Atmospheric and Oceanic Technology*, 21(7), 1095-1103, doi:10.1175/1520-0426(2004)021<1095:AEONAD>2.0.CO;2.

- Vinogradov, S. V. and Ponte, R. M. 2011. Low frequency variability in coastal sea level from tide gauges and altimetry. *Journal of Geophysical Research*, 116, C07006, doi:10.1029/2011JC007034.
- Warne, J. and Brewster, A. 2014. Australian Tsunami Warning Sea Level Observation System: ASLOS Siting Specification. Bureau of Meteorology, Report ASLOS-NMD-004.
- Washburn, S.A., Haines, B.J., Born, G.H. and Fowler, C. 2011. The Harvest Experiment LIDAR system: water level measurement device comparison for Jason-1 and Jason-2/OSTM calibration. *Marine Geodesy*, 34, 277-290, doi:10.1080/01490419.2011.590114.
- Wikipedia, 2015a. <http://en.wikipedia.org/wiki/FMCW>.
- Wikipedia, 2015b. http://en.wikipedia.org/wiki/Extremely_high_frequency.
- WMO, 2010. Manual on Stream Gauging. Volume I – Fieldwork. World Meteorological Organization Report WMO-No. 1044. 254pp.
- Wöppelmann, G. and Marcos, M. 2016. Vertical land motion as a key to understanding sea level change and variability. *Reviews of Geophysics*, 54, doi:10.1002/2015RG000502.
- Woodworth, P.L., Vassie, J.M., Spencer, R. and Smith, D.E. 1996. Precise datum control for pressure tide gauges. *Marine Geodesy*, 19(1), 1-20.
- Woodworth, P.L. and Smith, D.E. 2003. A one year comparison of radar and bubbler tide gauges at Liverpool. *International Hydrographic Review*, 4(3), 42-49.
- Woodworth, P. L., Hughes, C. W., Bingham, R. J. and Gruber, T. 2012. Towards worldwide height system unification using ocean information. *Journal of Geodetic Science*, 2(4), 302–318, doi:10.2478/v10156-012-004-8.
- Woodworth, P.L., Pugh, D.T. and Plater, A.J. 2015. Sea-level measurements from tide gauges. Chapter 35 (pp.557-574) in, *Handbook of Sea-Level Research*, First Edition. Edited by Ian Shennan, Antony J. Long, and Benjamin P. Horton. Published 2015 by John Wiley & Sons, Ltd.

Appendix 1:

Radar Gauges from Major Manufacturers as of April 2016

Tide Gauge	Radar Type	Radar Frequency	Beam Angle Full-Width	Typical Accuracy	Measurement Time	Power Consumption	Output	Web Information	Notes
OTT Kalesto	FMCW	24.125 GHz	10 deg	1 cm	17 sec for 40 measurements that are then averaged	500 mA at 12V DC in Active mode	RS485	N/R	1
VEGAPULS 61	Pulse	26 GHz	10 deg	2 mm	measuring cycle ~450 msec	22 mA maximum at 12V DC	4-20 mA Current Loop/HART	www.vega.com	2
Waterlog H-3611	Pulse	~26 GHz	10 deg	3 mm	typical measuring cycle 420 msec	12 mA at 12V DC typically in Active mode	SDI-12	www.waterlog.com	
OTT RLS	Pulse	24 GHz	12 deg	3 mm	16 Hz raw rate, averaged to 20 sec	12 mA at 12V DC in Active mode	SDI-12 and RS485	www.ott.com	
Campbell Scientific CS475-477	Pulse	~26 GHz	10 deg (for CS475 and 476) or 8 deg (for CS477)	5 mm	N/M	14 mA at 12V DC typically	SDI-12	www.campbellsci.com	3
Endress and Hauser FMR245 (successor FMR52)	Pulse	26GHz	10 deg (with 3 inch antenna)	2 mm	N/M	N/M	4-20 mA Current Loop/ HART	www.uk.endress.com	
GEONICA DATAMAR 2000C/3000C	Pulse	26GHz	8 deg	1 mm	1 sec	10 mA at 12V DC	SDI-12	www.geonica.com	
Valeport VRS-20	Pulse	25GHz	12 deg	10 mm	8 Hz raw rate, averaged to 10-360 secs	35 mA at 12V DC	RS-232/485 and SDI-12	www.valeport.co.uk	
Sutron RLR-003	Pulse	6.2 GHz	32 deg	3 mm	10 Hz	<36 mA at 12V DC Active mode	SDI-12	www.sutron.com	
Tokyo Keiki MRG-10	Pulse	5.8 GHz	17 deg	10 mm	1 Hz	Operates at 16-36V	RS-422A or 4-20 mA Current Loop/HART	www.tokyo-keiki.co.jp	

Tide Gauge	Radar Type	Radar Frequency	Beam Angle Full-Width	Typical Accuracy	Measurement Time	Power Consumption	Output	Web Information	Notes
Krohne BM70	FMCW	10 GHz	12 deg	5 mm	1 Hz	~10 W at 24V DC	4-20 mA Current Loop/HART (digital)	http://krohne.com/	4
Krohne Optiwave 7300C	FMCW	24-26 GHz	8 deg	3 mm	1 Hz	25 mA at 12V DC (less for digital output)	4-20 mA Current Loop/HART (digital)	http://krohne.com/	4
Miros Rangefinder SM-094/2	FM Chirp	9.4-9.8 GHz triangular modulation	5 deg (narrow beam) or 10 deg (wide beam)	1 cm individual measurements, 1 mm averaged	20-60,000 msec or 'polling mode' for wave measurement	< 500 mA at 24V DC (10W)	RS422	www.miros.no	5
Radac WaveGuide Radar	FMCW	9.8-10.3 GHz triangular modulation	10 deg	1 cm	1 sec	24-64 VDC / 100-240VAC/ 6 Watt	RS232	http://radac.nl/	6
Rosemount (formerly SAAB) Waveradar Rex Tide/Wave Gauge	FMCW	9.7-10.3 GHz triangular modulation	10 deg	6 mm	10 Hz	<650 mA at 24V DC in operating mode	RS232 or Analogue	www.rsaqua.co.uk	
Krohne BM100	Pulse	2 GHz	guided-wave radar (~60 cm diameter stilling well required)	3mm if range < 6m, 3mm + 0.02 % of range if range > 6m	1 Hz	500 mA at 24V DC	RS485	http://krohne.com/	4,7
Krohne Optiflex 1300C	Pulse	2 GHz	guided-wave radar (~30 cm diameter stilling well required)	3mm if range < 10m, 0,03 % of range if range > 10m	1 Hz	25 mA at 12V DC (less for digital output)	4-20 mA Current Loop/HART (digital)	http://krohne.com/	4,7
VEGAFLEX 81	Pulse	2 GHz	guided-wave radar	2 mm	measuring cycle < 500 msec	21.5 mA maximum at 12V DC	4-20 mA Current Loop/HART	www.vega.com	7
CEETIDE Portable Tide Gauge								www.ceehydro.com	8

Appendix 1 Notes

1. The Kalesto is no longer manufactured and was replaced by the OTT RLS but is still used extensively around the world.
2. There are other VEGAPULS instruments in the same family. According to the IHO Inventory, the VEGAPULS 62 is used in Peru and Spain, although that device is designed for considerably heavier-duty industrial applications than the VEGAPULS 61. Also, according to the IHO Inventory, a Vaisala QHR104 sensor is used in Chile and is used to make 1 min average water levels from 4 Hz samples; in fact, this is also a VEGAPULS 62 with an SDI-12 interface. We understand that the VEGAPULS 62 is also used by German groups. The VEGAPULS 63 is said to be used in Australia as is the C-band VEGAPULS 66 (Mettters and Ryan, Supplement).
3. The Campbell Scientific gauge is a version of the VEGAPULS-61 with an SDI-12 interface.
4. The Krohne BM70 is now replaced by the Optiwave 7300C and the BM100 by the Optiflex 1300C. Probably SHOM were the only users of the earlier versions
5. Different versions of the Miros gauge are available with different ranges and antenna beam widths. A later model SM-140 is available which has redesigned electronics, housing and software and has greater power output.
6. The Radac gauge is available in versions suitable for operation in the open air and in a stilling well.
7. This device does not transmit radar in the open air but down a vertical cable waveguide suspended in a stilling well.
8. This seems to be a rugged radar gauge for port operations or fieldwork deployments.

The instruments in this list include all those mentioned in IHO (2015).

The 'Typical Accuracy' is taken from the manufacturers' information and one should be careful of making judgements on comparative performance based on these values. 'Output' lists only one of the main methods; in some cases the instrument may have several output methods.

N/R = Not Relevant, N/M = Not Mentioned

Appendix 2:

List of Acronyms

AC	Alternating Current
AG	Absolute Gravity
AIS AtoN	Automatic Identification System Aids to Navigation (of the International Maritime Organisation)
ARP	Antenna Reference Point
BAFG	Bundesanstalt für Gewässerkunde, Germany
BGAN	Broadband Global Area Network (of INMARSAT)
BKG	Bundesamt für Kartographie und Geodäsie, Germany
BM	Bench Mark
BODC	British Oceanographic Data Centre
CARIBE-EWS	Tsunami and Other Coastal Hazards Warning System for the Caribbean and Adjacent Regions
CGNSS	Continuous GNSS
CGNSS@TG	Continuous GNSS at Tide Gauges (previously CGPS@TG)
CIU	Coastal Impacts Unit (Queensland, Australia)
CNRS/INSU	Centre National de la Recherche Scientifique/Institut National des Sciences de l'Univers (France)
CP	Contact Point
CREX	Character form for the Representation and Exchange of meteorological data
CW	Continuous Wave (radar)
DAC	Data Assembly Centre
DCP	Data Collection Platform
DCS	Data Collection Service
DM	Delayed Mode (data)
DMQC	Delayed Mode Quality Control
DO	Datum Offset
DORIS	Doppler Orbitography and Radiopositioning Integrated by Satellite
DRGS	Direct Readout Ground Station
EGNSS	Epochal (or Episodic) GNSS
EMODnet	European Marine Observation and Data network
EUMETSAT	European Organization for the Exploitation of Meteorological Satellites
FFT	Fast Fourier Transform
FMCW	Frequency Modulated – Continuous Wave (radar)
FTP	File Transfer Protocol
GEO	Geostationary Earth Orbit
GFZ	Geo Forschungs Zentrum, Potsdam, Germany
GIA	Glacial Isostatic Adjustment
GLOSS	Global Sea Level Observing System

GNSS	Global Navigation Satellite System
GNSSBM	GNSS Bench Mark
GOES	Geostationary Operational Environmental Satellite
GPRS	General Packet Radio System
GPS	Global Positioning System
GRGS	Space Geodesy Research Group (Toulouse, France)
GSM	General Switched Messaging
GTS	Global Telecommunications System
GX	Global Express (INMARSAT)
GWR	Guided-Wave Radar
HDR	High Data Rate
HF/VHF/UHF	High Frequency/Very High Frequency/Ultra High Frequency
HRDCP	High Rate Data Collection Platform
IGN	Instituto Geográfico Nacional, Spain
IP	Internet Protocol
IPGP	Institut de Physique du Globe de Paris, France
ISP	Internet Service Provider
ICSU	International Council for Science
IGS	International GNSS Service
IHO	International Hydrographic Organization
InSAR	Synthetic Aperture Radar Interferometry
IOC	Intergovernmental Oceanographic Commission (of UNESCO)
IOOS	Integrated Ocean Observing System (of NOAA)
IOTWMS	Indian Ocean Tsunami Warning and Mitigation System
IPCC	Intergovernmental Panel on Climate Change
ITRF	International Terrestrial Reference Frame
JASL	Joint Archive for Sea Level (at UHSLC)
JCOMM	Joint Technical Commission for Oceanography and Marine Meteorology (IOC/WMO)
JMA	Japan Meteorological Agency
LAN	Local Area Network
LAT	Lowest Astronomical Tide
LCD	Liquid Crystal Display
LEO	Low Earth Orbit
LIDAR	Light Detection And Ranging
LO	Logger Offset
LoS	Line of Site
M2M	Machine to Machine
MCC	Main Control Centre (of EUMETSAT)
MEO	Mid-altitude Earth Orbit

MSL	Mean Sea Level
MSS	Mean Sea Surface or Mobile Satellite System
MTSAT	Meteorological Satellite system (JMA)
NEAMTWS	Tsunami Early Warning and Mitigation System in the North-eastern Atlantic, the Mediterranean and Connected Seas
NIO	National Institute of Oceanography (India)
NOAA	National Oceanic and Atmospheric Administration (USA)
NOC	National Oceanography Centre (UK)
NODC	National Oceanographic Data Center (USA)
NRC	National Resources Canada
NRT	Near Real Time (data)
NTP	Network Time Protocol
PACT	Process Automation Configuration Tool
PPP	Point-to-Point Protocol
PSMSL	Permanent Service for Mean Sea Level
PSTN	Public Switched Telephone Network
PTT	Platform Transmitter Terminal (of the ARGOS system)
PTWC	Pacific Tsunami Warning Centre
PTWS	Pacific Tsunami Warning System
PZR	Point of Zero Range
QC	Quality Control
RADAR	RAdio Detection And Ranging
REDMAR	Spanish Harbours Authority Sea Level Network
RINEX	Receiver Independent Exchange Format (for GNSS data)
RLR	Revised Local Reference (data set of the PSMSL)
RSM	Reference Survey Mark
RQDS	Research Quality Data Set (of UHSLC)
RT	Real Time (data)
RTH	Regional Telecommunication Hub
RTQC	Real Time Quality Control
RUDICS	Raster-based Unrestricted Digital Internetworking Connectivity Solutions (RUDICS) protocol
SANHO	South African Navy Hydrographic Office
SCP	Secure Copy Protocol
SHOA	Servicio Hidrográfico y Oceanográfico de la Armada (Chile)
SHOM	Service Hydrographique et Océanographique de la Marine (France)
SIM	Subscriber Identity Module
SLSMF	Sea Level Monitoring Facility (of IOC at VLIZ)
SO	Sensor Offset
SONEL	Système d'Observation du Niveau des Eaux Littorales (at University of La Rochelle)

TASK	Tidal Analysis Software Kit (of NOC)
TCXO	Temperature Compensated Crystal Oscillator
TGBM	Tide Gauge Bench Mark
TGZ	Tide Gauge Zero
TIGA	Tide GAuge (project of the IGS)
TOF	Time of Flight
TWC	Tsunami Warning Centre
UHSLC	University of Hawaii Sea Level Center
UNESCO	United Nations Educational, Scientific and Cultural Organization
UPS	Uninterruptible Power Supply
USGS	United States Geological Survey
VLIZ	Flanders Marine Institute
VLM	Vertical Land Movement
VSAT	Very Small Aperture Terminal
WCDAS	Wallops Command and Data Acquisition Station
WDS	World Data System (of ICSU)
WHSU	World Height System Unificatio
WMO	World Meteorological Organization

Appendix 3:

GTS Bulletin Contents and an Example of a DCP Message using CREX Code

GTS Bulletin Contents

Abbreviated Header

WMO headers are determined using WMO definitions. An example from a header originating from a SHOM tide gauge would be SZIO01 EUMS 031216.

The Bulletin Header Code specifies the type and form of the data along with geographical information (6 characters, here SZIO01). The first two characters of this code identify the data type: for tide gauge data, SZ is adequate since "SZ is allocated to sea-level data and deep-ocean tsunami data in any alphanumerical form including CREX".

The next two characters identify the region or area of the DCP: IO stands for Indian Ocean (CA would stand for Caribbean, etc.) and the numbers differentiate between bulletins but do not hold specific meaning.

Then the Originating Location Indicator represents the station originating or compiling the GTS bulletin (4 characters, EUMS). For EUMETSAT DCPs processed by Offenbach RTH the Originating Location Indicator is EUMS.

Following those two first codes is the Date-Time Group that specifies the day of the month and the time (UTC) of the observation or compilation of the bulletin (6 characters, 031216 for a message compilation on the third day of the month at 12:16 UTC)

Code Identifier

The Code Identifier identifies the type of data contained within the message. CREX++ will for example identify a CREX message.

Meteorological Message

The Meteorological Message consists of the actual bulletin data, which can contain up to 15 Kilobytes for ASCII coded messages or 500 Kilobytes of binary coded data. The specification for the timeliness for delivery of DCP bulletins to the GTS interface is within 10 minutes of arrival at the EUMETSAT Mission Control Centre, which can be constraining for early warning system such as tsunami warning in Mediterranean and Caribbean seas. National meteorological offices or institutes equipped with a special equipment (around 10k€/year), such as TWCs, have direct access to GTS in order to get the messages as soon as possible.

For sea level data providers, for which a few extra minutes of delay is acceptable, the sea level data and messages can be visualized and downloaded through the IOC SLSMF. This service, developed and operated by VLIZ under the auspices of IOC, offers tide gauge data providers a unique web tool to share their data. Participation is straightforward and a simple login request allows users to set up a GTS station on the map of the website. It is a free service and no equipment is needed. In 2016, around 900 tide gauges worldwide were displayed, with almost half of them using a GTS connection.

Example of a DCP Message using CREX Code

The following is an example of a message generated by a DCP operated by SHOM. SHOM tide gauge DCPs in the Mediterranean region have a transmit interval of 6 min allowing the transmission of 6 1-min water level measurements. In addition the previous 6 measurement are added to the data section in order to have replicate messages for redundancy. A message thus contains 12 measurements. Data descriptors used in the header allow the user to specify:

- i. CREX version used
- ii. Data type
- iii. Tide gauge location (Lat. /Long.)
- iv. Type of increments
- v. Date of measurements
- vi. Various quality checks
- vii. Measurement datum

The whole message is reproduced and decoded below:

CREX++

T000103 A001 D01021 D06019 R01012 B22038++

4615833 -00122056 FR034 2013 07 01 13 25 //// 11 07 00 01

04038 04023 04009 04002 03989 03975 03962 03951 03934 03922 03907 03907++

7777

Interpretation of the example:

Line	Group	Meaning
1	CREX	Indicator of a CREX message
2	T000103	CREX Master Table Number 00, Edition 01, Version 03
A001	Data type 001:	Surface data – sea
D 01 021		Location with high accuracy lat/long.
D 06 019		Tide report identification, water level checks, time increments
	R01012	Replicate 1 descriptor 12 times
B22038		Tidal elevation with respect to local chart datum
++		End of data section
3	4615833	Latitude: 46.15833 degree
	-00122056	Longitude: -001.22056 degree
FR034		SHOM tide station number FR034
2013	Year:	2013
07	Month:	July
01	Day:	01
13	Hour:	13h UTC

25 Minute of the first measurement in the message: 25
//// No SST data
11 Good data
07 No manual water level checks performed
00 Time increment: 0 minutes applied to the base time of 2013/07/01 13:25 UTC
01 Time increment of 1 minute
4 04038 Tide elevation of 4 038 mm at hour 13h25UTC,
04023 Tide elevation of 4 023 mm at hour 13h26UTC,
.... etc... (12 measurements altogether)
++ end of Data section
5 7777 End of CREX message

IOC Manuals and Guides

No.	Title
1 rev. 2	Guide to IGOSS Data Archives and Exchange (BATHY and TESAC). 1993. 27 pp. (English, French, Spanish, Russian)
2	International Catalogue of Ocean Data Station. 1976. (Out of stock)
3 rev. 3	Guide to Operational Procedures for the Collection and Exchange of JCOMM Oceanographic Data. Third Revised Edition, 1999. 38 pp. (English, French, Spanish, Russian)
4	Guide to Oceanographic and Marine Meteorological Instruments and Observing Practices. 1975. 54 pp. (English)
5 rev. 2	Guide for Establishing a National Oceanographic Data Centre. Second Revised Edition, 2008. 27 pp. (English) (Electronic only)
6 rev.	Wave Reporting Procedures for Tide Observers in the Tsunami Warning System. 1968. 30 pp. (English)
7	Guide to Operational Procedures for the IGOSS Pilot Project on Marine Pollution (Petroleum) Monitoring. 1976. 50 pp. (French, Spanish)
8	(Superseded by IOC Manuals and Guides No. 16)
9 rev.	Manual on International Oceanographic Data Exchange. (Fifth Edition). 1991. 82 pp. (French, Spanish, Russian)
9 Annex I	(Superseded by IOC Manuals and Guides No. 17)
9 Annex II	Guide for Responsible National Oceanographic Data Centres. 1982. 29 pp. (English, French, Spanish, Russian)
10	(Superseded by IOC Manuals and Guides No. 16)
11	The Determination of Petroleum Hydrocarbons in Sediments. 1982. 38 pp. (French, Spanish, Russian)
12	Chemical Methods for Use in Marine Environment Monitoring. 1983. 53 pp. (English)
13	Manual for Monitoring Oil and Dissolved/Dispersed Petroleum Hydrocarbons in Marine Waters and on Beaches. 1984. 35 pp. (English, French, Spanish, Russian)
14	Manual on Sea-Level Measurements and Interpretation. (English, French, Spanish, Russian)
	Vol. I: Basic Procedure. 1985. 83 pp. (English)
	Vol. II: Emerging Technologies. 1994. 72 pp. (English)
	Vol. III: Reappraisals and Recommendations as of the year 2000. 2002. 55 pp. (English)
	Vol. IV: An Update to 2006. 2006. 78 pp. (English)
	Vol. V: Radar Gauges. 2016. 104 pp. and Supplement: Practical Experiences. 118 pp. (English)
15	Operational Procedures for Sampling the Sea-Surface Microlayer. 1985. 15 pp. (English)
16	Marine Environmental Data Information Referral Catalogue. Third Edition. 1993. 157 pp. (Composite English/French/Spanish/Russian)
17	GF3: A General Formatting System for Geo-referenced Data
	Vol. 1: Introductory Guide to the GF3 Formatting System. 1993. 35 pp. (English, French, Spanish, Russian)
	Vol. 2: Technical Description of the GF3 Format and Code Tables. 1987. 111 pp. (English, French, Spanish, Russian)
	Vol. 3: Standard Subsets of GF3. 1996. 67 pp. (English)
	Vol. 4: User Guide to the GF3-Proc Software. 1989. 23 pp. (English, French, Spanish, Russian)
	Vol. 5: Reference Manual for the GF3-Proc Software. 1992. 67 pp. (English, French, Spanish, Russian)
	Vol. 6: Quick Reference Sheets for GF3 and GF3-Proc. 1989. 22 pp. (English, French, Spanish, Russian)
18	User Guide for the Exchange of Measured Wave Data. 1987. 81 pp. (English, French, Spanish, Russian)

No.	Title
19	Guide to IGOSS Specialized Oceanographic Centres (SOCs). 1988. 17 pp. (English, French, Spanish, Russian)
20	Guide to Drifting Data Buoys. 1988. 71 pp. (English, French, Spanish, Russian)
21	(Superseded by IOC Manuals and Guides No. 25)
22 rev.	GTSP Real-time Quality Control Manual, First revised edition. 2010. 145 pp. (English)
23	Marine Information Centre Development: An Introductory Manual. 1991. 32 pp. (English, French, Spanish, Russian)
24	Guide to Satellite Remote Sensing of the Marine Environment. 1992. 178 pp. (English)
25	Standard and Reference Materials for Marine Science. Revised Edition. 1993. 577 pp. (English)
26	Manual of Quality Control Procedures for Validation of Oceanographic Data. 1993. 436 pp. (English)
27	Chlorinated Biphenyls in Open Ocean Waters: Sampling, Extraction, Clean-up and Instrumental Determination. 1993. 36 pp. (English)
28	Nutrient Analysis in Tropical Marine Waters. 1993. 24 pp. (English)
29	Protocols for the Joint Global Ocean Flux Study (JGOFS) Core Measurements. 1994. 178 pp. (English)
30	MIM Publication Series:
	Vol. 1: Report on Diagnostic Procedures and a Definition of Minimum Requirements for Providing Information Services on a National and/or Regional Level. 1994. 6 pp. (English)
	Vol. 2: Information Networking: The Development of National or Regional Scientific Information Exchange. 1994. 22 pp. (English)
	Vol. 3: Standard Directory Record Structure for Organizations, Individuals and their Research Interests. 1994. 33 pp. (English)
31	HAB Publication Series:
	Vol. 1: Amnesic Shellfish Poisoning. 1995. 18 pp. (English)
32	Oceanographic Survey Techniques and Living Resources Assessment Methods. 1996. 34 pp. (English)
33	Manual on Harmful Marine Microalgae. 1995. (English) [superseded by a sale publication in 2003, 92-3-103871-0. UNESCO Publishing]
34	Environmental Design and Analysis in Marine Environmental Sampling. 1996. 86 pp. (English)
35	IUGG/IOCTime Project. Numerical Method of Tsunami Simulation with the Leap-Frog Scheme. 1997. 122 pp. (English)
36	Methodological Guide to Integrated Coastal Zone Management. 1997. 47 pp. (French, English)
37	International Tsunami Survey Team (ITST) Post-Tsunami Survey Field Guide. 2nd Edition. 2014. 120 pp. (English) Post-Tsunami Survey Field Guide. First Edition. 1998. 61 pp. (English, French, Spanish, Russian)
38	Guidelines for Vulnerability Mapping of Coastal Zones in the Indian Ocean. 2000. 40 pp. (French, English)
39	Manual on Aquatic Cyanobacteria – A photo guide and a synopsis of their toxicology. 2006. 106 pp. (English)
40	Guidelines for the Study of Shoreline Change in the Western Indian Ocean Region. 2000. 73 pp. (English)
41	Potentially Harmful Marine Microalgae of the Western Indian Ocean Microalgues potentiellement nuisibles de l'océan Indien occidental. 2001. 104 pp. (English/French)
42	Des outils et des hommes pour une gestion intégrée des zones côtières - Guide méthodologique, vol.II/ Steps and Tools Towards Integrated Coastal Area Management – Methodological Guide, Vol. II. 2001. 64 pp. (French, English; Spanish)
43	Black Sea Data Management Guide (Cancelled)
44	Submarine Groundwater Discharge in Coastal Areas – Management implications, measurements and effects. 2004. 35 pp. (English)

No.	Title
45	A Reference Guide on the Use of Indicators for Integrated Coastal Management. 2003. 127 pp. (English). ICAM Dossier No. 1
46	A Handbook for Measuring the Progress and Outcomes of Integrated Coastal and Ocean Management. 2006. iv + 215 pp. (English). ICAM Dossier No. 2
47	TsunamiTeacher – An information and resource toolkit building capacity to respond to tsunamis and mitigate their effects. 2006. DVD (English, Bahasa Indonesia, Bangladesh Bangla, French, Spanish, and Thai)
48	Visions for a Sea Change. Report of the first international workshop on marine spatial planning. 2007. 83 pp. (English). ICAM Dossier No. 4
49	Tsunami preparedness. Information guide for disaster planners. 2008. (English, French, Spanish)
50	Hazard Awareness and Risk Mitigation in Integrated Coastal Area Management. 2009. 141 pp. (English). ICAM Dossier No. 5
51	IOC Strategic Plan for Oceanographic Data and Information Management (2008–2011). 2008. 46 pp. (English)
52	Tsunami risk assessment and mitigation for the Indian Ocean; knowing your tsunami risk – and what to do about it. 2009. 82 pp. (English)
53	Marine Spatial Planning. A Step-by-step Approach. 2009. 96 pp. (English; Spanish). ICAM Dossier No. 6
54	Ocean Data Standards Series:
	Vol. 1: Recommendation to Adopt ISO 3166-1 and 3166-3 Country Codes as the Standard for Identifying Countries in Oceanographic Data Exchange. 2010. 13 pp. (English)
	Vol. 2: Recommendation to adopt ISO 8601:2004 as the standard for the representation of date and time in oceanographic data exchange. 2011. 17 pp. (English)
55	Microscopic and Molecular Methods for Quantitative Phytoplankton Analysis. 2010. 114 pp. (English)
56	The International Thermodynamic Equation of Seawater—2010: Calculation and Use of Thermodynamic Properties. 2010. 190 pp. (English)
57	Reducing and managing the risk of tsunamis. Guidance for National Civil Protection Agencies and Disaster Management Offices as Part of the Tsunami Early Warning and Mitigation System in the North-eastern Atlantic, the Mediterranean and Connected Seas Region – NEAMTWS. 2011. 74 pp. (English)
58	How to Plan, Conduct, and Evaluate Tsunami Exercises / Directrices para planificar, realizar y evaluar ejercicios sobre tsunamis. 2012. 88 pp. (English, Spanish)
59	Guía para el diseño y puesta en marcha de un plan de seguimiento de microalgas productoras de toxinas. 2011. 70 pp. (Español solamente)
60	Global Temperature and Salinity Profile Programme (GTSP) — Data user's manual, 1st Edition 2012. 2011. 48 pp. (English)
61	Coastal Management Approaches for Sea-level related Hazards: Case-studies and Good Practices. 2012. 45 pp. (English)
62	Guide sur les options d'adaptation en zone côtières à l'attention des décideurs locaux – Aide à la prise de décision pour faire face aux changements côtiers en Afrique de l'Ouest / A Guide on adaptation options for local decision-makers: guidance for decision making to cope with coastal changes in West Africa / Guia de opções de adaptação a atenção dos decisores locais: guia para tomada de decisões de forma a lidar com as mudanças costeiras na Africa Ocidental. 2012. 52 pp. (French, English, Portuguese). ICAM Dossier No. 7.
63	The IHO-IOC General Bathymetric Chart of the Oceans (GEBCO) Cook Book. 2012. 221 pp. (English). Also IHO Publication B-11
64	Ocean Data Publication Cookbook. 2013. 41 pp. (English)
65	Tsunami Preparedness Civil Protection: Good Practices Guide. 2013. 57 pp. (English)

No.	Title
66	IOC Strategic Plan for Oceanographic data and Information Management (2013-2016). 2013. 54 pp. (English/French/Spanish/Russian)
67	IODE Quality Management Framework for National Oceanographic Data Centres (in preparation)
68	An Inventory of Toxic and Harmful Microalgae of the World Ocean (in preparation)
69	A Guide to Tsunamis for Hotels: Tsunami Evacuation Procedures (in preparation)
70	A guide to evaluating marine spatial plans. 2014. 96 pp. (English)

Manuals and Guides 14

Intergovernmental Oceanographic Commission

Manual on Sea Level Measurement and Interpretation Radar Gauges

Volume **V**

*Supplement:
Practical Experiences*

Manuals and Guides 14

Intergovernmental Oceanographic Commission

Manual on Sea Level Measurement and Interpretation Radar Gauges

Volume **V**

*Supplement:
Practical Experiences*

The designations employed and the presentation of the material in this publication do not imply the expression of any opinion whatsoever on the part of the Secretariats of UNESCO and IOC concerning the legal status of any country or territory, or its authorities, or concerning the delimitation of the frontiers of any country or territory.

Editing team:

Philip Woodworth (Chair, NOC, UK)

Thorkild Aarup (IOC, UNESCO)

Gaël André, Vincent Donato and Séverine Enet (SHOM, France)

Richard Edwing and Robert Heitsenrether (NOAA, USA)

Ruth Farre (SANHO, South Africa)

Juan Fierro and Jorge Gaete (SHOA, Chile)

Peter Foden and Jeff Pugh (NOC, UK)

Begoña Pérez (Puertos del Estado, Spain)

Lesley Rickards (BODC, UK)

Tilo Schöne (GFZ, Germany)

Contributors to the Supplement - Practical Experiences:

Daryl Metters and John Ryan (Coastal Impacts Unit, Queensland, Australia)

Christa von Hillebrandt-Andrade (NOAA, USA), Rolf Vieten, Carolina Hincapié-Cárdenas and Sébastien Deroussi (IPGP, France)

Juan Fierro and Jorge Gaete (SHOA, Chile)

Gaël André, Noé Poffa, Guillaume Voineson, Vincent Donato, and Séverine Enet (SHOM, France) and Laurent Testut (LEGOS, France)

Stephan Mai and Ulrich Barjenbruch (BAFG, Germany)

Elke Kühmstedt and Gunter Liebsch (BKG, Germany)

Prakash Mehra, R.G. Prabhudesai, Antony Joseph, Vijay Kumar, Yogesh Agarvadekar, Ryan Luis, M. Soumya, Bharat Harmalkar and Devika Ghatge (NIO, India)

Hironori Hayashibara (JMA, Japan)

Ruth Farre (SANHO, South Africa)

Begoña Pérez (Puertos del Estado, Spain), Diana López and José María Cortés (SIDMAR, Spain) and Bernat Puyol (IGN, Spain)

Jeff Pugh, Peter Foden, Dave Jones, Philip Woodworth and Angela Hibbert (NOC, UK)

Travis Mason (Channel Coastal Observatory, UK) and Robin Newman (Fugro EMU Ltd., UK)

Richard Edwing and Robert Heitsenrether (NOAA, USA)

Janice M. Fulford (USGS, USA)

Other information was provided by Les Bradley (NOC, UK), Pat Caldwell and Mark Merrifield (UHSLC, Hawaii, USA), Médéric Gravelle and Guy Wöppelmann (University of La Rochelle, France), Lonny Hansen, Vibeke Huess and Klavs Allerslev (Danish Meteorological Institute) and Belén Míguez Martín (EMODnet, Ostend, Belgium).

In addition, the editing team is grateful to Christoph Blasi (BAFG, Germany), John Boon (USA), John Broadbent (Maritime Safety, Queensland, Australia), Peter Devine (Technical Director, VEGA Controls Ltd., UK), Terry Edwards (Technical Director, RS Aqua Ltd., UK), and Øistein Grønlie (Senior Technical Advisor, Miros, Norway) and Elena Iasyreva (IOC).

Publication designer: Ahmad Korhani, UNESCO. Original design by Eric Loddé.

For bibliographic purposes this document should be cited as follows:

Manual on Sea-level Measurements and Interpretation, Volume V: Radar Gauges; Supplement: Practical Experiences. Paris, Intergovernmental Oceanographic Commission of UNESCO. 126 pp. (English only)
(IOC Manuals and Guides No.14, vol. V; JCOMM Technical Report N° 89)

Printed in 2016

By the United Nations Educational, Scientific and Cultural Organization
7, place de Fontenoy, 75352 Paris 07 SP

© UNESCO 2016

Printed in France

(IOC/2016/MG/14Vol.5 Suppl. Rev.)

Table of Contents

Comparison between C-band and K-band Radar Sensors; Experiences from Queensland (Australia).....	5
Radar Gauges in the Caribbean	13
Strengthening the Chilean Sea Level Network	19
Experience with Radar Gauges at SHOM (France).....	33
Water Level Measurements with Radar Gauges at the German North Sea Coast	43
Experiences with Radar Gauges at BKG (Germany)	53
Experience with Downward-looking Aerial Microwave Radar Based Sea-level Gauges deployed along Indian Coasts and Islands.....	65
Comparison Test of Radar Gauge and Float Gauge at JMA (Japan)	75
Experiences with Radar Gauges by the South African Navy Hydrographic Office	77
Use of a Stirrup to Calibrate a Radar Gauge (South Africa)	81
Experiences with Radar Gauges for Sea Level Measurement in Spain	85
Channel Coastal Observatory Experiences with Radar Gauges (U.K.)	95
Experiences with Radar Gauges at NOC (U.K.)	101
Recent Test, Evaluation, and Operational Use of Radar Water Level Sensors by the United States National Oceanic and Atmospheric Administration	111
Testing and Use of Radar Water Level Sensors by the U.S. Geological Survey	121

Comparison between C-band and K-band Radar Sensors; Experiences from Queensland (Australia)

Daryl Metters and John Ryan
Coastal Impacts Unit,
Department of Science, Information Technology and
Innovation, Queensland, Australia

*Contact person: D. Metters
E-mail: daryl.mettters@dsiti.qld.gov.au*

○ Introduction

The Coastal Impacts Unit (CIU) operates a network of Storm Tide monitoring gauges along the Queensland coast. The gauges provide water level information during extreme weather events (see www.qld.gov.au/tides). The information from the network is used by emergency management agencies and local councils for disaster management purposes. During normal conditions the data contributes to the basis of tide predictions for the state and is utilized for many other purposes including recreational activities, maritime safety, coastal engineering and scientific modelling.

The coastal regions of Queensland vary widely with respect to the physical wave climate. The variation is largely due to the differing degree of exposure to the

open ocean. The storm tide monitoring network has 34 storm tide monitoring gauges situated along the Queensland coast at locations that are subject to these variations in the wave climate (**Figure 1**). The variation ranges from low wave energy sites like Mossman River through medium wave sites such as Mackay and Weipa to the extreme end of the wave climate, high energy sites such as the Gold Coast. All of the storm tide monitoring sites may at some point be exposed to extreme weather events such as tropical cyclones.

It is very important to have an understanding of how the levels from a storm tide monitoring gauge are reported, that is, understand what level of damping/smoothing is applied to remove unwanted high frequencies and the sampling method employed. Having this understanding helps when interpreting the data output. Using sensors

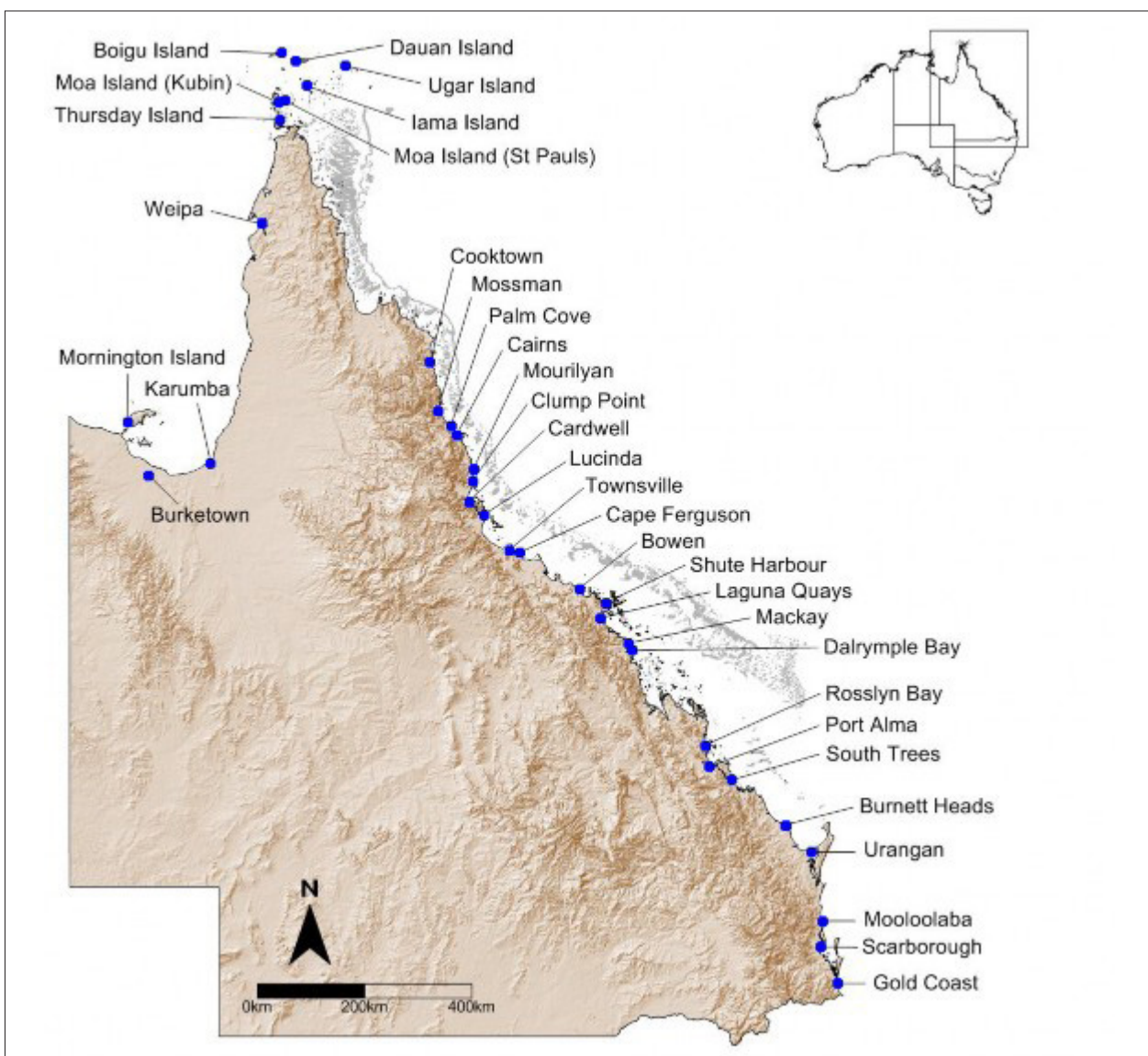

Figure 1. Location of Storm Tide monitoring gauges in Queensland, Australia, for more visit www.qld.gov.au/tides.

that are potentially under or over reporting the water level during storm events is not desirable, hence the influence of high frequency wave action on the data must be reduced wherever possible. This has been achieved historically across the storm tide gauge network by enclosing the sensor within a stilling well. The CIU sensor of choice for stilling wells is the guided wave microwave sensor.

The CIU also uses radar sensors as a secondary sensor at all of the storm tide monitoring sites; these are open-to-air microwave-based sensors. The CIU has taken these up as a redundant sensor, mostly because of their reliability, lack of operational parts in the water and because they are unaffected by gas composition, pressure and temperature changes. Smoothing of the output is achieved at the sensor via integration (generally over two minutes) of the high frequency pulse. Within a high energy environment wave action can be difficult to eliminate from the record using two minute integration alone.

There are two main types of microwave based sensors available for measuring sea level. The CIU uses the compact high frequency K-band sensors (Puls61 and Puls62). These are a low cost option that are assumed to be well suited to low energy and relatively calm applications. These sensors have been installed as redundant sensors at many of the CIU storm tide monitoring sites.

There are a few sites that are situated within high energy environments where large waves and regular storms introduce large variabilities into the water level signal. For these sites the low frequency C-band (Puls66) sensor has been used. The decision to use these sensors was based on claims by the manufacturer:

The low frequency C-band sensors can penetrate foam and strong condensation and are thus particularly suitable for arduous process conditions... (Vega, 2015).

The low frequency sensor should give a better representation of actual water level in a high energy environment as they should penetrate through sea spray and foam associated with high seas and strong winds. As the suitability of the low frequency C-band sensors is yet to be verified in the field under normal operational conditions, the CIU set out to investigate whether this claim was indeed true and can be applied to measuring sea level under extreme conditions.

There is a new function available for the Puls62 sensor that introduces the capability of reporting wave height. The sensor is fitted with a different antenna (parabolic)

that gives a smaller footprint than the standard Puls62. This pilot study included both types of Puls62 sensors so that a comparison could be made between the standard and narrower footprint models.

○ Methods

The Tweed River Entrance Sand Bypass jetty (**Figure 2**) was selected for the test site as there is no public access and it is exposed to a high energy wave environment. The jetty also has access to power and 3G cellular bandwidth is available for communication with the sensors and data retrieval.

The planned focus of the test was two-fold. The first is a comparison between the performance (smoothing ability) of four sensor types: (1) Puls61; (2) Puls62 horn antenna; (3) Puls62 parabolic antenna; and (4) Puls66 (see Table 1) in measuring sea level based on CIU objectives. In order to achieve a sound comparison, ideally at least one extreme event should be recorded. As extreme events are difficult to predict, an environment with similar conditions such as foam and sea spray was selected. The second objective was to investigate extending sensor integration levels from two minutes to four minutes, to determine whether further smoothing of the signal could be achieved.

The four sensors were installed across the end of the Tweed River Entrance Sand Bypassing jetty on 12 December 2013. The initial sensor setup mirrored the setup that the CIU uses in the field. The sensor integration was set to two minutes and the level reported every minute, such that the time stamp coincided with the end of the two minute integration period. Integration was reset to four minutes (with one minute reporting) for the second part of the study.

There were two periods selected for the comparison that encapsulated one tidal cycle. These were around the same time of year (1) January 24 to February 7 2014 and (2) February 14 to 28 2015. The wave conditions were similar for both of the test periods. The CIU wave buoy moored 2 km off-shore from the test site in 22 m waters recorded average maximum wave height (Hmax) of 2.44 m and 3.21 m respectively over the test periods.

The non-tidal residual was generated for each sensor output. This was calculated by subtracting the predicted tide level from each one minute reading. The residual was reduced to an average zero by subtracting the average of all the residual from each residual value. This enabled fair comparisons between sensor datasets.

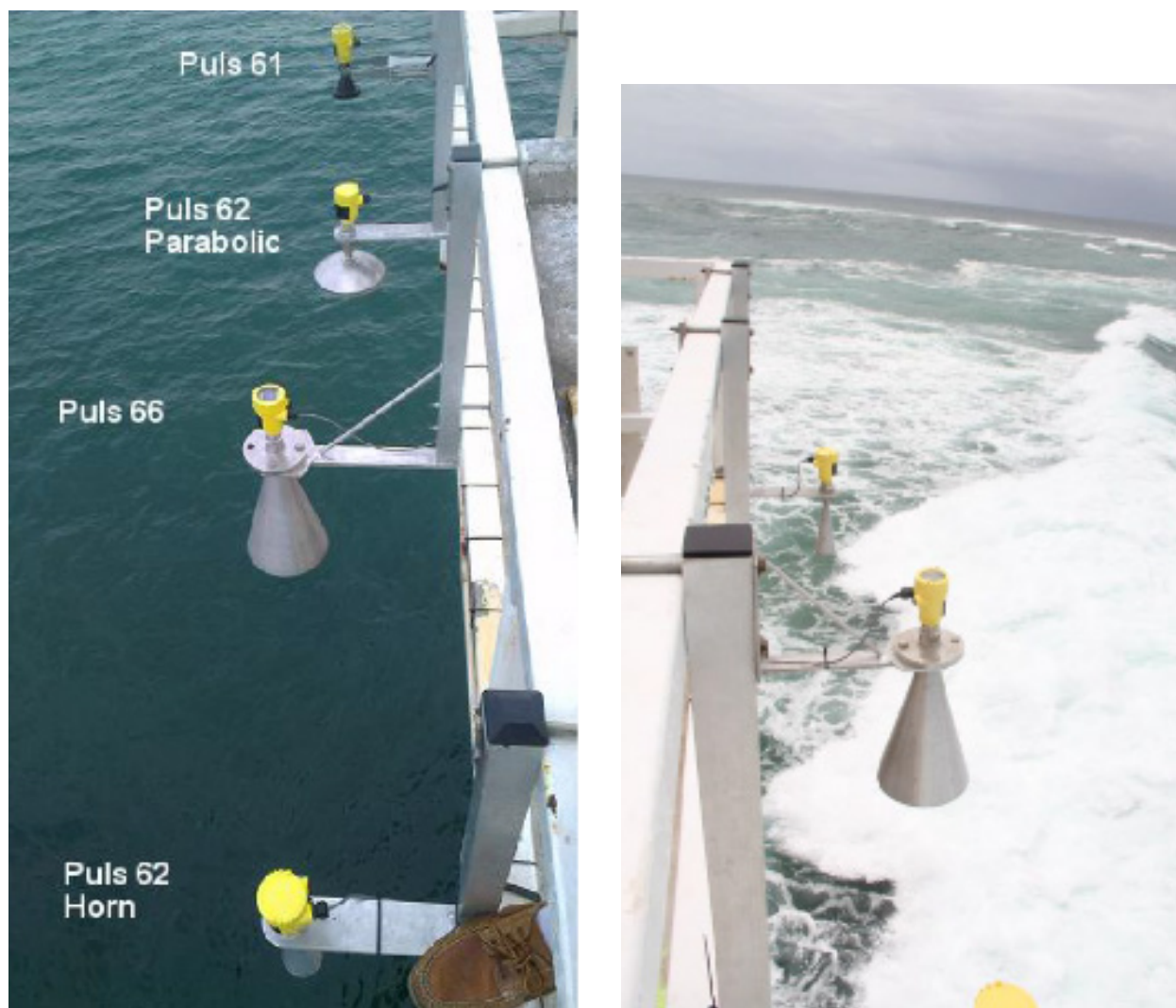

Figure 2. Radar sensor array across the end of the Tweed River Entrance Sand Bypass jetty, right image shows waves breaking under the sensors.

Table 1. Sensor name, frequency, sensor accuracy, beam angle (Vega 2015a) and footprint.

Sensor	Frequency	Beam angle	Beam footprint at 8.3 m (m)	Sensor accuracy
Vega Puls61	K-band	10	1.45	± 2 mm
Vega Puls62 parabolic	K-band	3	0.43	± 2 mm
Vega Puls62 horn	K-band	10	1.45	± 2 mm
Vega Puls66	C-band	14	2.04	± 8 mm

○ Results

The resulting residuals as well as the recorded wave heights at the wave buoy are shown in **Figures 3 and 4**. The non-tidal residual under two minute and four minute integration was considerably smoothed with the Puls66 sensor compared to the other four sensors. The range of the residual of the Puls66 was around half that of the Puls61, by up to 50 cm less. The Puls66 residual range was also lower than that of both Puls62 sensors by 32 cm to 62 cm (**see Tables 2 and 3**).

A visual check of the residual plots would suggest that the level of noise in the residual is clearly reduced with the Puls66 under both integration levels. This is particularly obvious under two minute integration when maximum wave heights exceeded 2 metres.

The standard deviation of the residual is only slightly lower under four minute integration. The residual range and the level of noise is lower under four minute integration than under two minute integration for all sensor types.

Table 2. Two minute integration: residual minimum, maximum, range and standard deviation.

Sensor	Residual Range (m)	Maximum Residual (m)	Minimum Residual (m)	Residual sd
Vega Puls61	1.17	0.71	0.46	0.12
Vega Puls62 parabolic	1.01	0.63	0.38	0.12
Vega Puls62 horn	1.25	0.86	0.39	0.13
Vega Puls66	0.63	0.28	0.35	0.11

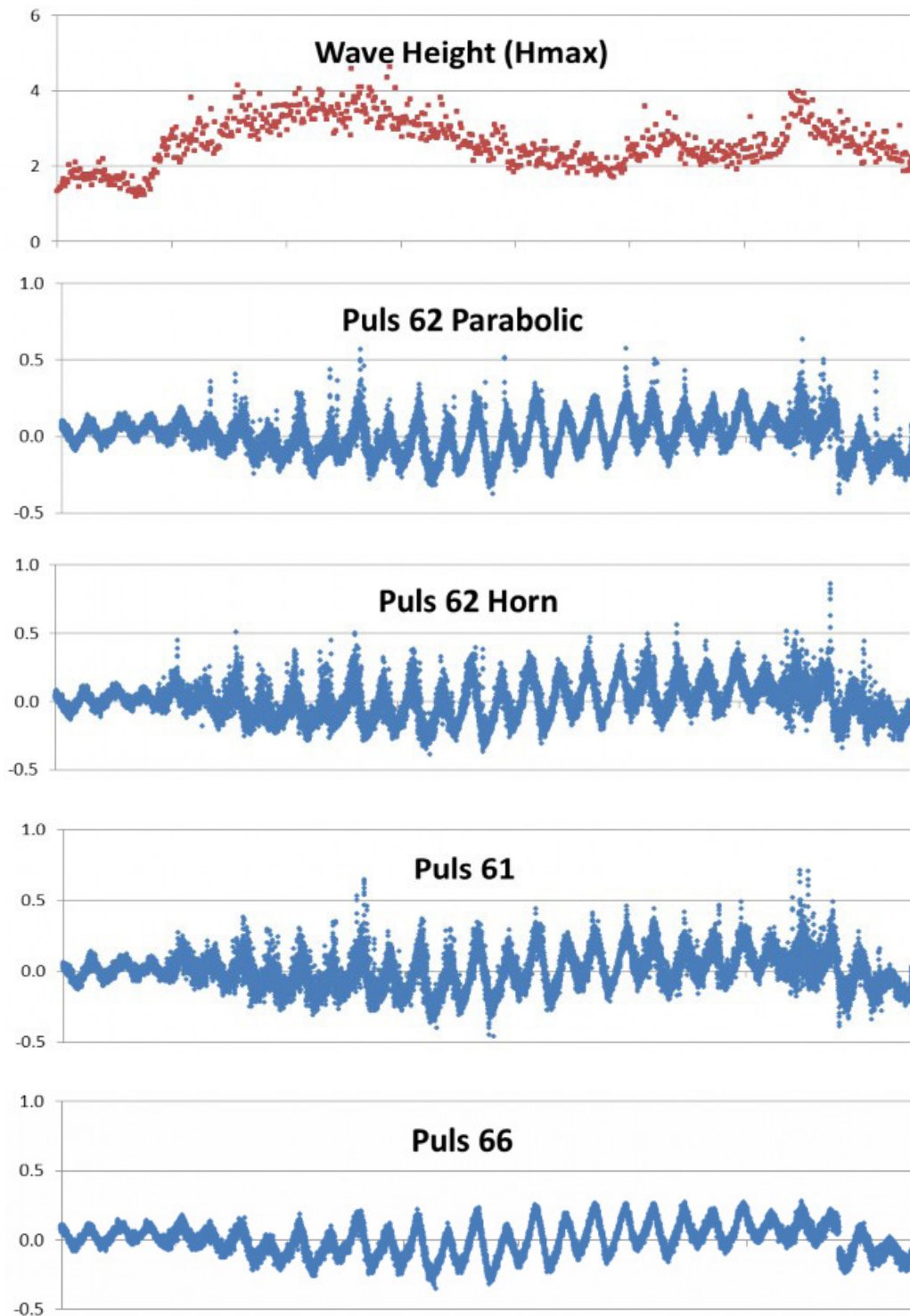

Figure 3. Wave height (Hmax, m) from the Tweed Heads wave buoy and tidal residual for four radar sensors with two minute integration, recorded over one tidal cycle (24/01/15 to 7/02/15).

Table 3. Four minute integration: residual minimum, maximum, range and standard deviation.

Sensor	Residual Range (m)	Maximum Residual (m)	Minimum Residual (m)	Residual sd
Vega Puls61	1.02	0.64	0.38	0.11
Vega Puls62 parabolic	0.93	0.54	0.39	0.10
Vega Puls62 horn	0.86	0.52	0.34	0.11
Vega Puls66	0.52	0.22	0.30	0.09

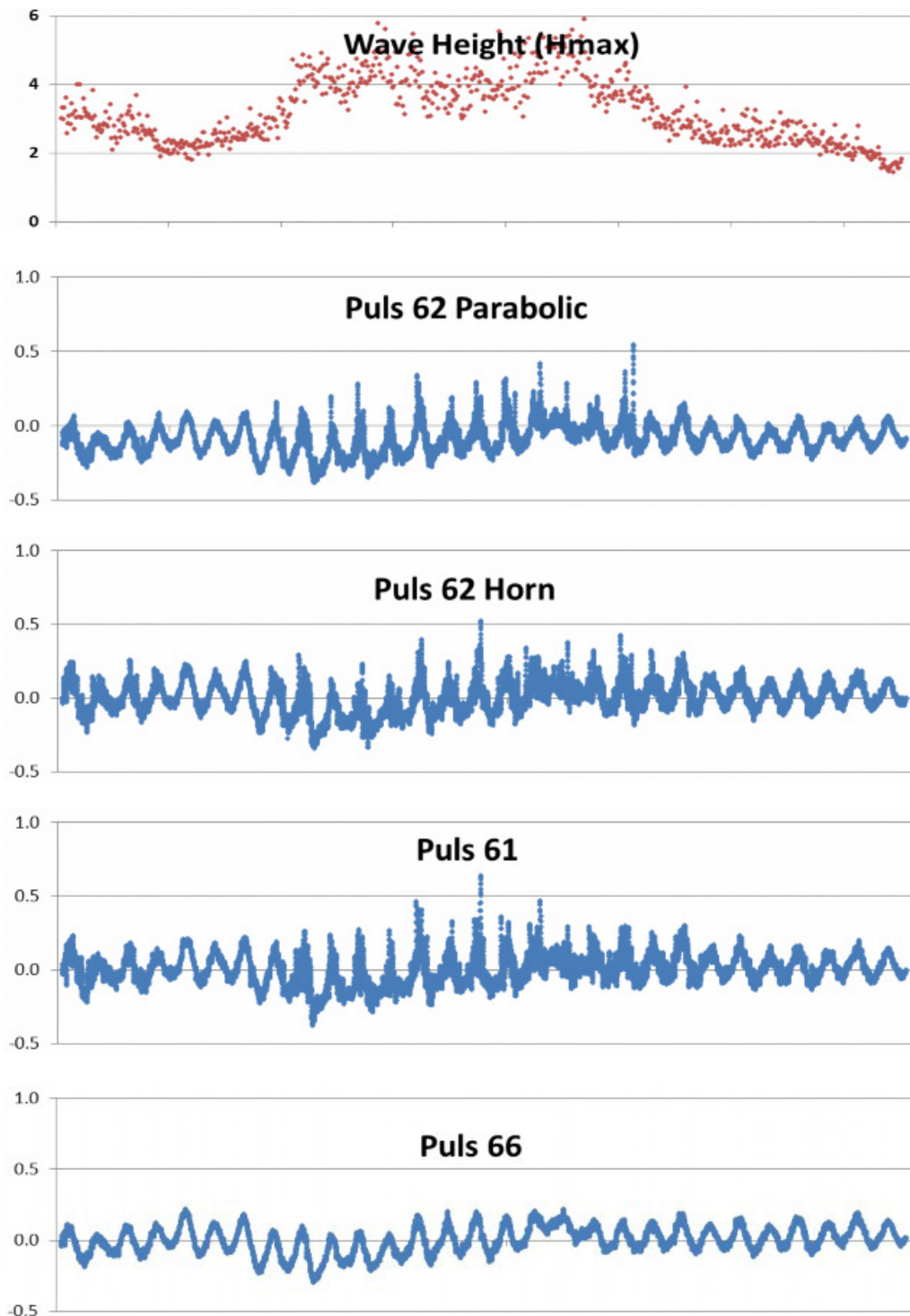

Figure 4. Wave height (Hmax, m) from the Tweed Heads wave buoy and tidal residual for four radar sensors with four minute integration, recorded over one tidal cycle (14/02/14 to 28/02/14).

○ Conclusions

There is a clear distinction between the smoothing capabilities of the four sensors tested here. The C-band sensor was the clear winner with respect to removing the influence of wave action in the output. This verifies beyond doubt that the manufacturers claim “The low frequency C-band sensors can penetrate foam and strong condensation” is also true under the high levels of foam and sea spray of breaking waves. It may also provide the level of smoothing required during extreme weather events.

As the C-band sensor used here also has a larger footprint than the other sensors in this test, this may have contributed to smoothing of the output. However, the level of smoothing due to this or the lower frequency sensor is unknown.

This study would also appear to indicate that there is an advantage to using four minute integration over two minute integration however this cannot be taken as conclusive evidence as the two periods of measurement were not simultaneous.

○ References

Vega (2015a). Product information, Radar, Level measurement in liquids, <http://www.vega-americas.com>, downloaded 15/05/2015.

Vega (2015b). Radar, Continuous level measurement, <http://www.vega-americas.com>, downloaded 15/05/2015.

○ Acknowledgements

This article has been prepared by the Coastal Impacts Unit of the Department of Science, Information Technology and Innovation. Acknowledgement is made to the Tweed River Entrance Sand Bypass Facility for jetty and power access, and to the Coastal Impacts Unit technical staff.

Radar Gauges in the Caribbean

Christa G. von Hillebrandt-Andrade¹, Rolf Vieten²,
Carolina Hincapié-Cárdenas¹ and Sebastien Deroussi³

¹ NOAA, National Weather Service Caribbean Tsunami Warning
Program, Mayagüez, Puerto Rico

² Marine Science Department, University of
Puerto Rico at Mayagüez, Puerto Rico

³ Institut de Physique du Globe de Paris, Volcanological and
Seismological Observatories of Guadeloupe

Contact person: C.G. von Hillebrandt-Andrade
E-mail: christa.vonh@noaa.gov

○ Introduction

Sea level stations are an important component of coastal observation systems with multiple applications. Over the past decades there had been several attempts in the Caribbean to establish a regional sea level network. Oftentimes sea level stations were installed, but over time these fell into disrepair. Nevertheless, in response to the devastating Indian Ocean tsunami in 2005, the Caribbean and other Coastal Hazards Warning System for the Caribbean and Adjacent Regions (known as CARIBE-EWS) was established by the UNESCO Intergovernmental Oceanographic Commission (IOC). Given that one of the key assets for the detection and evaluation of tsunami impact are sea level stations, significant efforts have been made by Member States and donor countries to install and maintain sea level stations. While only 5 sea level stations were available in real time in 2004, 11 years later in 2016 there are 68 coastal sea level stations contributing to the CARIBE-EWS as well as available for many additional applications. While at the beginning most sea level stations consisted of pressure, acoustic sensors and/or bubblers, in recent years operators among many networks have decided to include radar sensors in their station set-ups. The experience so far has shown that radar sensors are much more resilient to the environmental conditions and more cost effective. It seems that radar sensors are technically mature equipment and well suited for the Caribbean. The ease of installation and maintenance also is an advantage.

○ The CARIBE-EWS sea level network

Real-time data sea level networks are one of the essential components of tsunami warning systems. When an earthquake occurs, seismic data are used to establish the potential tsunami threat. Once sea level data are available they are used to confirm tsunami generation, validate tsunami forecast, monitor tsunami wave activity and declare that the threat is over. In the case that the tsunami is generated by a non-seismic source, the sea level data will be the primary tool for the detection and evaluation of the threat. There are different types of instrumentation that can be used to detect tsunami waves: coastal sea level stations, Deep-ocean Assessment and Reporting of Tsunamis (DART®) and HF Radar, among others. This report focuses on coastal sea level stations.

As of March 2016, a big improvement on the number of available coastal sea-level stations was noted by the Intergovernmental Coordination Group (ICG) for CARIBE-EWS. Over the past years, the network has grown from a handful of stations to 68 coastal sea level stations and 7 DARTS. In 2016, the Eleventh Session of the ICG approved the document *Technical, logistical and administrative requirements of a Regional Tsunami Service Provider for the CARIBE EWS* (IOC, 2016). This document includes the criteria and standards for the siting, sensor accuracy and precision, leveling procedures, data processing and other factors for sea level stations. Global Sea Level Observing System (GLOSS) requirements were also included in the development of these criteria.

To monitor and analyze the sea level data most Member States heavily rely on the IOC Sea Level Station Monitoring Facility as well as the Tide Tool program developed, supported and distributed by the Pacific Tsunami Warning Center (PTWC) and the International Tsunami Information Center (ITIC). The Caribbean Tsunami Warning Program (CTWP) monitors the status of sea level stations and works together with operators for the installation and operation of these stations. In the region there has yet to be a center established for the archiving and analysis of all sea level data from the Caribbean. Different institutions, including the US National Oceanographic and Atmospheric Administration (NOAA), French Naval Hydrographic and Oceanographic Service (SHOM), University of Hawaii Sea Level Center, as well as other universities within the region are responsible for different subsets of data.

Over the past years there has been a notable increase in radar sensors installed as primary or auxiliary sensors. As of 2016, according to the database of sea level stations maintained by the CTWP, there are 42 (62%) stations contributing data that use radar for at least one of their sensors (**Figure 1**).

○ Radar Configuration

There is no common station set up for radar gauges throughout the Caribbean region. There are approximately a dozen types of installation: some are common to a country, while others exist in several countries and were sponsored through regional projects. Each operator has chosen its data collecting platform, manufacturers and mounting of components. Most radars are open air, but



Figure 1. Map showing all sea level station in the Caribbean. Stars mark the position of sea level stations that have a radar sensor installed.

French “stations” have been installed with guided radar level meters. In most stations, there is at least one other sea level sensor installed. Figure 2 has several examples of stations with radar sensors in the Caribbean and Adjacent Regions.

The Deshaies, Guadeloupe station (Figure 2 [a] and [b]) was installed and is operated by the Institut de Physique du Globe de Paris (IPGP) and Observatoire Volcanologique et Sismologique de Guadeloupe (OVSG) in close collaboration with the SHOM. The main sensor is a guided radar level meter Optiflex 1300c from the Krohne company. This instrument uses Time Domain Reflectometry (TDR) to make the measurements. The accuracy and repeatability of the instrument are 3 and 1 mm, respectively and it has a resolution of 1 mm. The waveguide is a stainless steel cable protected by a 5 meters stilling well directly attached to the plate of the radar. The bottom of the stilling well has a cap pierced with a hole. The ratio between the inside diameter of the tube and the hole forces the characteristics of the filter. Following recommendations from SHOM, a ratio of 10 was initially chosen to remove significant chop and swell. Due to organic concretions quickly clogging the hole, its diameter was enlarged to 2 cm. This modification had no impact in the data. A small report on the installation of this station is available (Deroussi, 2012). Another example

is the Pointe-à-Pitre sea level station. In Pointe-à-Pitre, the stilling well was built in concrete in 1985, it is 1m wide and the hole allowing the circulation of water is 10 cm wide. In this case, no modification of the hole has been needed.

NOAA operates with the Puerto Rico Seismic Network 10 sea level stations in Puerto Rico and the US Virgin Islands. The configuration of most of these stations consists of acoustic, bubbler and/or pressure sensor. In 2015 NOAA reconfigured the station in Mayagüez and it now only has two microwave radar sensors (Figure 2 [c]). As with other NOAA stations, the sensor installed is a Xylem\WaterLog H-3611.

The UHSLC operates 10 sea level stations in the Caribbean and Adjacent Regions. The configuration of these stations includes a radar, in addition to a pressure sensor and/or bubbler (Figure 2 [d]). The radars being used include Sutron radar model RLR-0003 and Vega radar model Vegapuls 62.

Overall the experience has been that the radars are more resilient than sensors that are in contact with the water, especially because of biofouling issues. While operators like IPGP, NOAA and UHSLC regularly perform datum control and levelling, many individual operators have limited resources to perform this task.



Figure 2 [a] and [b]. Top view [a] and side view [b] of the hatch and housing of the radar sensor in Deshaies, Guadeloupe. The hatch was designed with two functions: first to facilitate the leveling of the radar plate and second to be able to manipulate the stilling well with a crane if necessary (Credit Photo: Sebastien Deroussi, Institut de Physique du Globe de Paris).



Figure 2 [c]. Double radar sensor configuration in Mayagüez, Puerto Rico (Credit Photo: Jose Cancel, Puerto Rico Seismic Network).



Figure 2 [d]. Punta Cana sea level station operated by the University of Hawaii Sea Level Center (UHSLC) with the National Office for Meteorology in the Dominican Republic (ONAMET). This single radar configuration is similar to that used by UHSLC at this as well as 9 other stations in the Caribbean and Adjacent Regions (Photo Credit: Nikolai Turetsky, UHSLC)

Overview of Radar Data

Using the IOC Sea Level Station Monitoring Facility, the data from different radar stations has been reviewed. When other sensors are available at the same site, the data compares favorably. Below, graphical outputs for a thirty day period from the IOC Sea Level Station Monitoring Facility are presented. Of special note is that in general there is no significant difference between the guided radars and open air radars and between the well-established sensors.

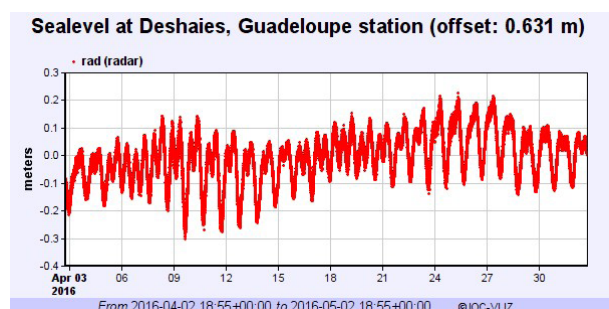

Figure 3. 30 days of data from the Deshaies, Guadeloupe station. The sensor is a guided wave radar and is operated by the IPGP in close collaboration with SHOM.

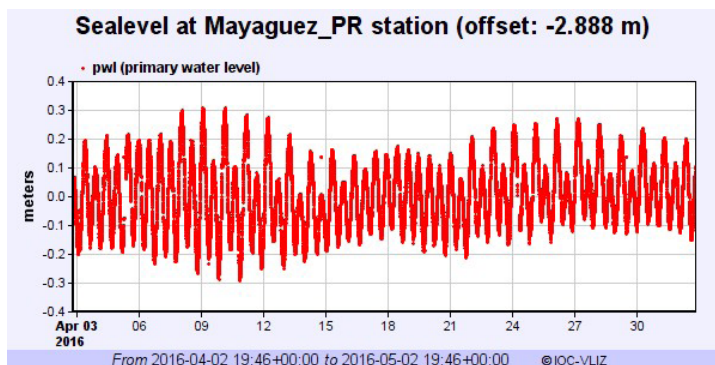

Figure 4. 30 days of data from the Mayaguez, Puerto Rico sea level station operated by NOAA with the Puerto Rico Seismic Network. Only the data from the primary radar sensor is displayed.

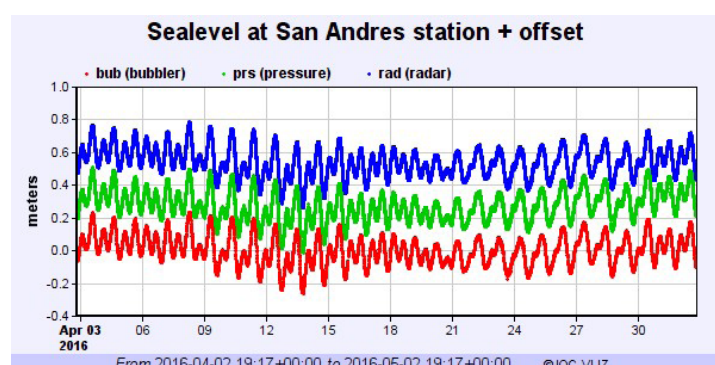

Figure 5. 30 days of data from the San Andres, Colombia sea level station operated by the UHSLC in close collaboration with the Colombian Navy. The data from the radar compares favorably with the data from the bubbler and the pressure sensor.

Conclusions

The Caribbean and Adjacent Regions have embraced radars as one of the main sensors for sea level observation, the main advantage being that by avoiding contact with water, issues with biofouling which plague other sensors are avoided. While for some stations datum control and levelling information is available, this is not the case for all stations. There are currently enough radar gauges and data that a future in-depth study of their performance is merited.

References

- Deroussi, S. 2012. Deshaies tide gauge. Description and construction. IPGP-OSVG Report dated December 2012. 14pp.
- Intergovernmental Oceanographic Commission. 2016. Technical, logistical and administrative requirements of a Regional Tsunami Service Provider for the CARIBE EWS. ICG/CARIBE EWS Tsunami Service Model Task Team document April 2016. 19pp.

Strengthening the Chilean Sea Level Network

Juan Fierro and Jorge Gaete
Chilean Navy Hydrographic and Oceanographic Service (SHOA),
Casilla 324, Valparaiso, 237-0168, Chile

*Contact person: J. Fierro
E-mail: oceanografia@shoa.cl*

○ Introduction

The Hydrographic and Oceanographic Service of the Navy (SHOA), has the task of directing, performing and controlling tidal observations that are carried along the Chilean coast. To fulfill this goal SHOA keeps a network that currently comprises 40 permanent sea level stations distributed along the coast in the continental, insular and Antarctic territory.

The methodical observations of sea level began in 1941, gradually increasing the number of stations and using for this purpose chart recorder analog-mechanical equipment, initially associated with a stilling well gauge and later pneumatic bubbler gauges for measuring sea level as the result of hydrostatic pressure changes. The technological development of instruments triggered an upgrade of the equipment, since 1999, which considered replacement of the mechanical instruments with limited autonomy by digital data collecting platforms, installing in every station a Handar model 555C datalogger, with the capability to incorporate different oceanographic and meteorological sensors, plus the option to transmit through satellite systems the data collected at the sea level station.

During the first half of 2010, a new modernization process of 17 stations sea level operating with satellite telemetry was initiated, which considered the use of the platform

manufactured by Vaisala model MAWS 110, replacing the former 555C model. In every station was also installed a redundant sea level sensor which operated on radar waves and timely observations were available using a higher frequency data transmission through GOES as a primary telemetry system jointly with secondary telemetry systems such as Inmarsat-BGAN and GPRS that enabled the reception of data in real time at SHOA headquarters.

As a consequence of the huge tsunami that struck the coast of Chile on February 27th 2010, emerged the need for more information to detect changes in sea level. Thus was also considered the densification of the national tide gauge network, a process that allowed our country to currently operate 40 real time sea level stations.

The renewal of instruments and higher density of stations improves the operational capabilities of the Chilean sea level station network. The real-time monitoring supports the operation of the National Tsunami Warning System, supplying tide data during hydrographic surveys and provide relevant information for navigation and engineering activities that take place in the coastal areas. Also, strengthening the network of stations allowed our Service to extend the sea level database required for several scientific studies, such as global sea level rise and climate change, among others.

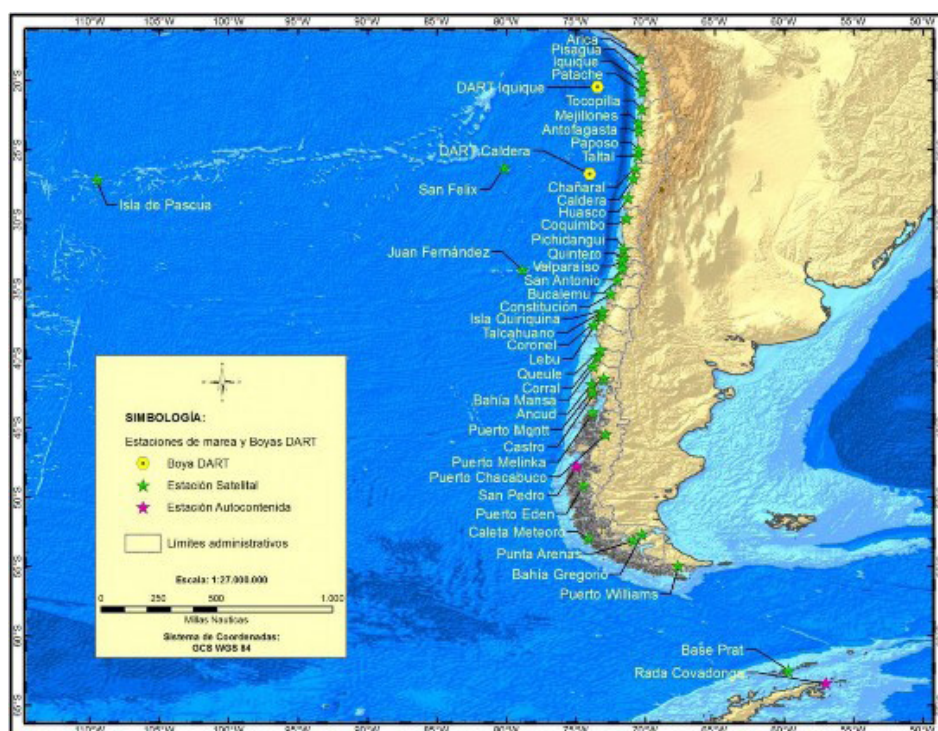

Figure 1. Chilean sea level network.



Figure 2. Views of the mid-size MAWS 110 enclosure.



Figure 3. QML datalogger with cover.

○ Current distribution of sea level stations

The sea level stations operate in specific locations distributed along the Chilean coast, including remarkable islands. Those are preferably installed in places in which there are port facilities with greater densification in the north and central areas of Chile, where most seismic activity occurs and where important coastal towns and marine terminals are located. By the end of 2014 the Chilean sea level network had the distribution that is shown in [Figure 1](#).

○ Data Collecting Platform and Mounting of components

The data acquisition system used at the stations is the Vaisala HydroMet System MAWS110 ([Figure 2](#)). This platform has a compact and robust design with medium-size dimensions. The system is especially designed for unattended operations at sites where main power is not always available, with usual solar panel for daylight operation and battery back-up during the night. The DCP can be equipped with the sensors and telemetry options according to the user's convenience. The manufacturer also provides installation frames and several kinds of enclosures highly resistant to corrosion, ultra-violet radiation and atmospheric agents.

The main component of the platform is the datalogger QML (currently QML201C upgrade) consisting of a 32-bit microprocessor capable of recording, storing and data

transmission. The connection block includes 10 measurement channels and an internal channel for atmospheric pressure measurement, different energy supply options, standard communication channels (RS-232, RS-485 and SDI-12) and optional communication modules.

The QML datalogger is designed to operate in environments with high humidity, requiring low power consumption and incorporates advanced user configurable software, and a connector for flash memory card offering higher data storage capacity ([Figure 3](#)). The cover of the logger can be removed for resetting the platform or modifying communication modules for different sensors or telemetry options.

The more recent upgrade process also considered the renovation and improvements in fixing and supporting structures of the different components that make up the sea level station.

A pair of galvanized steel mast forming a type "H" structure was mostly used for installing many of the devices and sensors, while an alternative system installed in a couple of places consists of a pyramid made of equal leg angles and round tubes of aluminum to support the majority of components. Both structures were fixed to the concrete pier.

The radar water level sensor usually has been installed on a mast attaching a horizontal arm that supports the sensor. In a few stations, the radar sensor was directly installed on a seawall, or another vertical structure mounting the sensor support arm directly on it. In both cases the location of the sensor support arm must be such that the

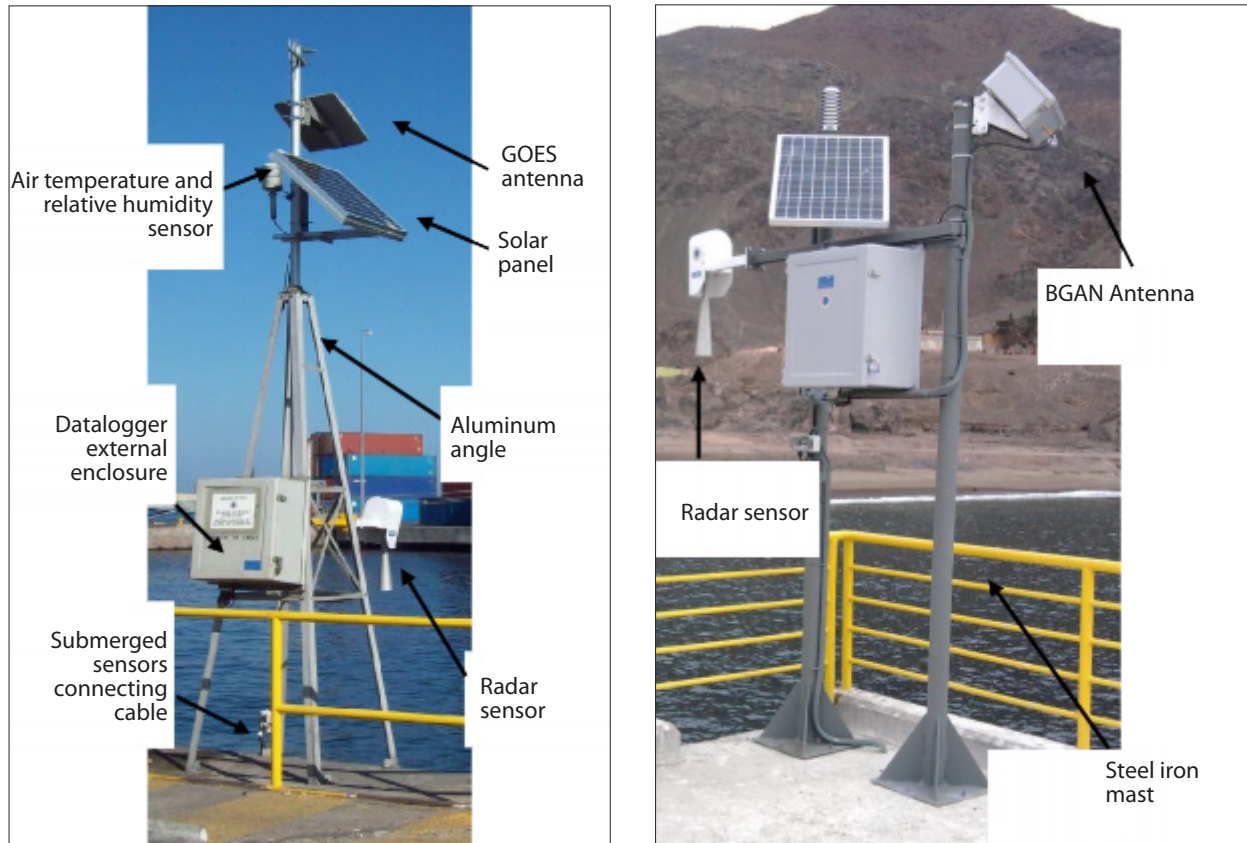

Figure 4. Sea Level Stations of Antofagasta (left) and Taltal (right).

sensor has enough elevation over the water surface and there is sufficient clearance for the radar beam.

In turn, for the installation of submerged sensors fiberglass rulers and PVC hydraulic pipes 50 mm and electrical conduit of 32 mm were used, which were fixed to the pier or seawall by bolts, clamps, and stainless steel bands, according to the conditions at each particular site.

In Figure 4, components and mounting structure used in the ports of Antofagasta (Latitude: 23° 39' S; Longitude: 70° 25' W) and Taltal (Latitude: 25° 25' S; Longitude: 70° 29' W) are shown.

The sea level stations are installed with a standard configuration of sensors that allows monitoring of the following oceanographic and meteorological parameters:

- Sea level
- Water temperature
- Air temperature
- Relative humidity
- Atmospheric pressure

For the purpose of observing sea level, each station has two sensors, as shown in **Figure 5**. The first corresponds to a relative pressure transmitter gauge of the water

column which is installed submerged at a depth around two meters under local sounding datum. The second sensor is positioned above the highest expected sea level including the wave contribution, and operates on radar waves emitting pulses which are reflected by the sea surface and received by the transducer of the radar sensor.

The sensors operate on different physical principles, emphasizing accuracy, ease of installation, stability of the datum for its measurements and minimal maintenance required by the radar sensor. Initial test and findings (IOC, 2006. Manual on Sea-Level Measurement and Interpretation. Volume 4) helped us to select a particular manufacturer to incorporate that sensor in the Chilean sea level network.

The primary sea level sensor is a Vegapulse 62 that basically consist of a housing cover on the top with integrated module for displaying measurements and settings, a housing cover with electronics in the main body and a process fitting with flange and horn antenna. This kind of sensor operates in K-band (emitting frequency approx. 26 GHz). The user configurable sampling rate was set at 4 Hz and its measuring accuracy is ± 2 mm. The



Figure 5. Sea level sensors.

connection from the sensor to the QML logger is through an SDI-12 serial/digital interface. The SDI-12 protocol is the standard communications protocol used to transfer the measurements taken by an intelligent sensor to a data recorder.

That sensor usually takes the measurement, makes computations from that measurement, and then outputs the data in engineering units. This type of interface allows battery powered operation that causes minimal current drain, ideal for remote sites operating for long unattended periods. The minimum power supply for this instrument is 15mA, although normal operating mode is around 13.5 mA.

The reference plane for the measuring range is the lower edge of the flange. The maximum range of measuring is 35 m however a different value could be established considering the distance between the extreme of the transducer's horn and the lowest expected sea level. After using this sensor over the last 4 years, the reference plane of measurement has not experienced any significant change, which has been checked during field maintenance campaigns. To avoid false echo a minimum distance of 200 mm between the symmetry axis of the main body and the vertical sea wall must be kept. A false echo learn-feature can be programmed into the sensor, but this is not desirable where the sensor is being used for Tsunami monitoring.

An interesting characteristic of this sensor is the damping option which can be set by using the adjustment module which is very useful in open coast exposed to ocean swell. This feature helps to reduce the signal noise caused by wave action, but should be taken into account as it may generate a variable shift time in phase depending of the damping value used.

The secondary sea level sensor is a submersible relative pressure transmitter which is manufactured by GE Druck model PTX1830 and specifically designed for level and depth measurements in a variety of environments, but the titanium construction makes the devices specially suitable for seawater applications. This sensor operates with a sampling rate of 2 Hz and an operational range from 0 to 10 m of water column was selected, considering that variations of the sea level in the Chilean coast mostly contain an important contribution from tides and tsunamis waves that periodically travel around the Pacific Ocean basin. A tough, vented polyurethane cable is attached to the transducer body, providing a high integrity, waterproof assembly. The cable is strengthened with Kevlar so that there is no measurable elongation when the cable is lowered during installation of the sensor.

The sensor is constructed of all-welded titanium and is backed by a 5-year corrosion warranty. An advanced micromachined silicon piezoresistive pressure sensor provides good performance and accuracy within $\pm 0.10\%$ of the operational tidal range (10 meters) has demonstrated to have a good stability.

Despite the titanium body of the sensor, our field expertise accumulated through the years has found that tightly wrapping of the sensor with rubber sheet and a secondary layer of external electrical tape has avoided any corrosion problem on the external body. This two-layer covering leaves uncovered the tip of the sensor. Additional care should be taken as to not put in contact the external electrical tape directly with the sensor body, as the adhesive used generates aggressive corrosion.

A nose cone, fitted to the extreme of the sensor, prevents damage to the pressure diaphragm but allow fluid flow. The factory default cone, was replaced by a custom made copper cone, which has significantly decreased corrosion problems on the sensor by acting as a sacrificial anode. An additional benefit of this copper cone has been to reduce biofouling problems around or inside the inner pressure chamber, due to the toxic effects of copper on early stages of molusc or crustacea larvae.

To avoid condensation inside the nylon vent tube a Druck sensor termination enclosure designed for field termination of pressure sensors and a Dri-Can Indicating Desiccator that protects from damage caused by moisture or high humidity are used.



GPRS Modem



GOES transmitter



Thrane & Thrane 300 BGAN Antenna

Figure 6. Data transmission devices.

Proper grounding of the sensor to the metal structure of the station has also reduced corrosion and malfunction problems.

Following the described procedures, the typical duration of the submerged pressure sensor is around 18 months of continuous operation with periodical maintenance every 6 months. The radar gauge has not only shown a highly stable measurement over time, but also a high durability in saline environments, without requiring any sensor to be replaced due to external degradation after 5 years of operational use.

○ Telemetry systems

The sea level network is an important component of the National Tsunami Warning System (SNAM), requiring to transmit in real-time the field collected information. For this purpose, every MAWS 110 platform has been equipped with two independent data transmission systems. As primary source GOES satellite system or INMARSAT-BGAN satellite system is used. In turn, as a secondary system most of the stations use GPRS messages (main devices are shown in [Figure 6](#)).

The 40 stations along the coast combine different telemetry configurations in order to achieve a robust communication system. The current array of available configurations is shown in [Figure 7](#).

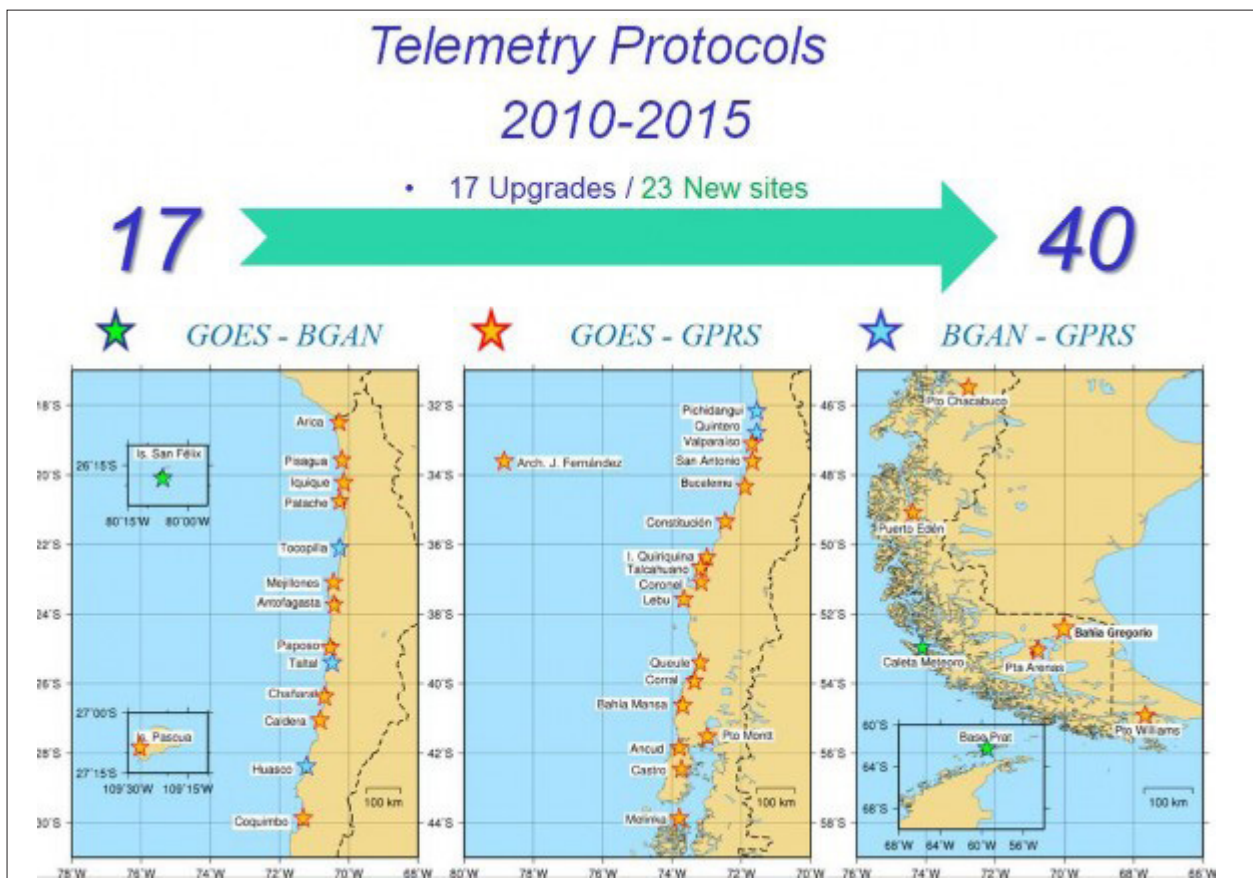

Figure 7. Available data transmission configurations.

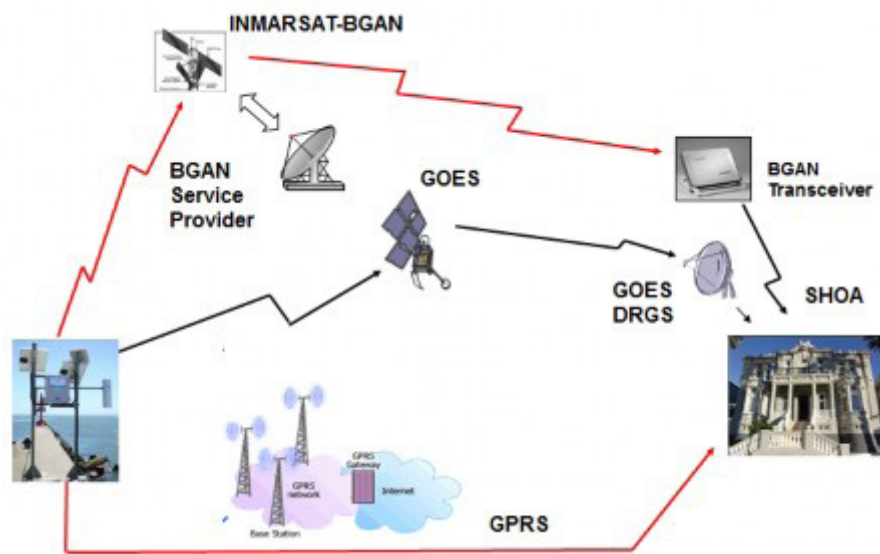

Figure 8. SHOA sea level data acquisition system.

Only 3 stations located in specific remote locations use exclusively satellite data transmission (primary and secondary telemetry system GOES and BGAN respectively) due to lack of GPRS coverage in these areas.

A smaller group of stations (5) transmit data through the Inmarsat BGAN satellite system and GPRS as secondary system. In July 2010, SHOA signed a contract with Globalsat Chile, as provider of the BGAN Managed Solutions, not only providing the service but also optimizing the interface with the sea level platforms. In this group of stations, BGAN terminals manufactured by Thrane & Thrane, model Explorer 300 were used during the first two years, requiring in some cases sporadic attention by the local navy personnel when the satellite connection was lost.

In the last 3 years some of the Explorer 300 Terminals have been upgraded to Hughes 9502 M2M terminals, which main advantages are a stronger gain antenna, reducing the probability of lost link with the satellite, bi-directional communication enabling remote diagnostics and reset from the user. Finally, no manual intervention is required to recover from a lost link with the satellite, due to an integrated IP watchdog that ensure “always-on” network connectivity and complementary an auto-on/auto-context activation, that automatically restores power and PDP connection following loss of power and/or IP connection.

The data transmitted through Inmarsat satellite system is received directly at a BGAN antenna transceiver installed at SHOA’s headquarters. Periodically, the BGAN transceiver

has lost satellite lock and has required a reboot to regain operation. For that reason, a Vaisala iBoot module was installed in support of automating BGAN transceiver reset. The flow of data is shown in [Figure 8](#).

The current BGAN dataflow arrangement ensures a robust communication with the sea level station as it does not rely on data reception at a BGAN/Inmarsat Ground station and internet transfer to the end-user, which is the normal data flow adopted by users of this Network. This may be suitable for scientific applications but not for Tsunami monitoring. The drawback of this philosophy is that it doubles the cost of satellite plans as the user has to pay for data being sent to the satellite as well as data being sent from the satellite to the final receiving antenna.

Most stations have a certified transmitter for GOES satellite system operating at the required speed (300 bps) by the National Environmental Satellite Data and Information Service (NESDIS), an agency of the National Oceanic and Atmospheric Administration (NOAA) of the United States. A Direct Readout Ground Station (DRGS) installed at SHOA’s headquarters allows the direct reception of data from GOES satellites without being dependent on secondary links. This DRGS is already enabled for future upgrade towards 1200 bauds GOES transmitter.

The data is transmitted through GOES system at typical intervals of 5 minutes, although 10 and 15 minutes interval is used in a couple of stations located in inners waters. Those stations with GPRS as secondary telemetry system transmit data every 5 minutes with a 10 minute

window of overlapping. When a BGAN antenna is installed, the DCP is programmed to transmit the data through this system every 1 minute using a 1 minute window of overlapping.

○ Data processing

To manage the large volume of data from the sea level network, some software was developed. Metman data server designed by Vaisala, allows to display graphs of single or multiple stations and also offers the option to view statistics from individual stations during a specified time which is calculated on a daily basis. In this way, the performance of every telemetry system can be inspected.

A common period of 7 days starting on April 3rd 2015 and specific stations located along the Chilean coast were selected. In the tables values under 95% of availability are highlighted and **Figures 9-11** show graphs of examples of data availability of the telemetry systems used.

By analyzing the tables and graphs below, clearly the most reliable systems are in decreasing order Inmarsat BGAN, GPRS and GOES, highlighting the high percentage

that show the BGAN system, with virtually 100% data reception for the whole group of 8 stations using this telemetry system on the coast of Chile.

GPRS is another reliable system, which also shows 100% data reception in most stations, over the one week period examined. In this case the overall percentage has decreased due to recurrent problems of data transmission in the town of Tocopilla (Latitude: 22° 06' S; Longitude: 70° 14' W), which is associated to antenna's infrastructure installed in that city located in the north of Chile.

By the time of this new upgrade of the BGAN network, GOES data transmission performance showed usually high values of data availability. However, in the last couple of years, this telemetry system has experimented some troubles associated to solar storms which generate atmospheric interferences that affects satellite transmission, in particular in mid southern latitudes.

Installing redundant sea level sensor and satellite telemetry demand a higher power supply to operate the station. In some places, main electrical power is not available and solar panels are the only source of power to charge the battery for ensuring continuous operation

Station	2015-04-03		2015-04-04		2015-04-05		2015-04-06		2015-04-07		2015-04-08		2015-04-09	
ARI_GOES	1319	92 %	1367	95 %	1387	96 %	1279	89 %	1350	94 %	1269	88 %	707	87 %
CAL_GOES	1384	96 %	1286	89 %	1365	95 %	1274	88 %	1186	82 %	1220	85 %	753	93 %
VLP_GOES	1354	94 %	1335	93 %	1408	98 %	1364	95 %	1345	93 %	1349	94 %	770	95 %
CST_GOES	1384	96 %	1390	97 %	1429	99 %	1299	90 %	1335	93 %	1294	90 %	771	95 %
EDN_GOES	1334	93 %	1260	88 %	1394	97 %	1304	91 %	1230	85 %	1214	84 %	744	92 %
Sum/Average	6775	94 %	6638	92 %	6983	97 %	6520	91 %	6446	90 %	6346	88 %	3745	93 %

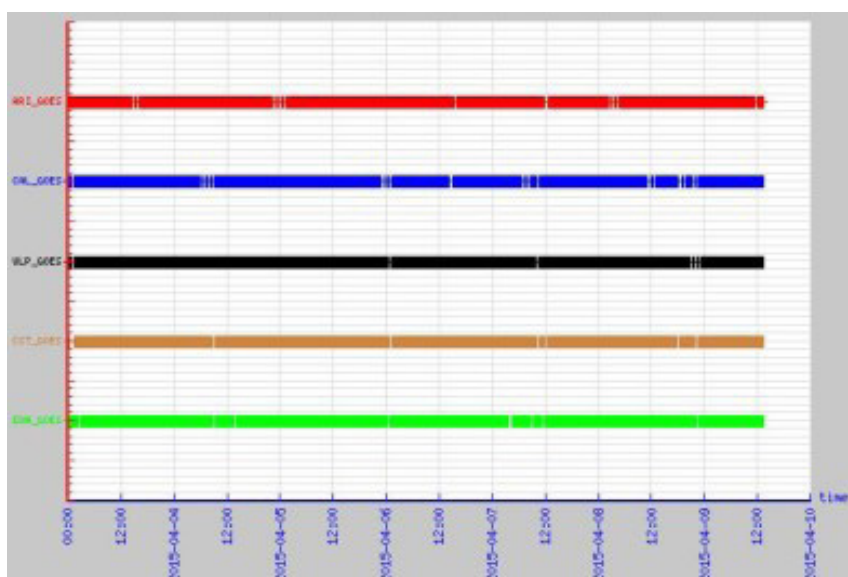

Figure 9. Data availability transmitted through GOES satellite system.

Station	2015-04-03		2015-04-04		2015-04-05		2015-04-06		2015-04-07		2015-04-08		2015-04-09 !	
HUA_BGAN	1434	100 %	1440	100 %	1440	100 %	1440	100 %	1436	100 %	1435	100 %	796	100 %
PIC_BGAN	1433	100 %	1436	100 %	1440	100 %	1440	100 %	1440	100 %	1440	100 %	796	100 %
TAL_BGAN	1432	99 %	1440	100 %	1437	100 %	1440	100 %	1440	100 %	1440	100 %	796	100 %
TOC_BGAN	1432	99 %	1440	100 %	1440	100 %	1440	100 %	1440	100 %	1440	100 %	794	99 %
QUL_BGAN	1431	99 %	1440	100 %	1436	100 %	1440	100 %	1436	100 %	1437	100 %	796	100 %
PRT_BGAN	1433	100 %	1440	100 %	1440	100 %	1439	100 %	1440	100 %	1419	99 %	795	99 %
MET_BGAN	1433	100 %	1440	100 %	1440	100 %	1440	100 %	1439	100 %	1440	100 %	794	99 %
SFX_BGAN	1436	100 %	1435	100 %	1436	100 %	1436	100 %	1436	100 %	1437	100 %	790	99 %
Sum/Average	11464	100 %	11511	100 %	11509	100 %	11515	100 %	11507	100 %	11488	100 %	6357	99 %

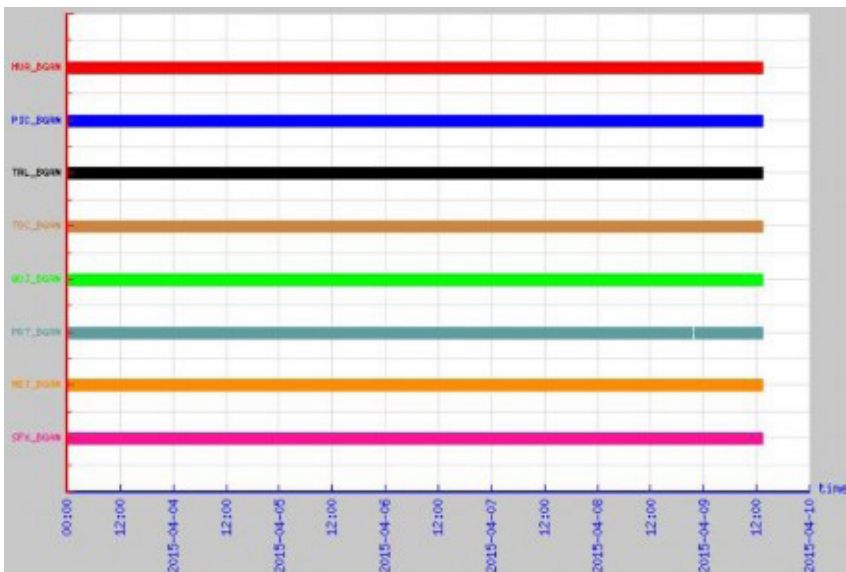

Figure 10. Data availability transmitted through INMARSAT-BGAN satellite system.

Station	2015-04-03		2015-04-04		2015-04-05		2015-04-06		2015-04-07		2015-04-08		2015-04-09 !	
HUA_GPRS	1440	100 %	1440	100 %	1440	100 %	1440	100 %	1440	100 %	1440	100 %	805	100 %
PIC_GPRS	1440	100 %	1440	100 %	1440	100 %	1440	100 %	1440	100 %	1440	100 %	806	100 %
TAL_GPRS	1440	100 %	1440	100 %	1440	100 %	1440	100 %	1440	100 %	1195	83 %	805	100 %
TOC_GPRS	1324	92 %	1046	73 %	545	38 %	437	30 %	1319	92 %	1284	89 %	738	92 %
QUL_GPRS	1440	100 %	1440	100 %	1440	100 %	1440	100 %	1440	100 %	1440	100 %	805	100 %
Sum/Average	7084	98 %	6806	95 %	6305	88 %	6197	86 %	7079	98 %	6799	94 %	3959	98 %

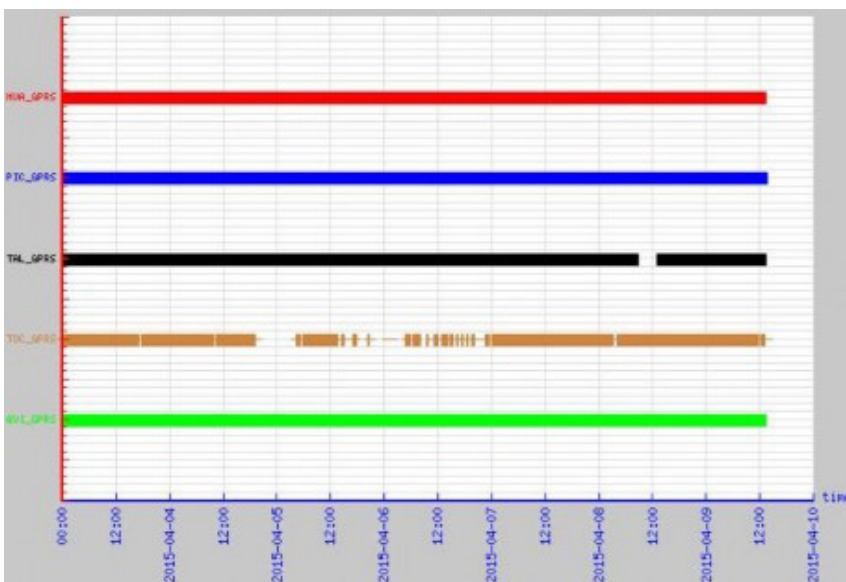

Figure 11. Data availability transmitted through GPRS telemetry system.

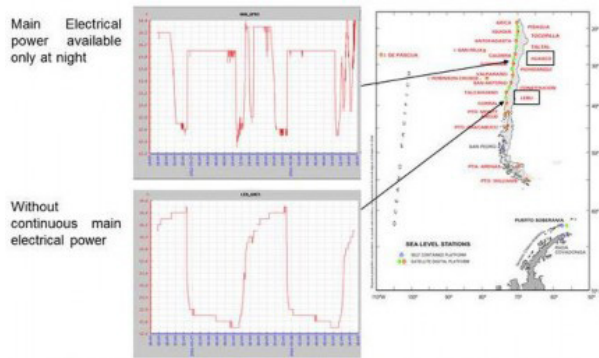

Figure 12. Power supply and operating voltage in new stations.

of the station. In this case two 50 Watt solar panels are usually installed. In Figure 12, upper left graph shows how the voltage changes during a period of two days in the station of Huasco (Latitude: 28° 28' S; Longitude: 71° 14' W) which transmit the data through BGAN and GPRS systems. During the night, main AC power is shown as a steady plateau.

The bottom left graph shows the voltage changes at the station of Lebu (Latitude: 37° 37' S; Longitude: 73° 41' W), where main AC power is not available and station relies on its photovoltaic system, with solar panel powering the station during the day and batteries during the night. This system is only suitable for GOES/GPRS telemetry configuration as BGAN telemetry requires AC power for a normal operation thru the night. In this case the lack of AC power will interrupt communications if not restored within two days.

○ Data comparison

Several studies carried out since 2002 onwards, have shown the advantages of using radar sensors to measure sea level, however it is important to demonstrate how this sensor has performed during operation in ports exposed to different wave conditions on the coast of

Chile. Nautical charts sectors of every place chosen are shown in Figure 13 where the location of sea level stations and how open is the area to wave regime influence is displayed.

Comparisons of hourly data selected from the 1 minute raw data collected during 2014 by the radar and pressure sensors in the ports of Valparaíso (Latitude: 33° 02' S; Longitude: 71° 38' W), Constitución (Latitude: 35° 20' S; Longitude: 72° 25' W) and Talcahuano (Latitude: 36° 41' S; Longitude: 73° 06' W) were made (Figure 14-16). Every time series was referred to its mean value and the lag time between them was found. Once they were synchronized the residuals were calculated as pressure minus radar.

Table 1. Root Mean Square (cm) of hourly residuals

Month	Locality		
	Valparaíso	Constitución	Talcahuano
Jan	2,8	5,3	1,5
Feb	2,0	4,6	1,1
Mar	2,7	5,4	1,1
Apr	3,1	5,9	1,2
May	3,7	8,5	1,8
Jun	4,1	10,5	1,5
Jul	4,1	11,0	1,6
Aug	3,1	10,9	1,4
Sep	3,8	8,9	1,4
Oct	2,9	6,7	4,0
Nov	2,8	5,6	3,5
Dec	2,9	5,5	1,3

Talcahuano is a protected port within Concepcion Bay harbor, so that the attenuation suffered by the train of waves from the Pacific Ocean, is reflected in the smaller magnitude of the RMS values of residuals comparatively lower than those obtained in a port fully exposed to the waves as Constitución. Meanwhile the sea level station



Figure 13. Locations of sea level stations (▲)

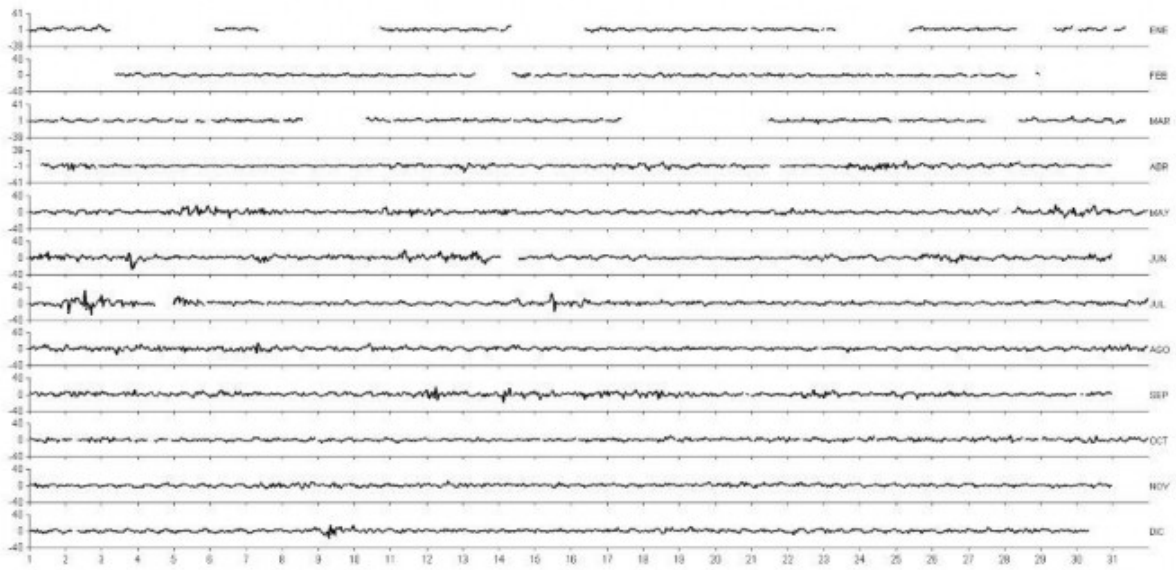

Figure 14. Valparaiso 2014 Hourly residuals.

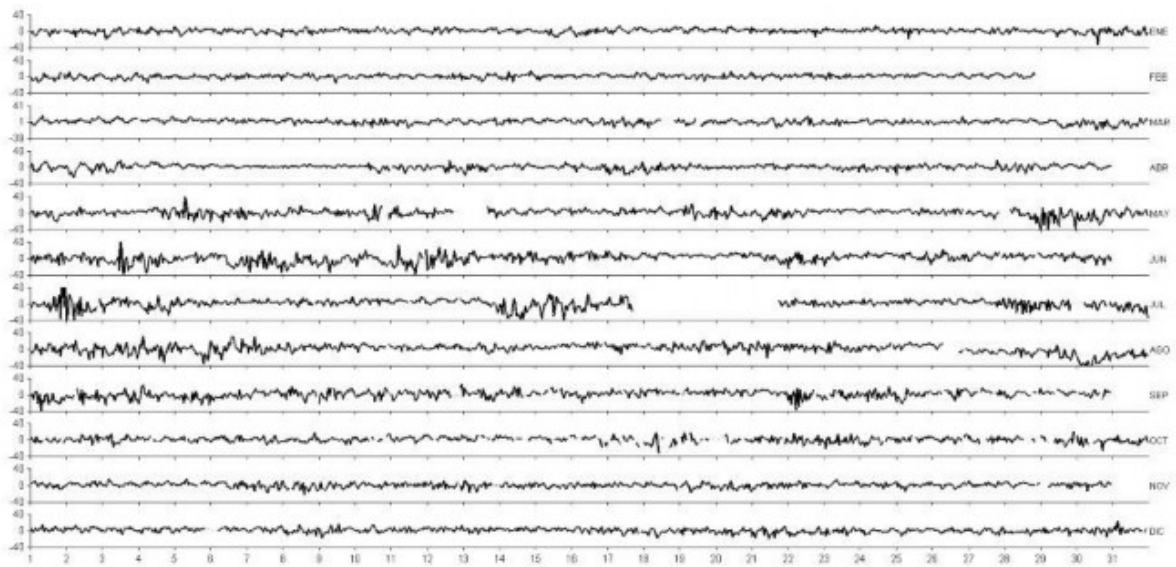

Figure 15. Constitucion 2014 Hourly residuals.

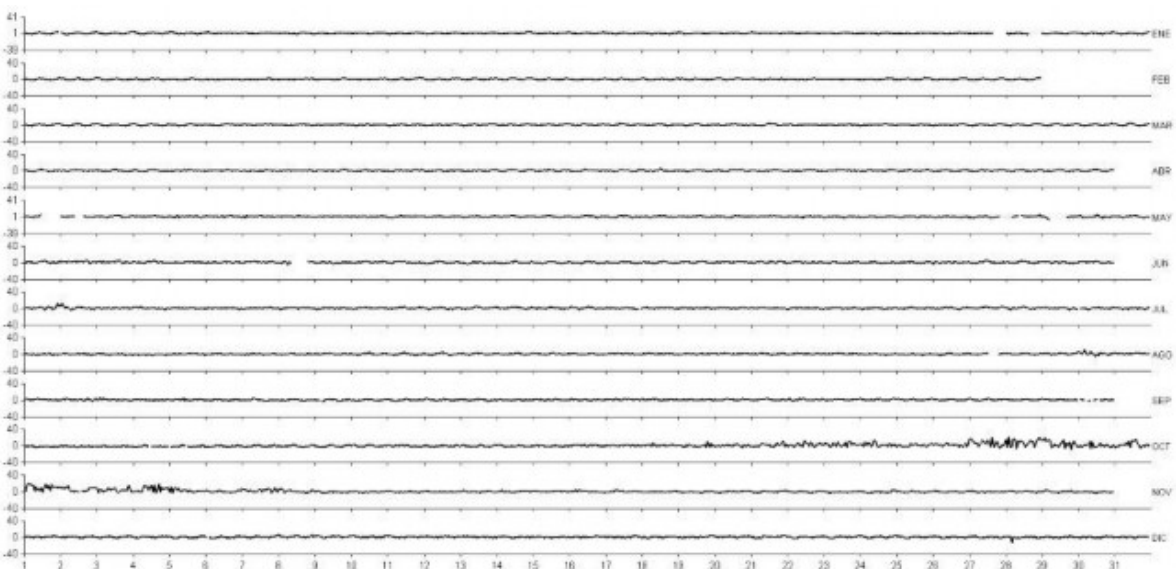

Figure 16. Talcahuano 2014 Hourly residuals.

of Valparaiso is located in a protected sector of the breakwater built to protect the port sites. The variability of monthly RMS values is conditioned by the climatology of waves through the year of each particular place along the coast.

To inspect how the values of both sensors fit, a common period of two days was selected in every place. First, raw data and residuals are shown and later a moving-average low-pass filter (15 minutes window) was used generating more smoothed time series. Finally, in every place a

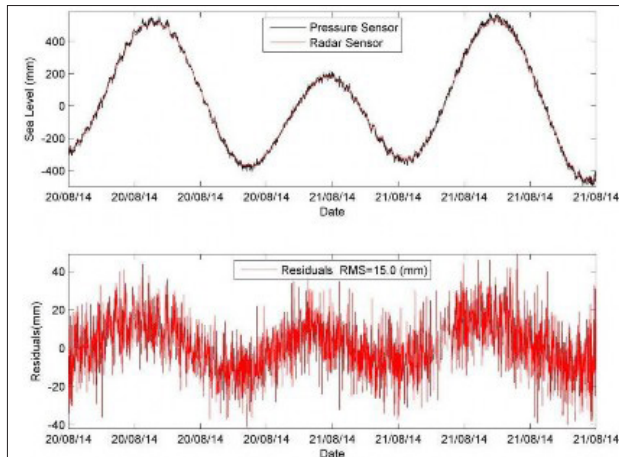

Figure 17. Valparaiso Raw time series and residuals 20th and 21th August 2014.

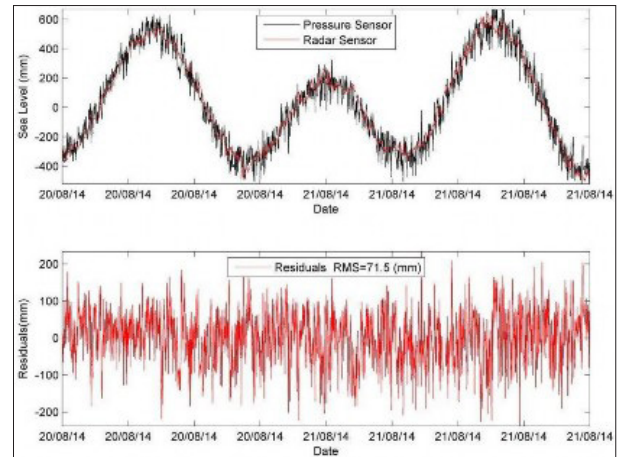

Figure 20. Constitucion Raw time series and residuals 20th and 21th August 2014.

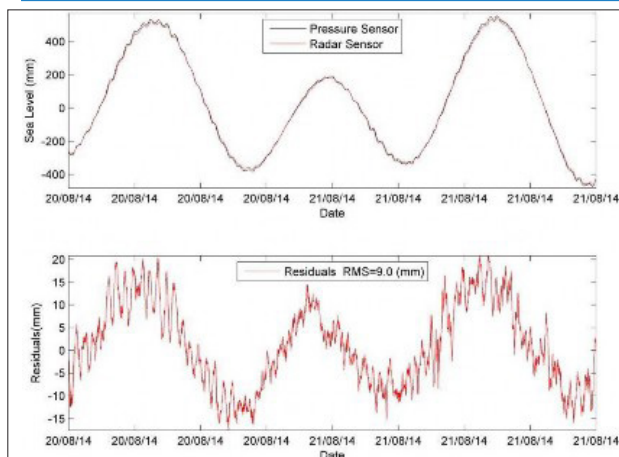

Figure 18. Valparaiso Filtered time series and residuals 20th and 21th August 2014.

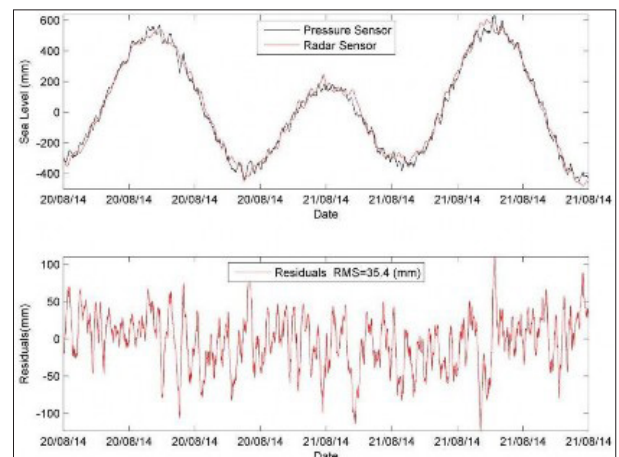

Figure 21. Constitucion Filtered time series and residuals 20th and 21th August 2014.

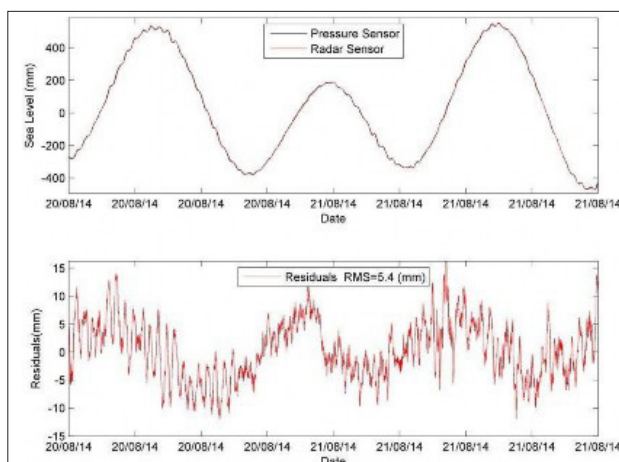

Figure 19. Valparaiso Radar range adjust and residuals 20th and 21th August 2014. (factor 1.025)

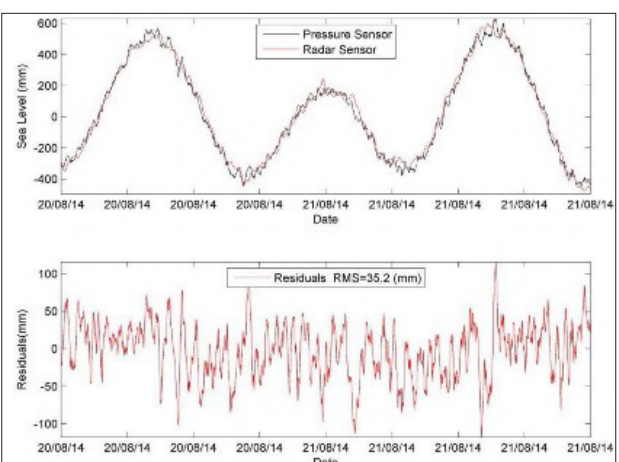

Figure 22. Constitucion Radar range adjust and residuals 20th and 21th August 2014. (factor 0.99)

factor was applied to the smoothed radar time series in order to obtain the minimum RMS of residuals. The three analyzed sites showed an increasing adjustment (decreasing RMS) after applying the mentioned methods (Figures 17-25).

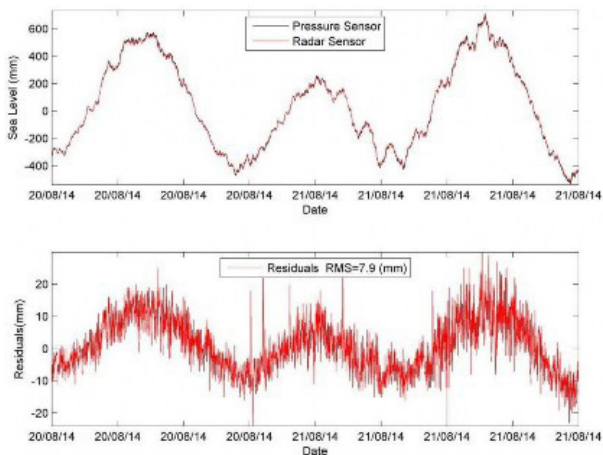

Figure 23. Talcahuano Raw time series and residuals 20th and 21th August 2014.

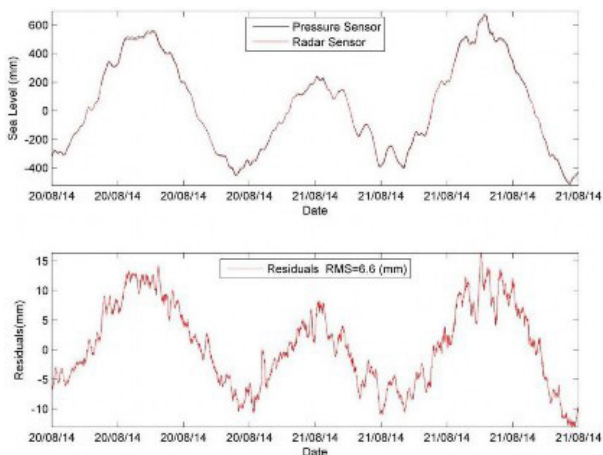

Figure 24. Talcahuano Filtered time series and residuals 20th and 21th August 2014.

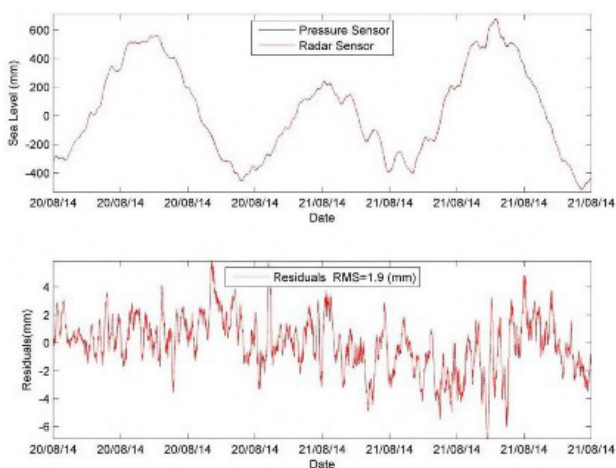

Figure 25. Talcahuano Radar range adjust and residuals 20th and 21th August 2014. (factor 1.021)

The original data, clearly shows the high frequency oscillations (noise) due to the wave regime in the area, which is particularly relevant at Constitution site given its open coast location. This is not so evident at Talcahuano site, which is more protected from wave action. The high frequency noise is more evident on the pressure sensor than on the radar, due to the 2 s damping. The strong wave regime experienced at Constitution site, required to set a 100 s damping to achieve a usable sea level data.

After using filters to eliminate the noise caused by the waves, we achieved a good fitting between both sensors on those sites more protected from the wave action, achieving RMS values of 9.0 mm at Valparaiso and 6.6 mm at Talcahuano. These values are lower than those determined by other groups (Martín Míguez et al., 2005) with similar comparisons between radar and bubbler sensors with RMS fluctuating between 10 to 16 mm. Comparisons with other technologies achieved results between 7 to 19 mm.

Seiche signal are particularly strong at Talcahuano site, which can be accurately detected without any phase lag or shift time compared to the pressure sensor.

The RMS values increases to 35.4 mm at Constitution, showing a lower adjustment between pressure and radar sensor sea level data. The results obtained at protected sites reflect the reliability of this sensor, but it should be used with caution at sites exposed to wave action if the data are to be used for scientific purposes.

The residuals calculated for Valparaiso and Talcahuano showed that the radar sensor measured a tidal range slightly lower than the one detected by the pressure sensor. The differences were about 20 mm at Valparaiso, 10 mm at Talcahuano but without any conclusive results at Constitution where the tidal range measured by the radar is slightly higher.

These differences were consistent with the results found after using radar sensor Waterlog H-3611 (Heitsenrether et al., 2011).

○ Conclusions

Over the last 5 years, the Chilean Sea Level Network underwent a complete upgrade increasing the number of sea level stations along the coast. Coupled to this, the addition of more robust communication configurations and the adoption of radar as secondary sea level sensor have increased the operational capabilities of the National Tsunami Warning System.

The Vegapulse 62, chosen as secondary sensor using a SDI-12 interfaces specially suited for operations at remotes sites given its low power requirement. The adoption of any particular telemetry option should also take this factor into account.

By comparing time series of hourly sea level data measured during the year 2014 by the pressure and radar sensor, the residuals RMS calculated was particularly lower on areas protected from the wave regime.

○ References

- Heitsenrether, R. and Davis, E. 2011. Test and evaluation report. Limited acceptance of the Design Analysis WaterLog H-3611i microwave radar water level sensor. NOAA Technical Report NOS CO-OPS 061.
- IOC, 2006. Manual on Sea-Level Measurement and Interpretation. Volume 4: An Update to 2006. Intergovernmental Oceanographic Commission Manuals and Guides No. 14. Paris: UNESCO/Intergovernmental Oceanographic Commission.
- Martín Míguez, B., Pérez Gómez, B. and Álvarez Fanjul, E. 2005. The ESEAS-RI sea level test station: Reliability and accuracy of different tide gauges. *International Hydrographic Review*, 6, 1. 2-11.

Experience with Radar Gauges at SHOM (France)

Gaël André¹, Noé Poffa¹, Guillaume Voineson¹, Vincent Donato¹,
Séverine Enet¹, and Laurent Testut²

¹ SHOM, 13 rue Chatellier, CS92803, 29228 Brest Cedex 2, France

² LEGOS/OMP, 14 av. Edouard Belin, 31400 Toulouse

Contact person: V. Donato

E-mail: vincent.donato@shom.fr

○ Introduction

In the last few decades considerable progress has been made in the modernization of tide gauge networks. This progress originally arose out of research purposes, in particular storm surges, tsunami monitoring and climatic related sea level changes. During this period new observation technologies became available. Traditional mechanical float devices have progressively been replaced by electronic and digital ones, mainly based either on the measurement of the subsurface pressure or on the measurement of the time of flight of a (radar or acoustic) pulse. Comparison experiments on pressure, acoustic and radar gauges were undertaken, through in situ or laboratory experiments, in order to assess the accuracy, precision and instrumental stability of these emerging technologies, but also to compare their cost, ease of installation and use (Woodworth and Smith, 2003; Martín Míguez et al., 2005; Martín Míguez et al., 2008b; Blasi, 2008). Radar tides gauges, in particular, stood out as a promising option in terms of accuracy, stability and ease of operation (Martín Míguez et al., 2008a). As a result, this technology was early recommended by the GLOSS program and has been chosen by many national operators to upgrade their networks (Woodworth et al., 2007, 2009; Martín Míguez et al., 2008a).

The RONIM tide gauge network

Description

Since 1992 and the launch of the French sea level observation network (RONIM), SHOM has installed, modernized and densified its network of digital coastal tide gauges. The upgrade of its network, linked both to technological advances in the field of level sensors and data transmission capability, was carried out in several stages. The RONIM tide gauges network is designed to produce accurate and continuous time series on a long term basis. The data acquired by tide gauges (water depth and atmospheric pressure) are collected by SHOM and made available to other organizations through its data portal REFMAR (<http://refmar.shom.fr/>). They thus meet many needs such as navigation, tide prediction, mean sea level changes, extreme levels statistics, storm surges, tsunami warning and calibration of satellite radar altimeters, etc.... SHOM has also been responsible for the installation of tide gauges in New Caledonia, Wallis and Futuna, and French Polynesia in collaboration with local authorities and universities. Data from these tide gauges



Figure 1. Location of the RONIM operational tide gauge stations in mainland France

is transmitted in real time to tsunami warning centers in the Pacific.

In 2016 RONIM network is composed of 39 stations in mainland France (**Figure 1**) and 8 overseas stations, namely Numbo (New Caledonia), Fort-de-France (Martinique), Pointe-à-Pitre (Guadeloupe), Saint-Pierre (Saint-Pierre-et-Miquelon Islands), Pointe des Galets and Sainte Marie (La Réunion), Dzaoudzi (Mayotte) and Iles du Salut (French Guyana).

The RONIM network meets the national and international requirements related to sea level monitoring. This involves the acquisition of high quality sea level data that must then be made available to end users. Ensuring the quality of the sea level data is not an easy task. The performance of the tide gauges has to be guaranteed under wide tidal ranges up to 14m and harsh weather conditions, which is the case for most of the stations located on the northern coast of France. The station characteristics may vary depending upon the site, but all of them are conceived to fulfill the requirements specified by French standards (SHOM, 2005), which are compatible with the Global Sea Level Observing System (GLOSS) program (IOC, 1997, 2002 and 2006).

Keeping up with technological innovations has led SHOM to gradually replace its acoustic tide gauges with radar tide gauges, beginning with the Atlantic harbors. The first radar sensor was installed in Le Havre in October 1998, and currently all the tide gauge stations use radar technology. Hereafter we will focus on this type of sensor, which is likely to be used for the upgrading of many tide gauge networks in the near future (IOC, 2005).

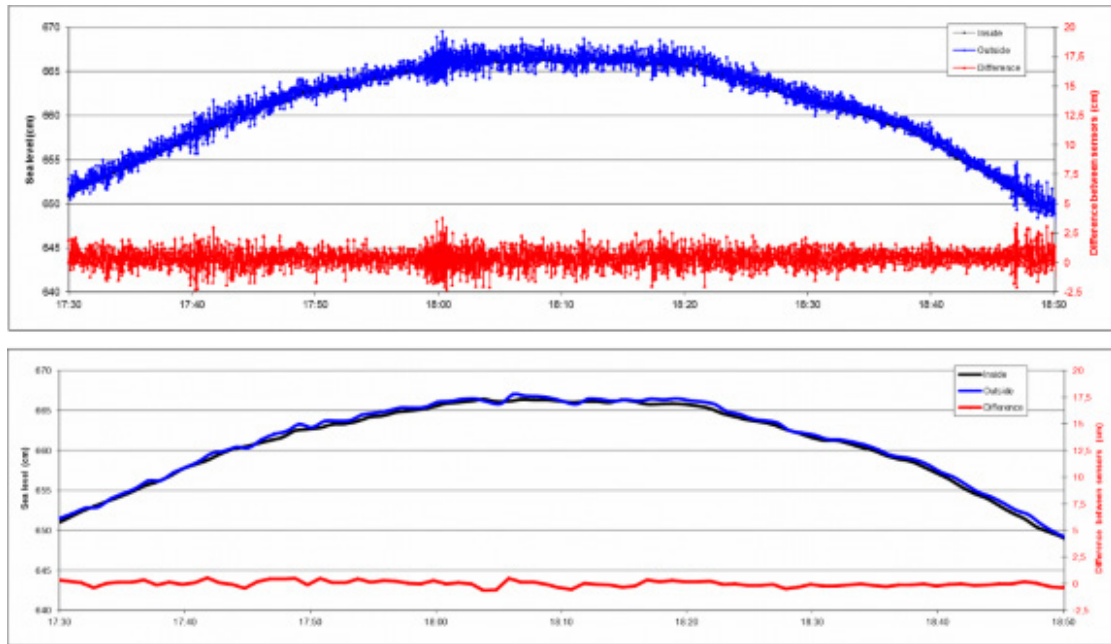

Figure 2. Comparison at Brest tide gauge between radar measurements inside and outside the stilling well using 1s data (above – black curve is hidden under the noisy blue one) and 15s averaged data (below)

Sensor technology

The choice of the radar technology for measuring the sea level has been made at the expense of floating, pressure or ultrasonic systems for reasons of accuracy and stability, ease of installation and low maintenance required (Le Roy 2006). Moreover, installing radar sensors in open air has been made possible thanks to numerical averaging that has replaced the traditional stilling well mechanical filtering (Figure 2). It is also justified by the need not only to measure the tide or the average level, but also higher-frequency phenomena, such as coastal seiches, storm surges or tsunamis, for which the traditional stilling wells may be less suitable. For those purposes, RONIM tide gauges are computing one sea level value every minute averaging fifteen consecutive 1s measurements instead of the traditional 10 minute data averaged on 2 minutes used for hydrographic purposes. 15s averaging allows filtering the choppy sea surfaces as shown for Brest site on Figure 2. However, under bad weather conditions, it is still difficult to determine where the sea level surface without extra-filtering is.

Currently, SHOM operates Optiwave FMCW and Optiflex TDR radar sensors manufactured by Krohne (<http://krohne.com/>) which exist in a marine stainless steel version that is recommended for outside installations. Those sensors are configured to acquire 1 raw measurement every second that are then averaged by the data logger over a period that depends on the final purpose (15s for high frequency phenomena, 2 minutes for hydrographic applications).

Optiwave sensors need less maintenance because it has no contact with the water surface and can be installed in open air (Figure 3). Nevertheless, when instrumenting an existing stilling well, there can be some multipath effects or false detections due to metal pieces inside or around the well. In that case, it is recommended to use Optiflex sensors which has a weighted wire that guide the radar wave along the stilling well avoiding multipath issues (Figure 3). The wire needs to be cleaned regularly as concretions along the bottom part can delay the wave and false the value in a way that it is difficult to detect in the data. In the same way, the wire can sometimes lose its weight and affect the values although the wire is quite rigid.

An alternative that SHOM has tested in a well is to install non-contact Optiwave sensor on the top of a stainless steel tube (diameter of around 8cm) that serve both as stilling well and wave guide (Figure 4). As for floating tide gauge, the bottom end is conical to have a better filtering (see IOC 2006).

Krohne sensors are then able to proceed to a spectrum analysis at very low tide that is memorized to kill false echoes due to the environment. To use this tool, it is important that the sensor is used via its digital output. At SHOM, we use the HART Protocol available for Krohne sensors. In particular, it has been noticed that numerical output avoid drifting issues that affect the usual analog outputs because of electronic components sensitivity to environment.

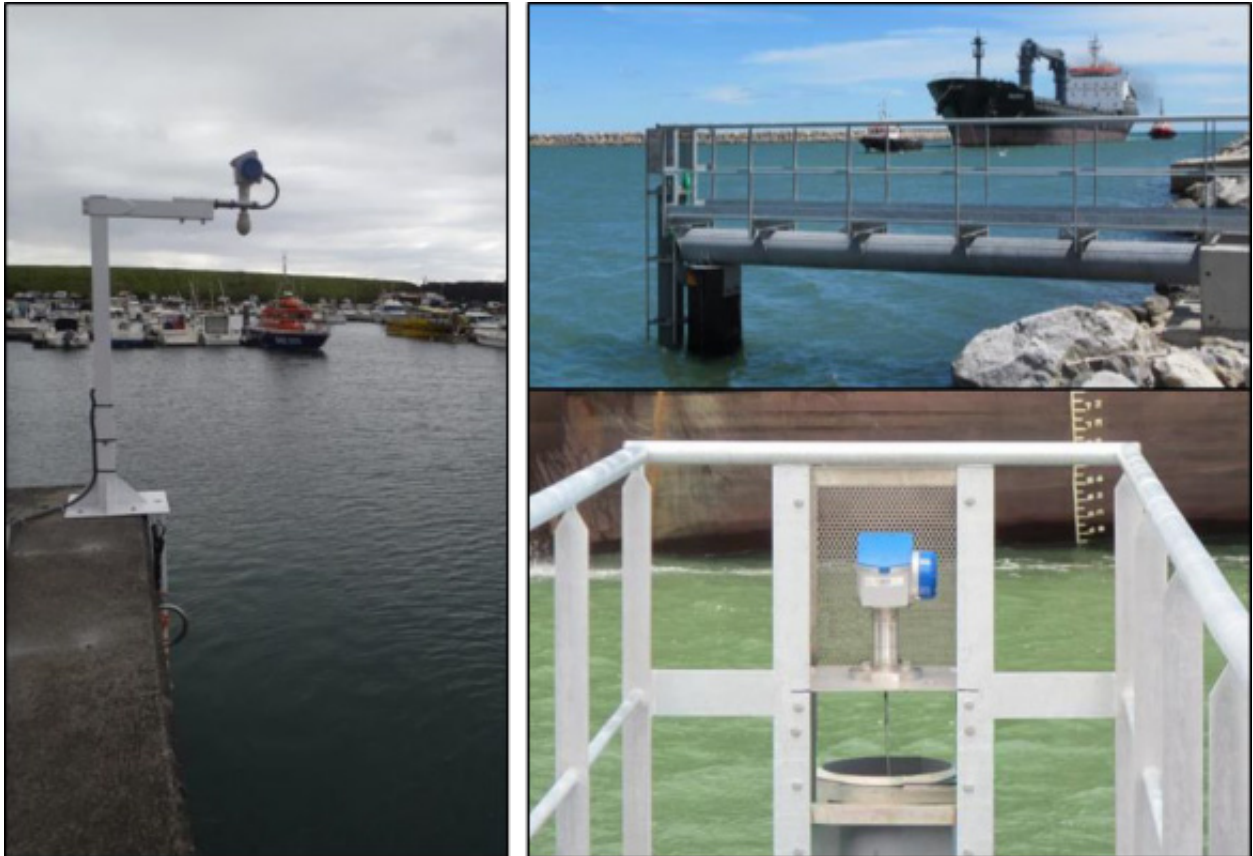

Figure 3. Examples of RONIM tide gauge installations : Optiwave mounted in open air at La Réunion (left) and Optiflex mounted in a PVC stilling well at Port-La-Nouvelle (right).



Figure 4. Example of RONIM tide gauge installation. Optiwave mounted in stainless steel stilling well at Fos-sur-Mer (right).

Working with so called “intelligent” sensors still has to be investigated to explore how much real time data treatment can be done by the sensor itself without truncating the water level measurement and its timestamp.

Real-Time transmission

Since 2006 and the installation of a real-time Internet connection at Brest tide gauge, SHOM has equipped gradually all RONIM sites. The data transmitted over the Internet is redistributed by SHOM to various web portals such as the IOC Sea Level Station Monitoring Facility (<http://www.ioc-sealevelmonitoring.org/>) and the French portals REFMAR (<http://refmar.shom.fr/>) for high frequency data and SONEL (<http://www.sonel.org/>) for the mean sea levels. RONIM data also contributes to European ocean monitoring programs such as EuroGOOS or MyOcean. Real-time data are also open to the tsunami warning centers around Mediterranean Sea and NorthEast Atlantic, Indian Ocean and Caribbean Sea. Internet transmission is performed by ADSL (Asymmetric Digital Subscriber Line) on the conventional phone network or by GPRS (General Packet Radio System) mobile networks. The choice of land or mobile transmission is based on the networks availability on site and local support from partner’s infrastructures. SHOM has noticed that GPRS has a lower transmission rate in general, in particular during summer when mobile network may be overloaded by tourists. In some place where ADSL connection was not available near the sensor, HF transmissions have been developed to transmit the data between the sensor and a distant datalogger.

To support the operational coastal hazard warning systems, Internet transmissions have been backed up by an independent satellite transmission through the Global Telecommunication System (GTS) of the World Meteorological Organization (WMO). 1 minute data are transmitted every 6 minutes to the Meteosat geostationary satellite of the European organization EUMETSAT. The messages are transmitted in a CREX format defined by the WMO and redistributed on the GTS and are thus available to the accredited agencies.

Co-located GPS

Tide gauges measure sea level relative to the Chart Datum defined by a reference point attached to the land upon which the gauges are grounded at the coast. The tide gauge measurements are thus related to the ground that can have its proper slow vertical movements in an

absolute reference system. A permanent co-located GPS antenna can measure those ground movements. The GPS antenna needs to be levelled to the reference point so that the sea level data can be referenced in the absolute geodetic reference systems. Such data are used for mean sea level studies and also to calibrate satellite altimeters.

In the frame of the French SONEL program (<http://www.sonel.org/>), several permanent GPS antennas have been installed on the main RONIM station. In 2016, 19 tide gauges are co-located with a permanent GPS station: Dunkerque, Dieppe, Ouistreham, Cherbourg, Saint-Malo, Roscoff, Brest, La Rochelle, l’Île d’Aix, Saint-Jean-de-Luz, Sète, Marseille, Ajaccio, Pointe-à-Pitre, Fort-de-France, Guyane, Mayotte, Nouméa and Saint-Pierre-et-Miquelon. Efforts will continue in the coming years to generalize these installations.

○ The radar technology assessment

Since the establishment of the RONIM network, SHOM has been associated with many programs aiming at observing long term sea level changes (GLOSS, ESEAS, SONEL), forecasting (PREVIMER), supporting French national storm surges and strong waves warning system (VVS) and also tsunami warning systems in several oceans: Indian Ocean (IOTWMS), Caribbean (CARIBE-EWS), Pacific (PTWS), Northeast Atlantic and Mediterranean (NEAMTWS). This is especially through these new operational programs that recent instrumental developments of real time digital coastal tide gauges have been done.

Since 2010 SHOM has been formerly given a normative and coordinating role on tide gauges observations (<http://refmar.shom.fr/>). One of its missions is therefore to advise the various sea level data producers in France on measurement best practice and on state of the art tide gauge technology. Within the “Groupe de Recherche de Géodésie Spatiale” (GRGS), SHOM also takes part in a broad study of tide gauges error characterization.

Experiment set-up

A set of different tide gauges acquired with a CNRS grant has been installed mid-2012 at the historic Brest-Penfeld tide observatory in addition to the existing radar gauge. This site offers a good working environment for the installation and study of the sea level measuring equipment. Six tide gauges using different technologies, such as differential pressure, pulse radar and Frequency



Figure 5. View of sea-level instruments used in this study.

Modulated Continuous Wave (FMCW) radar, have been deployed for a long term (over a year) comparative study of the different systems.

The choice of radar sensors was justified by the fact that radars are now starting to be the new standard for permanent automated tide stations throughout the world. In fact, some of those sensors have already been compared in previous studies (Blasi, 2008; Boon et al., 2009, Martín Míguez et al., 2012). Moreover, pressure sensors are the most developed sensors for temporary tide measurements and are generally installed as a secondary sensor on permanent stations. It is therefore interesting to include both technologies in the comparative study.

A particular feature of the Brest site is its stilling well. Sensors were installed inside and outside, depending on their characteristics (Figure 5). Open air radars were deployed outside and pressure sensors both inside and

outside the stilling well in order to characterize their ability to respond to sea surface variations whether still or agitated.

All sensors, 4 radars and 2 pressure gauges were deployed since summer 2012. Their characteristics are described in Table 1. All data loggers were synchronized in UTC using a GPS receiver. The existing waveguided BM100 radar sensor inside the stilling well was used as the reference. Installed since 2003, this tide gauge was considered the best standard available as it is calibrated following SHOM procedures and regularly checked on its full tidal range.

The high sampling rate of tide gauges (Table 1) makes it possible to study high frequency oscillations such as seiches and waves. The deployment period was from the 21 February 2013 to the 18 March 2013.

Methodology

Van de Casteele diagrams (hereafter VDC) is a simple test that allow characterizing the systematic errors in the tide gauge system. This procedure was devised in the 1960s and is commonly used by SHOM and other operators in France (Martín Míguez et al., 2008b). This test consists of a simple diagram in which the sea level elevation is plotted against the gauge error determined as the difference in sea level height measured by the tide gauge and the reference one. The main types of error that can be identified using this test is the time shift between the clocks of both instruments reflected in an hysteresis features (ellipsoidal shape) in the diagram and scale error reflected in a slope of the diagram which appears when two instruments are measuring different tide ranges.

Data comparison

One of the main concerns in data comparison was to determine the sampling frequency at which to acquire the measurements. High frequency (1Hz for Miros, Optiflex, Optiwave and Keller) was necessary to evaluate the ability of sensors to measure small and rapid variations of the sea surface while also characterizing sensor noise. Campbell CS455 and CS476 acquisition period was set at its minimum that is 5s. This also meant

Table 1. Sensors characteristics

Sensor	Krohne BM100	Miros RangeFinder SM-140	Krohne Optiwave	Campbell CS455	Campbell CS476	Keller PR-36XW
Technology	Pulsed radar	FMCW	FMCW radar	Differential pressure	Pulsed radar	Differential pressure
Stilling well	Inside	Outside	Outside	Inside	Outside	Outside

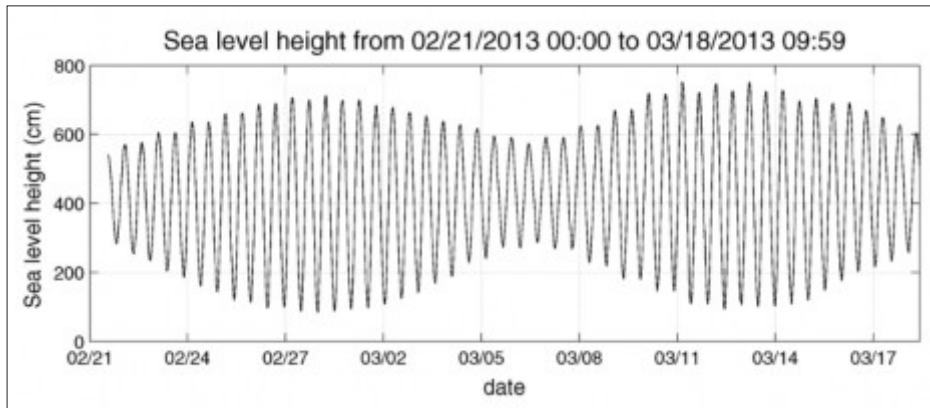

Figure 6. Sea level heights measured with the BM100 radar sensor.

a large amount of data to consider in post-treatment. Using a lower sampling frequency and a low pass filter in order to smooth out the data, allow for a comparison of all sensors inside and outside the stilling well with a similar noise level. The considered period in this study extends from the 21st February to 18th March 2013. This period presents two cycles with spring high tide amplitudes (Figure 6).

The high frequency sea level oscillations are computed from the raw sea level heights using a Butterworth high-passed filter with a 2 hour cut off frequency. Oscillations are clearly visible for each sensor (Figure 7).

Results

First of all, the results show that all sensors show differences between them that do not exceed few centimeters provided good calibration which is applied

to avoid systematic errors. In particular, standard deviations between radar sensors do not exceed 0.5 cm.

On Figure 7, it logically appears that tide gauges deployed outside the stilling well are noisier except for Keller and CS476. For the CS476, this can be explained by the 5s acquisition period that may include a slight analog integration of the signal. Bottom pressure sensors (as for Keller) are less sensitive to the high frequency surface wave environment as they damp this signal according to their depth.

It also shows that Krohne and Miros sensors are able to catch very high frequency oscillations. Indeed, it is difficult to differentiate high frequency waves from noise, but comparisons between Optiwave and Miros sensors show a good correlation with a standard deviation of 0.09cm (Figure 8).

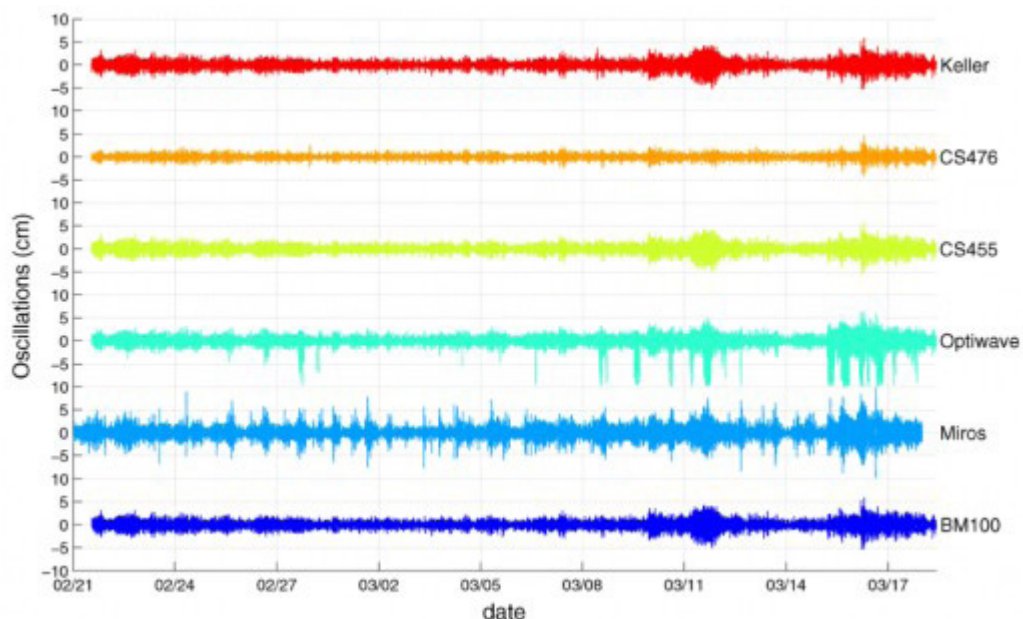

Figure 7. High frequency part of the sea level measurements.

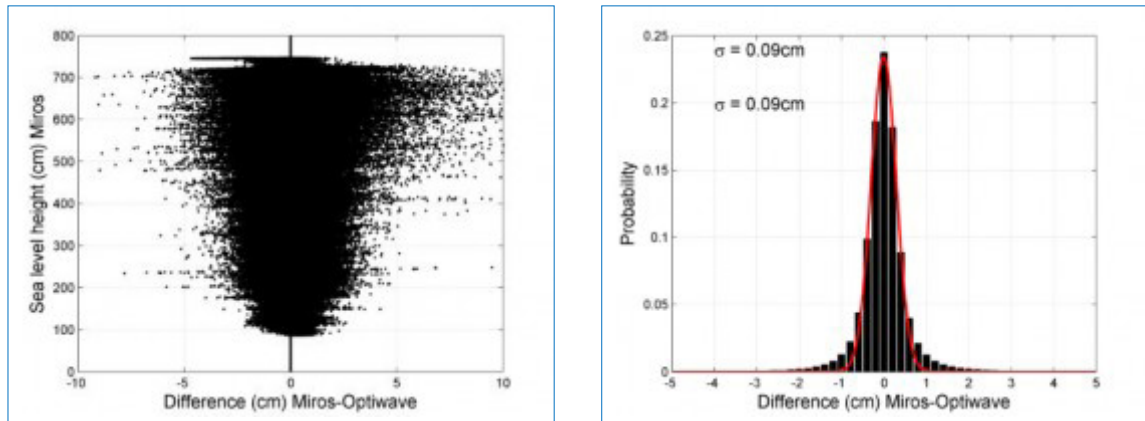

Figure 8. Van de Castele diagram (left) and errors histograms (right) of the differences between the Miros and the Optiwave sensors.

The left picture of **Figure 9** shows that Optiwave sensor is less noisy than Miros Sensor. Nevertheless, Optiwave seems less robust with several spikes (up to 10cm) that would need to be filtered (**Figure 9, right**).

These spikes are difficult to explain but may be caused by side lobes or multipaths due to the environment. In particular, under bad weather conditions, side reflections on wet metal pieces around the sensor are stronger. If needed, the sensor should be installed in a stainless steel stilling well or a numerical filter should be applied to delete the spikes in post processing.

Regardless to those spikes, it is also noticeable that the dispersion of the differences seems larger at high tide rather than low tide. This pattern could be explained by a high sensitivity of the Miros sensor to the sea surface state when measuring short air gaps. Indeed, it is also visible on the **Figure 10** of the Miros but not so much on the **Figure 10** of the Optiwave.

The comparison over one month of data shows clearly some differences in sensor quality. Comparisons between the different gauges and the BM100 reference radar within the stilling well (**Figure 10**) allows to get a quick picture of each instrument's performances.

○ Conclusion

VDC diagrams as well as error histograms confirm the high performances of radar tide gauges sensor with standard deviations under good weather conditions ranging from 0.15 cm for Optiwave to 0.25 cm for CS476. Miros sensor shows the higher sensitivity to measure high frequency waves but may need to be filtered in order to smooth the sea level values. For open air installation, special attention should be given to adapt the environment to avoid or filter spikes that can reach 10 cm. On the contrary, pressure sensors offer lower performances with VDC diagrams presenting, at the beginning of the experiment,

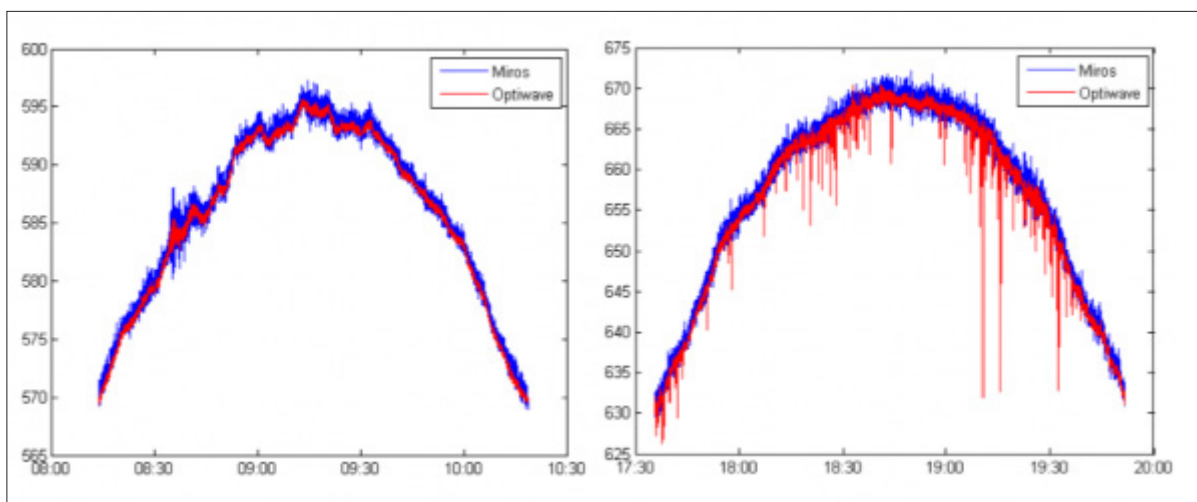

Figure 9. Zoom on sea level measurements of open air sensors Miros (blue) and Optiwave (red). These pictures show very good correlation (left), but also spikes on Optiwave data (right).

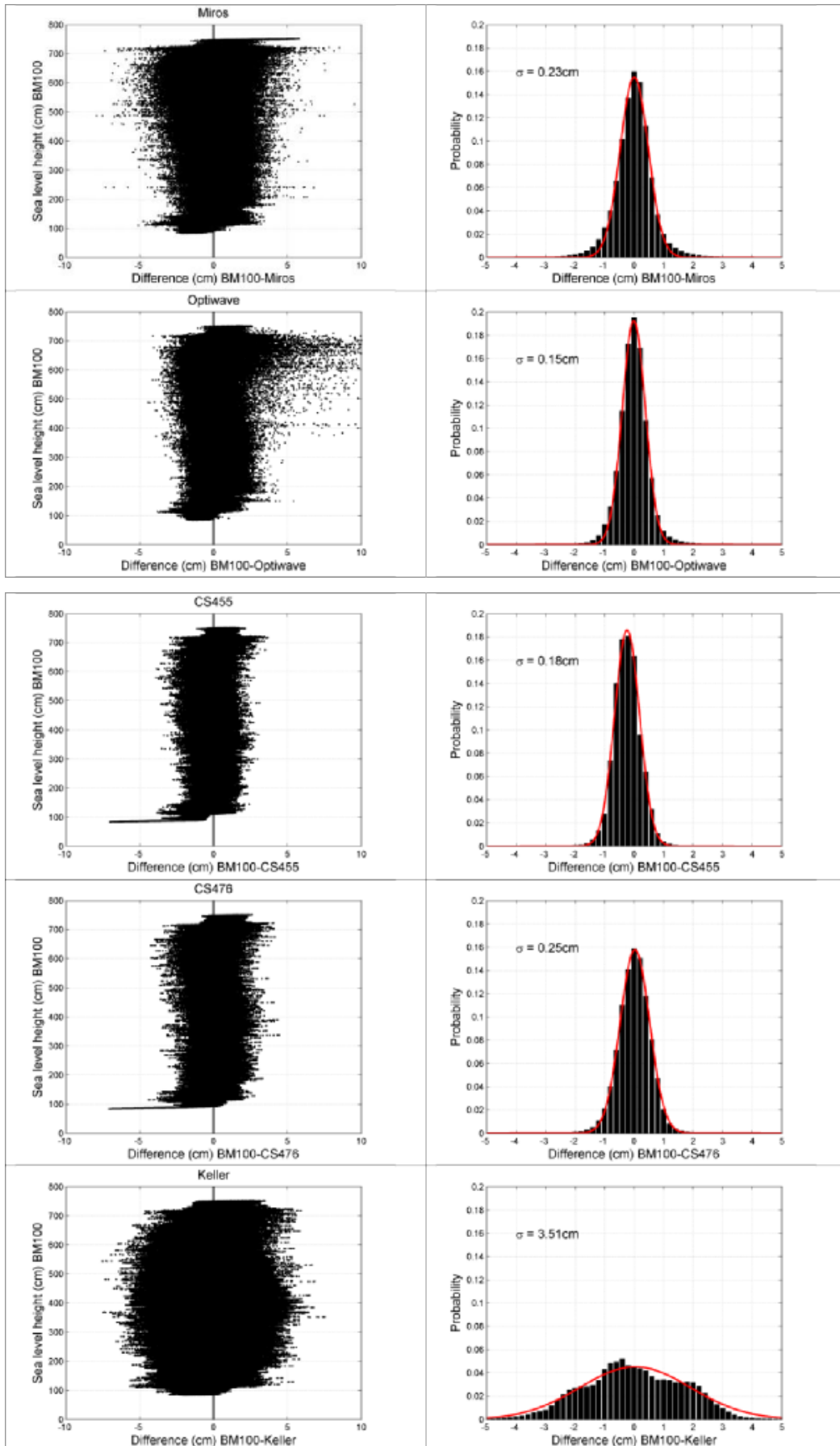

Figure 10. Van de Casteele diagram (left) and errors histograms (right) of the differences between the different gauges and the BM100 reference.

scale factor and hysteresis features. After correcting these systematic errors the time series of sea level, instrumental errors are reduced with a sigma value for CS455 of 0.18 cm and 3.51 cm for the Keller sensor. However, special attention should be given to check that pressure sensors are not drifting so that systematic errors may appear again in the long term. The drifting of pressure sensors, is a well-known problem of this technology, and can be a serious drawback for tide gauge dedicated to study the long term sea level trend (Martín Míguez et al., 2012).

○ Acknowledgments

We would like to thank the staff members at SHOM who have contributed to the development of the French RONIM network since its creation, and to the expertise on radar technology sensors that made it possible to write this contribution: Jean-Claude Kerinec, Bernard Croguennoc, Christian Kervella, Jean-Pierre Boivin, Paul Velut, Ronan Le Roy, Ronan Creach, Virginie Goirand, Thierry Lengart, Ronan Kerouanton. Special thanks to Nicolas Pouvreau for making the RONIM sea levels available on the REFMAR webportal (<http://www.refmar.shom.fr>). We also would like to acknowledge our SONEL partners (<http://www.sonel.org>) for discussions on sea level quality and geodetic references, but also for all the work done around GNSS co-localisation: Laurent Testut, Guy Wöppelmann, Mederic Gravelle, Belén Martín Míguez, Bruno Garayt, Thierry Person, Alain Coulomb, Thomas Donal, Etienne Poirier.

○ References

- Boon, J. D., Heitsenrether, R. M. and Bushnell, M. 2009. Microwave-acoustic water level sensor comparisons: sensor response to change in oceanographic and meteorological parameters. *MTE/IEEE Oceans 2009* (October), Biloxi, M.
- Blasi, C. J. 2008. A new technology for the measurement of the sea level and the sea state. *Environmental Geology*, 57, 331-336.
- IOC 1997. Global Sea Level Observing System (GLOSS). Implementation Plan - 1997. IOC Technical Series No. 50, UNESCO.
- IOC 2002. Manual on Sea-Level Measurement and Interpretation. Volume 3: Reappraisals and Recommendations as of the Year 2000. Intergovernmental Oceanographic Commission Manuals and Guides, No. 14. Paris: IOC.
- IOC 2005. Global Sea Level Observing System (GLOSS): The Group of Experts on the Global Sea Level Observing System (GLOSS). IOC/GE-GLOSS-IX/3. Ninth Session. Paris, France 24-25 February 2005. Available from: <http://unesdoc.unesco.org/images/0014/001400/140083e.pdf>
- IOC 2006. Manual on Sea-Level Measurement and Interpretation. Volume 4: An Update to 2006. Intergovernmental Oceanographic Commission Manuals and Guides, No. 14. Paris: IOC.
- Le Roy, R. 2006. Evaluation des performances des télémètres radar pour la mesure des hauteurs d'eau. SHOM, Rapport d'étude No 001/06.
- Martín Míguez, B., Pérez Gómez, B. and Álvarez Fanjul, E. 2005. The ESEAS-RI sea level test station: Reliability and accuracy of different tide gauges. *International Hydrographic Review*, 6, 44-53.
- Martín Míguez, B., Le Roy, R. and Wöppelmann, G. 2008a. The use of radar tide gauges to measure the sea level along the French coast. *Journal of Coastal Research*, 24, 4C, 61-68.
- Martín Míguez, B., Testut, L. and Wöppelmann, G. 2008b. The Van de Casteele Test Revisited: An Efficient Approach to Tide Gauge Error Characterization. *J. Atmos. Oceanic Technol.*, 25, 1238-1244.
- Martín Míguez, B., Testut L., and Wöppelmann, G. 2012. Performance of modern tide gauges: towards mm-level accuracy. *Scientia Marina*, 76S1, 221-228, doi:10.3989/scimar.03618.18A.
- SHOM 2005. Norme du SHOM sur la mesure des hauteurs d'eau. NRC2005-009.
- Woodworth, P. L. and Smith, D. E. 2003. A one-year comparison of radar and bubbler tide gauges at Liverpool. *International Hydrographic Review*, 4, 2-9.
- Woodworth, P. L., Aman, A. and Aarup, T. 2007. Sea level monitoring in Africa. *African Journal of Marine Science*, 29, 3, 321-330, doi:10.2989/AJMS.2007.29.3.2.332.
- Woodworth, P. L., Rickards, L. J. and Pérez, B. 2009. A survey of European sea level infrastructure. *Natural Hazards and Earth System Sciences*, 9, 927-934.

Water Level Measurements with Radar Gauges at the German North Sea Coast

Stephan Mai and Ulrich Barjenbruch
German Federal Institute of Hydrology,
Am Mainzer Tor 1, 56068 Koblenz, Germany

*Contact person: S. Mai
E-mail: mai@bafg.de*

○ Introduction

For more than a decade radar level gauges have been used in operational coastal hydrology in Germany (Kranz et al. 2001). Besides measuring water levels tests have been undertaken in order to acquire also the thickness of an ice cover (Barjenbruch et al., 2002) or the sea state (Wilhelmi and Barjenbruch, 2008). Four test sites for the use of radar level gauges are located in German coastal waters of the North Sea. Two of these test sites, one near the island Borkum and the other on the research platform FINO 1 about 45 km north of the island Borkum, are equipped with arrays of four radar level sensors which provides the opportunity to measure 2D wave spectra in addition to the water level (Rütten et al., 2013 and Blasi et al., 2014). The third test site, located at the lighthouse "Alte Weser", is equipped with a single radar level sensor measuring 1D wave spectra (i.e. not wave direction) in addition to the water level. A fourth test site equipped with an array of five radar level sensors was installed at the research platform FINO 3 in July 2015. An overview over the test sites is given in **Figure 1** (see also Mai et al. (2010)).

At all sites alternative devices for water level measurement are available for a comparison to the results of the radar measurement. E.g. a float with shaft encoder in a stilling well is permanently in operation near the island Borkum and at the lighthouse "Alte Weser".

The use of radar level sensors for water level measurement is well documented by IOC (2006 and 2015). However there are remaining questions when discussing the accuracy of radar sensors, i.e. agreement of radar sensors and alternative (traditional) devices for measuring water level. It is reported that deviations in water level measurement derived from radar sensors and traditional devices may relate to the air gap between radar sensor and water surface (Fulford et al. (2010)) or to sea state conditions (Woodworth and Smith (2003), Martin Miguez et al. (2005), Heitsenrether et al. (2008)). Therefore special focus is put on these questions in the following.

○ Description of the radar level sensor for monitoring of water level and 1D sea state

A radar gauge for monitoring the water level and 1D sea state has been in operation at the lighthouse "Alte Weser" since 2006. This gauge consists of a single radar sensor (type: VegaPuls 42) and a ruggedized PC with embedded Linux. Real time calculations of water level and 1D sea state parameters, like mean wave period, significant and maximum wave height, are carried out by using the software Octave, which is in fact a freeware version of the software Matlab (Wilhelmi and Barjenbruch, 2008). Both water level and wave parameters are processed every

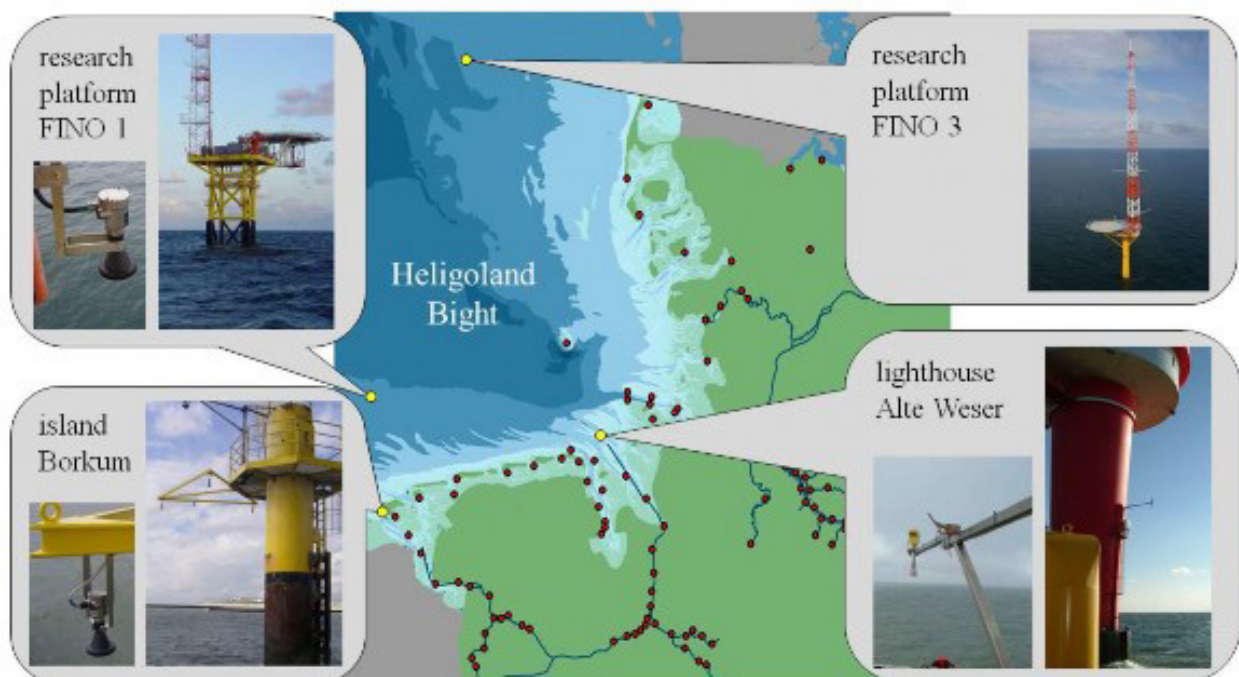

Figure 1. Test sites for the use of radar level gauges in German coastal waters of the North Sea.

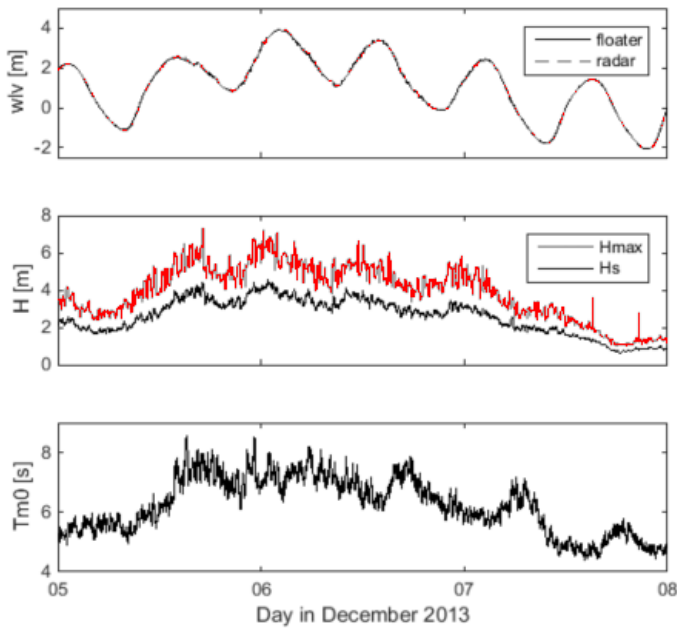

Figure 2. Water level (wlv), significant/maximum wave height (H) and mean wave period (Tm0) at the lighthouse "Alte Weser" during the storm "Xaver"

minute. While each 1-minute value of water level relates to measurements within the last minute, wave parameters are calculated every minute from measurements of sea surface elevation of the last 15 minutes. Water level and wave data are automatically transferred on-line to the operational hydrological data base of the waterways and shipping administration.

An example of a time-series of water level, significant/maximum wave height and mean wave period recorded at the lighthouse "Alte Weser" during the storm "Xaver" in December 2013 is given in **Figure 2**.

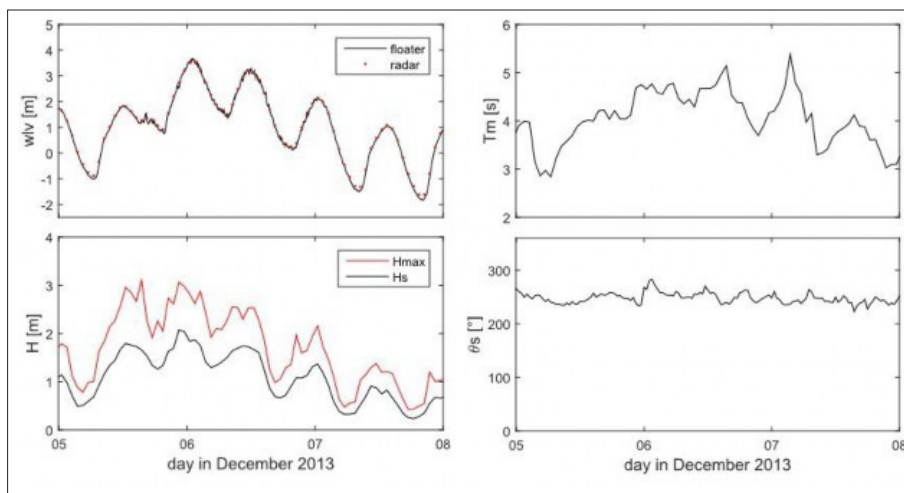

Figure 4. Water level (wlv), significant/maximum wave height (H), mean wave period (Tm) and wave direction (θ) at the gauge "Borkum" during the storm "Xaver".

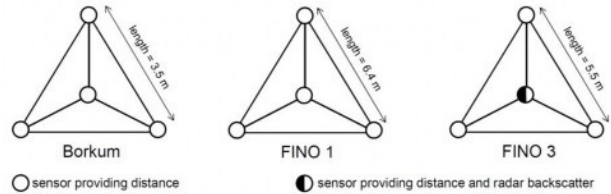

Figure 3. Star configuration of sensors within the radar arrays at Borkum, FINO 1 and FINO 3.

○ Description of an array of radar level sensors for monitoring of the water level and the 2D sea state

The array system for monitoring of the water level and the 2D sea state consists of at least of three radar level sensors similar to that being described in the previous chapter. Our system uses four sensors in a star configuration (**Figure 3**) fulfilling the requirements with respect to the measurement of 2D sea state given by Goda (1985). The edge length of the star array varies from site to site depending on the geometry of the available offshore structure. The data acquisition and control of all sensors (type: VegaPuls 61) of each array is done by a ruggedized, remotely controlled PC with embedded Linux. The water level and the 1D sea state are independently calculated from time-series of each sensor. The directional information (2D sea state) is estimated by making use of the cross-covariance spectral densities between the recordings at all sensor locations. Further information is given by e.g. Benoit et al. (1997). At the site of FINO 3 the radar backscatter intensity is additionally recorded with an additional radar sensor in the center. The backscatter data may help to provide information on wave breaking and may help to explain varying accuracies of the radar level measurements in future.

An example of a time-series of water level, significant/maximum wave height, mean wave period and wave direction recorded near the island Borkum during the storm "Xaver" in December 2013 is given in **Figure 4**.

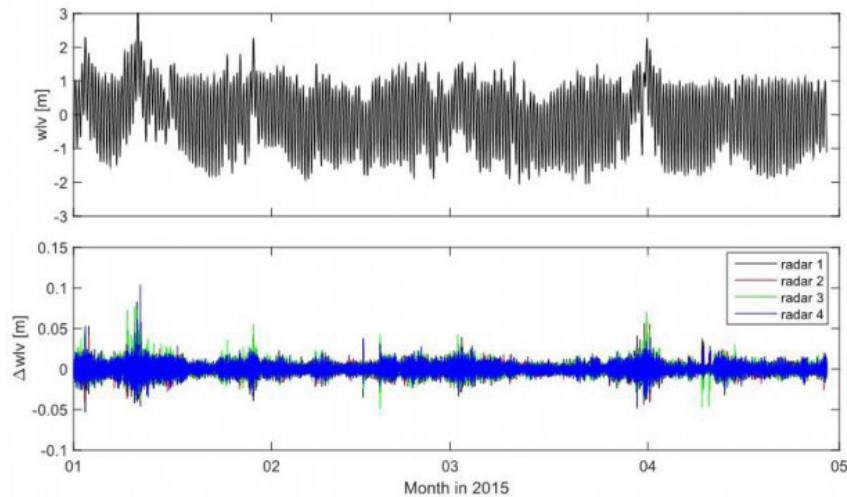

Figure 5. Averaged water level at Borkum and deviation of each sensor from the average

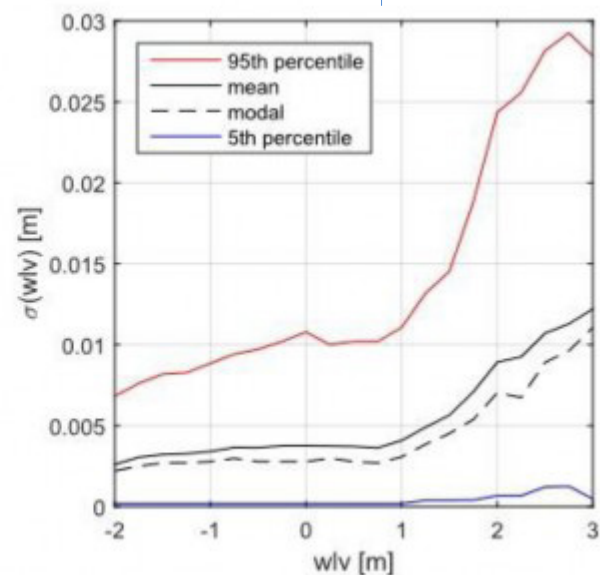
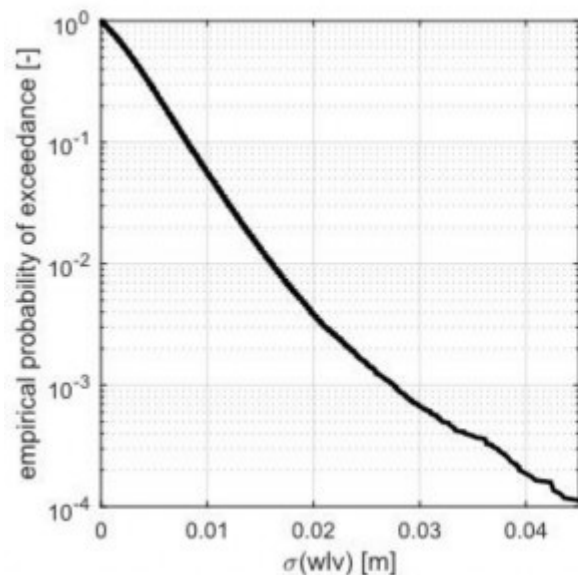

Figure 6. Standard deviation of water level measurements with 4 radars at Borkum: empirical probability of exceedance (left) and standard deviation versus water level (right).

○ Measurement uncertainty of the radar system in water level monitoring

The arrays used at the sites Borkum and FINO 1 allow the analysis of the intrinsic variance of water level measurements by radar sensors. For a time period from 1st of January 2015 to 28th of April 2015 water levels were calculated using each of the four radar sensors separately. 1-minute values of water levels were calculated from the original data sampled with 2 Hz without any filtering. The time-series of the average water level and of their deviation from the average is given in [Figure 5](#). The maximum deviation of a 1-minute value of a single sensor from the mean of the 1-min values of all sensors was 0.1 m. However only in 1 out of 10000 1-min values of water level the standard deviation between the data of the four sensors is larger than 0.045 m ([Figure 6, left](#)).

As visible in the time series of the water level and of the deviation of the data of different sensors ([Figure 5](#)) the standard deviation of the 1-min values of all sensors seems to increase under the condition of higher water levels. A quantification of this is given in [Figure 6](#). For the site near Borkum the mean of the standard deviation of the 1-min values of all sensors equals about 0.003 m for water levels below 1 m. For water levels of 3 m it increases to 0.012 m (on average). A change in sea state and not a change in air gap is probably the reason for the increase of standard deviation with increasing water level (i.e. decreasing air gap) since water levels above 2 m occur especially during westerly and northwesterly storms causing also higher sea state conditions.

Since the radar system also monitors sea state, it is possible to check for the influence of the sea state (calculated for 15 min periods) on the standard deviation of the 1 min

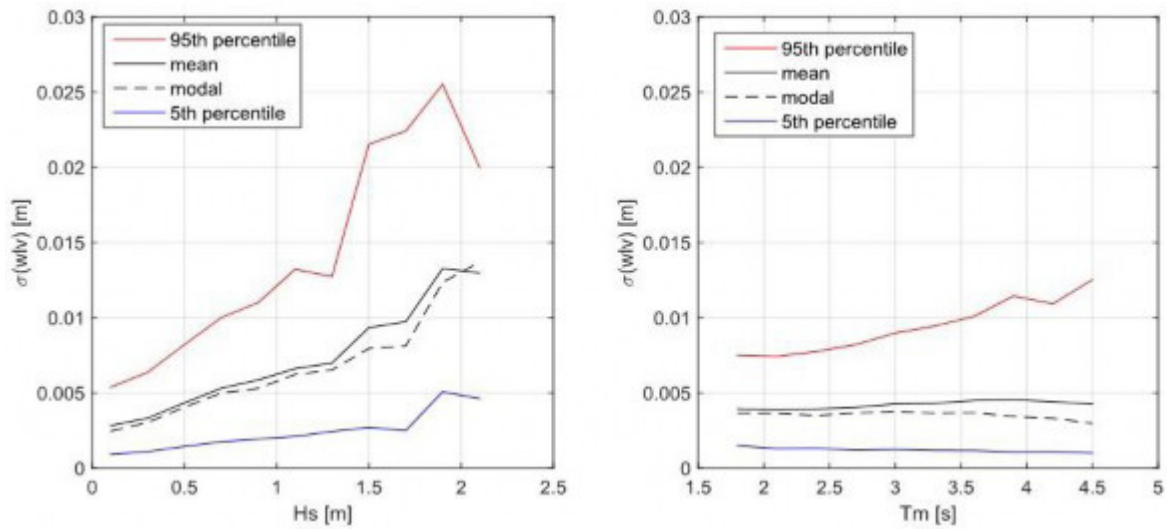

Figure 7. Influence of sea state on the standard deviation of water level measurements with 4 radars at Borkum: effect of significant wave height (left) and effect of mean wave period (right).

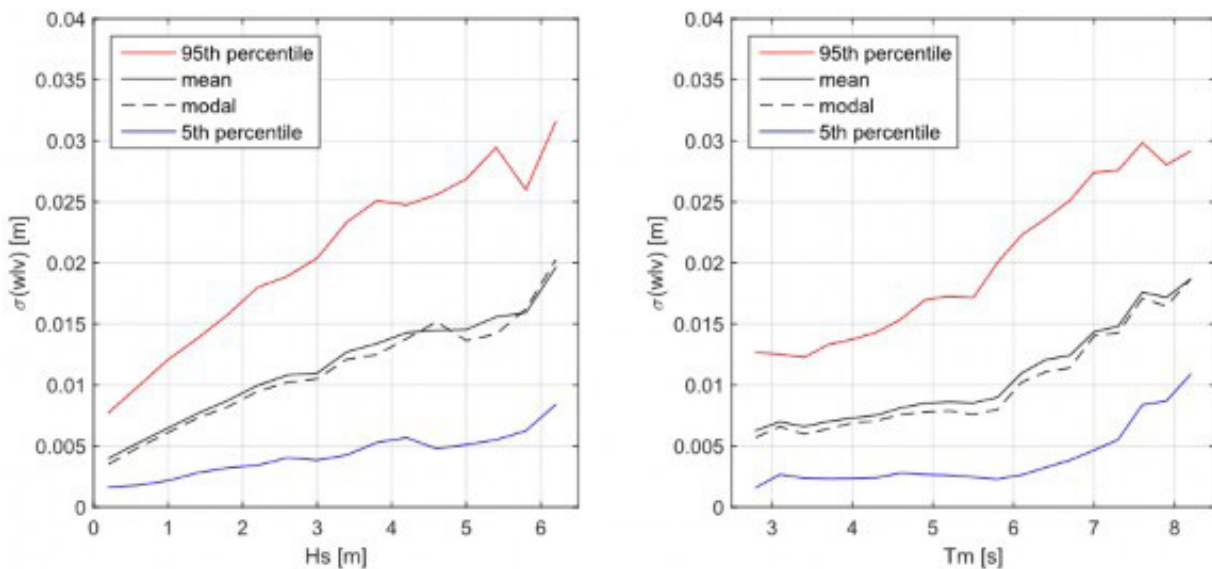

Figure 8. Influence of sea state on the standard deviation of water level measurements with 4 radars at FINO 1: effect of significant wave height (left) and effect of mean wave period (right).

water level values derived from all radar sensors. **Figure 7** shows the effect of a change in significant wave height (H_s) on the standard deviation (right) and the effect of a change in mean wave period (T_m) (left). The significant wave height strongly influences the standard deviation of the measurements given by the different sensors while, on average, the wave period does not have a significant influence at Borkum. At Borkum the increase of the significant wave height from 1 m to 2 m leads to an increase in standard deviation from 0.006 m to 0.012 m. This is in good agreement with the microwave sensor error found by Boon et al. (2012) at Duck field research facility.

Similar results are found at the research platform FINO 1 in case of calm wave conditions (i.e. $H_s < 2.5$ m, $T_m < 5.5$ s) (**Figure 8**). In case of more severe wave conditions the standard deviation of the 1 min water level values given by all radar sensors increases almost linearly with the significant wave height. A non-linear (quadratic) increase as expected by Boon et al. (2012) is not found at FINO 1. The average of the standard deviation equals 0.02 m in case of a significant wave height of 6 m. The increase of the standard deviation of 1 min values of water level with mean wave periods above approximately 5.9 s is probably related to an increase in wave height with

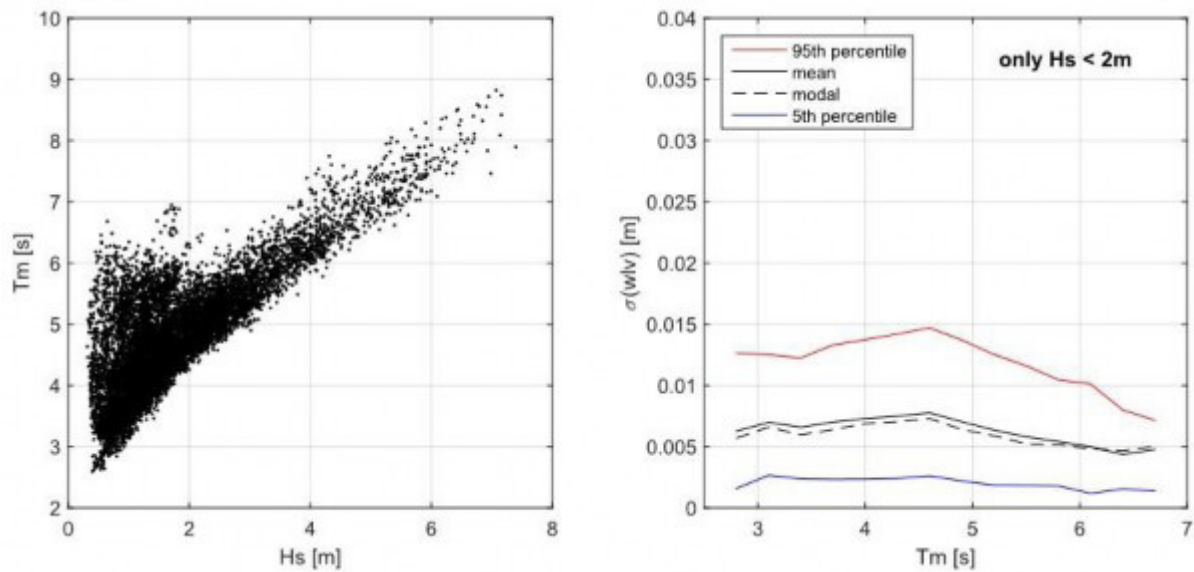

Figure 9. Correlation of significant wave height and mean wave period at FINO 1 (left), influence of mean wave period on the standard deviation of water level measurements with 4 radars for significant wave heights $< 2m$ (right).

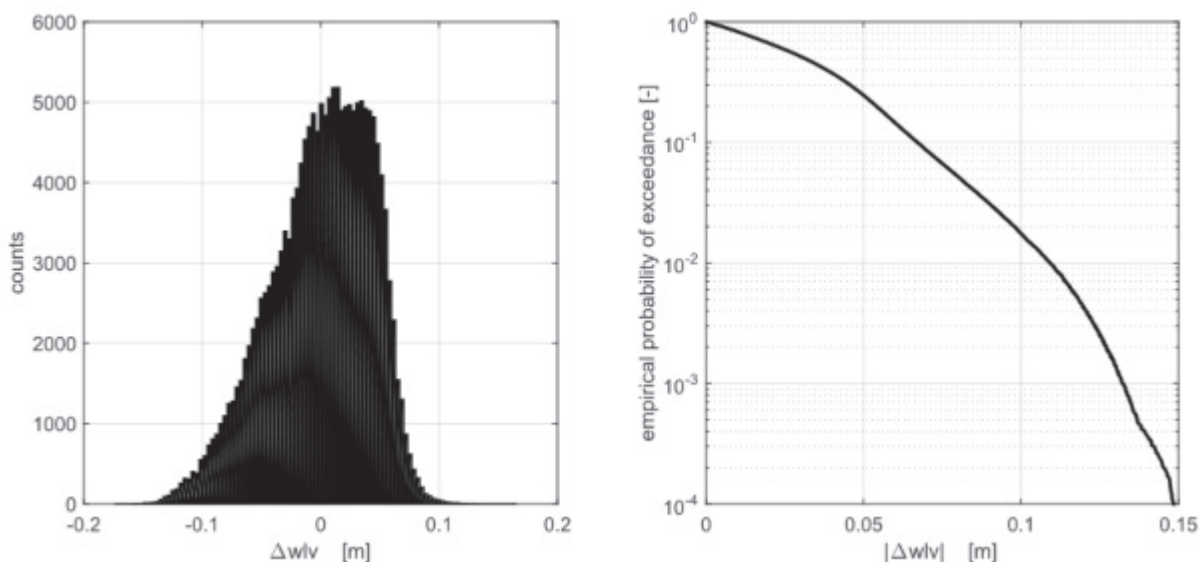

Figure 10. Histogram of deviations of 1 min values of water level measurements measured with radar array and float in a stilling well near Borkum (left) and empirical probability of exceedance of the absolute deviation (right).

increasing wave periods (Figure 9). When analyzing wave events with $H_s < 2m$ only, no effect of the mean wave period on the standard deviation of 1 min values of water level is found.

The above given estimate of the intrinsic uncertainty of radar sensor measurements is the lower bound when comparing radar measurements with those by traditional devices, like floats with shaft encoders in stilling wells. For the site near Borkum a comparison of radar measurements with those of a float in a stilling well is given in the following. The analysis bases on the time-

series as given in Figure 5. A histogram of the deviation of the 1 min values of water level (one coming from the radar array (average of the four radar time-series), the other coming from the traditional system) is given in Figure 10 (left). The probability of exceeding a certain absolute deviation is given in Figure 10 (right). The distribution of these deviations is platykurtic (not normally distributed). The standard deviation of the distribution equals 0.04 m. The skewness is -0.48 and the kurtosis is 2.77 (excess kurtosis: -0.23). At the site near Borkum the deviation between the measurements of the radar array and of the float in a stilling well is larger than

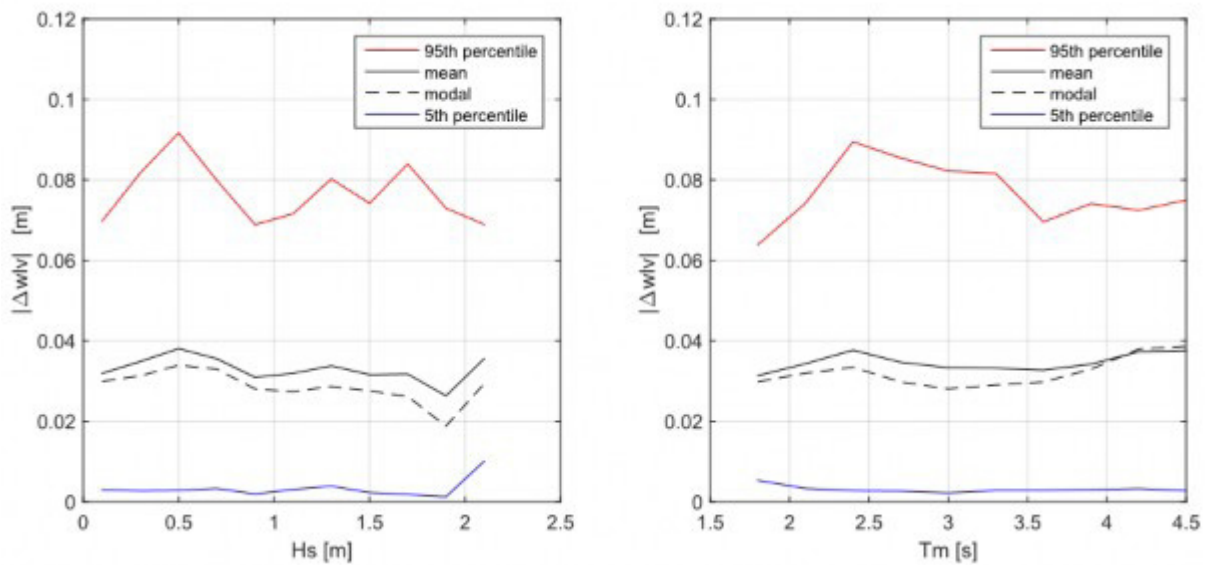

Figure 11. Influence of sea state near Borkum on the deviation between water level measurements with a radar array and a float in a stilling well: effect of significant wave height (left) and effect of mean wave period (right).

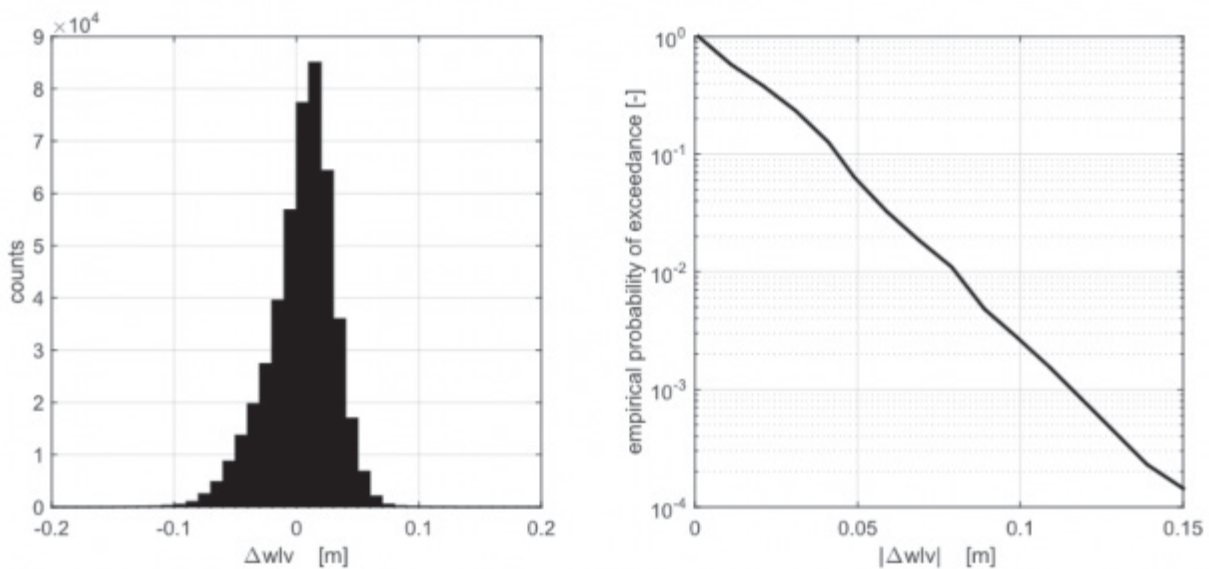

Figure 12. Histogram of deviations of 1 min values of water levels measured with a single radar sensor and a float in a stilling well at the lighthouse “Alte Weser” (left) and empirical probability of exceedance of the absolute deviation (right).

0.07 m for about 10 percent and larger than 0.12 m for about 1 percent of the measured values [Figure 10](#) (right). This is about eight to ten-times the intrinsic uncertainty of the radar measurements ([compare to Figure 6, left](#)). During the 4 month of analysis the deviation between the measurements with the radar array (average of four radar sensors) and the float in a stilling well does not seem to depend on the sea state (significant wave height, mean wave period) at Borkum, as [Figure 11](#) elucidates. However, this may change under the condition of larger significant wave heights (larger than 2 m). Similar results are found when carrying out a comparison of the data

sets acquired with a single radar sensor of the array and the traditional device.

At the lighthouse “Alte Weser” the comparison of radar measurements with those of a float in a stilling well revealed less deviation (time of analysis: April 2009 to February 2010). A histogram of the deviation of the 1 min water level values (one coming from the single radar sensor, the other coming from the traditional system) is given in [Figure 12](#) (left). The probability of exceeding a certain absolute deviation is given in [Figure 12](#) (right). The histogram of deviations between measured 1

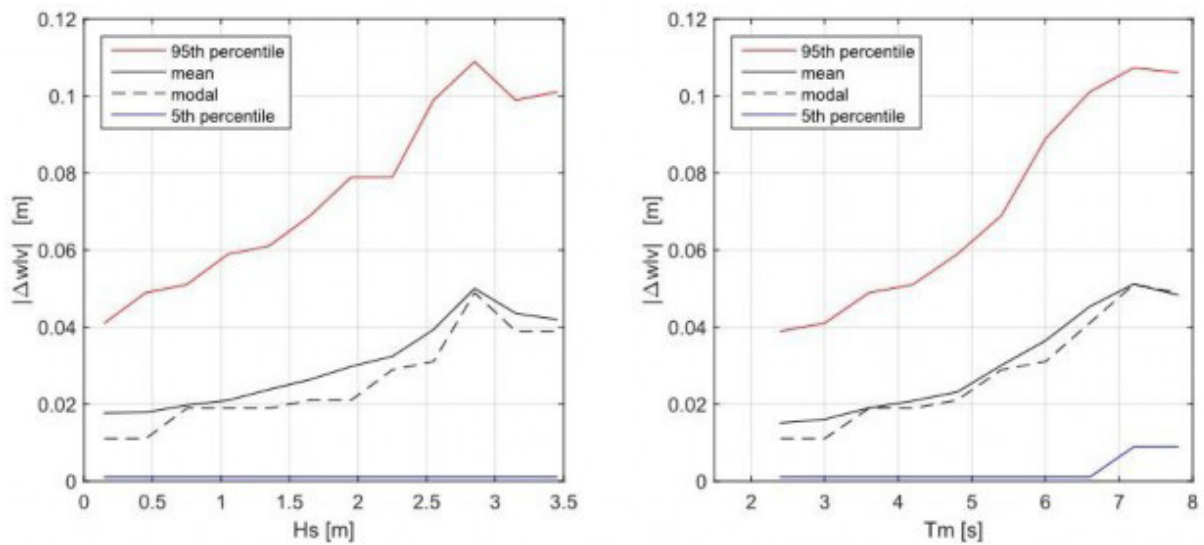

Figure 13. Influence of sea state at the lighthouse “Alte Weser” on the deviation between water level measurements with a single radar sensor and a float in a stilling well: effect of significant wave height (left) and effect of mean wave period (right)

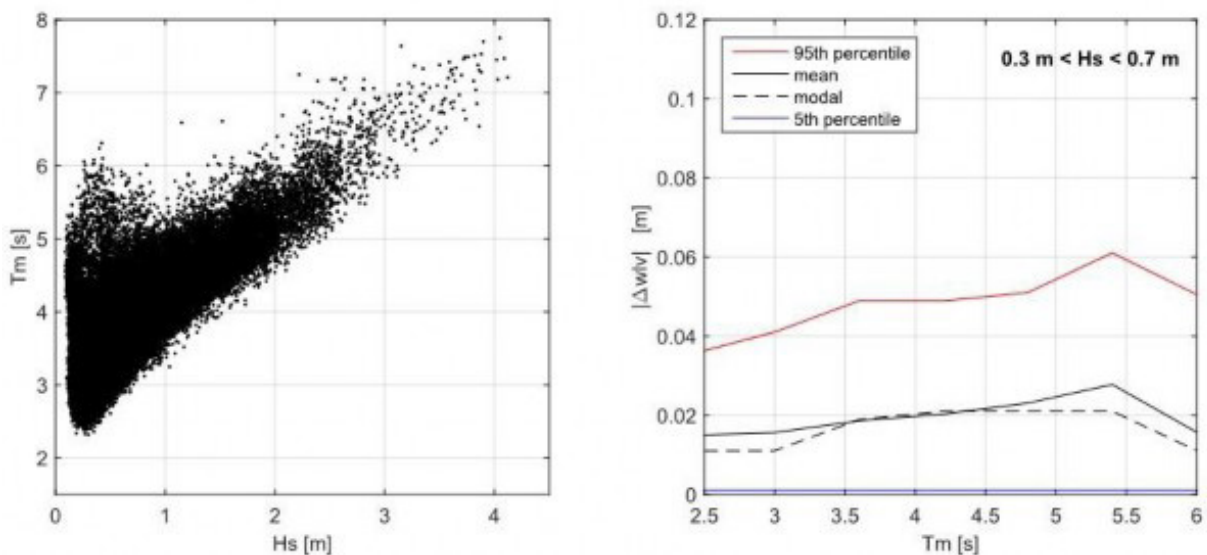

Figure 14. Correlation of significant wave height and mean wave period at lighthouse “Alte Weser” (left), influence of mean wave period on the standard deviation of water level measurements with 4 radars for significant wave heights with $0.3 \text{ m} < H_s < 0.7 \text{ m}$ (right).

min water level values is leptokurtic (in contrast to the site near Borkum). The distribution shows a standard deviation of 0.03 m, a skewness of -0.61 and a kurtosis of 4.56 (excess kurtosis: +1.56). At the lighthouse “Alte Weser” the deviation between the data of the radar sensor and the float in a stilling well is larger than 0.04 m for about 10 percent of the measured values and larger than 0.08 m for about 1 percent of the measured values (**Figure 12, right**).

In contrast to the site near Borkum a dependence of the deviation between the water level measurements with the radar sensor and the float in a stilling well on

the sea state is found for the analysed 10 month period at the lighthouse “Alte Weser”, as shown in **Figure 13**. An increase in wave height from 1.5 m to 3 m seems to double the mean deviation. As found for the standard deviation of the different sensors of the radar array at FINO 1 the increase of the deviation of 1 min water level values with mean wave periods at the lighthouse “Alte Weser” is also probably related to an increase in wave height in case of increasing wave periods (**Figure 14**). When analyzing wave events with $0.3 \text{ m} < H_s < 0.7 \text{ m}$ only, no effect of the mean wave period on the deviation of 1 min values of water levels is found.

○ Conclusion

The analysis of measurements with radar arrays in German coastal waters reveals that the intrinsic uncertainty of radar water level measurements increases linearly with the wave height (at least up to $H_s < 6$ m) and does not depend on wave period. Without waves the standard deviation equals approx. 0.003 m and with waves ($H_s=2$ m) approx. 0.01 m (slightly depending on the site).

When comparing radar water level measurements with those undertaken with a float in a stilling well the accuracy is less good. For a long-term comparison an average standard deviation of 0.03 m (lighthouse "Alte Weser") is found. The deviation of radar and float in a stilling well seems to increase with wave height as well and does not significantly depend on wave period. Without waves the average absolute deviation equals approx. 0.017 m and with waves ($H_s=3$ m) approx. 0.04 m.

Future work at German test sites will focus on advanced filtering techniques for radar measurements as e.g. proposed by Boon (2014) and on using radar backscatter intensity as an indicator for the validity of a single radar distance measurement.

○ References

- Barjenbruch, U., Mai, S., Ohle, N. and Mertinatis, U. 2002. Monitoring water level, waves and ice with radar gauges, Proc. of the Hydro 2002 Conference, pp. 328-337, Kiel, 2002.
- Benoit, M., Frigaard, P. and Schaffer, H. A. 1997. Analyzing multidirectional wave spectra: A tentative classification of available methods. Proc. Seminar on Multidirectional Waves and their Interaction with Structures, San Francisco, CA, International Assembly of Hydraulic Research, 131- 158.
- Blasi, C., Mai, S., Wilhelmi, J., Zenz, T. and Barjenbruch, U. 2014. A powerful method of measuring sea wave spectra and their direction. Proceedings of 11th International Conference on Hydrosience and Engineering, Hamburg, Germany, 913-920.
- Boon, J.D., Heitsenrether, R.M. and Hensley, W.M. 2012. Multi-Sensor Evaluation of Microwave Water Level Measurement Error. Proc. of Int. Conf. Oceans 2012, Hampton Roads, (DOI: 10.1109/OCEANS.2012.6405079)
- Boon, J.D. 2014. Reducing Wave-Induced Microwave Water-Level Measurement Error with a Least Squares-Designed Digital Filter. Journal of Atmospheric and Oceanic Technology, Vol 31, 491-502.
- Fulford, J.M., Ester, L.W. and Heaton, J.W. 2010. Accuracy of radar water level measurements. US Geological Survey report.
- Goda, Y. 1985. Random Seas and Design of Maritime Structures. Univ. Tokyo Press.
- Heitsenrether, R.M., Bushnell, M.H. and Boon, J.D. 2008. Understanding the Impact of Surface Waves on Microwave Water level Measurements. Proc. of Int. Conf. Oceans 2008, Kobe (DOI: 10.1109/OCEANS.2008.5151923).
- IOC, 2006. Manual on Sea-Level Measurement and Interpretation. Volume 4: An Update to 2006. Intergovernmental Oceanographic Commission Manuals and Guides No. 14. Paris: UNESCO/Intergovernmental Oceanographic Commission.
- IOC, 2015. Manual on Sea-Level Measurement and Interpretation. Volume 5: Radar Gauges. Intergovernmental Oceanographic Commission Manuals and Guides, this issue, Paris: UNESCO/Intergovernmental Oceanographic Commission.
- Kranz, S., Zenz, T. and Barjenbruch, U. 2001. Radar: Is it a new technology applicable to water level gauging, Physics and Chemistry of the Earth (C), 26, 10-12, 751-754
- Mai, S., Wilhelmi, J. and Barjenbruch, U. 2010. Wave height distributions in shallow waters. Proceedings of the 32nd International Conference on Coastal Engineering (ICCE), Shanghai, China.
- Martín Míguez, B., Pérez Gómez, B. and Álvarez Fanjul, E. 2005. The ESEAS-RI sea level test station: Reliability and accuracy of different tide gauges. International Hydrographic Review, 6, 1. 2-11.
- Rütten, S., Mai, S., Wilhelmi, J., Zenz, T. and Fröhle, P. and Barjenbruch, U. 2013. Directional wave spectra measurement by an array of radar gauges. Proceedings of the 7th International Conference on Coastal Dynamics, Arcachon, France, 1397-1406.
- Wilhelmi, J. and Barjenbruch, U. 2008. Application of radar gauges to measure the water level and the sea state, Proceedings of 31st International Conference on Coastal Engineering, ASCE, 687-695.
- Woodworth, P.L. and Smith, D.E. 2003. A one year comparison of radar and bubbler tide gauges at Liverpool. International Hydrographic Review, 4(3), 42-49.

Experiences with Radar Gauges at BKG (Germany)

Elke Kühmstedt and Gunter Liebsch
Federal Agency for Cartography and Geodesy,
Karl-Rothe-Straße 10–14, 04105 Leipzig, Germany

*Contact person: E. Kühmstedt
E-mail: elke.kuehmstedt@bkg.bund.de*

○ Introduction

The Federal Agency for Cartography and Geodesy operates several geodetic reference stations as well as observatories in Germany and other countries. At these stations, a number of observations are carried out, like GNSS measurements, gravity measurements, levelings, tide gauge measurements, VLBI and SLR measurements. At two of these stations radar gauges were installed. One radar gauge is located in the southern Baltic Sea in the harbor of the city Sassnitz, Germany. The other one is situated at the German Antarctic Receiving Station (GARS) at the Antarctic Peninsula. Accordingly, the operational and environmental conditions at these stations are very different. While the gauge in Sassnitz is located in a well-protected environment, the station GARS O'Higgins is located unprotected directly on the coast. The radar gauge in O'Higgins can be operated only 1 or 2 months each year because of moving icebergs in the bay and the frozen sea.

In Sassnitz as well as at GARS O'Higgins there are additional tide gauges that use different measurement principles. The comparison with these gauges enables an independent validation of the radar gauge.

Both radar gauges are equipped with a GPS antenna mounted on top of the radar gauge (**Figure 1**). The combination of radar gauges and GPS antenna allows the determination and the continuous monitoring of the zero point of the tide gauge, with respect to the local GNSS reference station. The GPS sensor replaces the time consuming levelings, which cannot be carried out at locations with an infrastructure like O'Higgins. Furthermore, it enables the determination of the zero point with respect to the global geodetic reference frame. Since the distance between radar gauge and GNSS reference station is only a few hundred meters, a low cost single frequency receiver is sufficient in order to monitor the stability of the tide gauge with a precision of a few millimeters with respect to the GNSS reference station. The GNSS reference stations are part of national and international GNSS networks and are analyzed in that frame on a daily basis. Thus, the height of the radar gauge with respect to the official national and international reference frames can be determined with a high precision.

These measurements can also be used as a basis for further scientific studies. Examples include the determination of long-term absolute sea level changes, the validation of

satellite altimeter measurements and the determination of vertical crustal movements. Thus, the research results provide direct contributions to the understanding of climate and environmental issues.

○ Installation

General

BKG has taken into account the following main requirements when building a new radar gauge station.

1. realize a stable mount for the radar gauge, normally a metal arm
2. ground the metal arm (thunderstorm)
3. choose position of the radar transducer so that disturbance echoes do not exist or are minimized, respectively
4. collision protection (shipping traffic, ice drift) if necessary
5. mount a GPS antenna on top of the radar gauge, note the free horizon view
6. power supply and internet connection for data transfer are necessary
7. existence of a GNSS reference station nearby (range of a few kilometers)
8. use components in professional quality, including computer and all the electrical and electronic components
9. use components which are suitable for contact with salt water and for the expected temperature range
10. observe health and safety when working close to the water
11. measure the height of the radar gauge and the GNSS reference station every 2-3 years by traditional high-precision geodetic methods (leveling) if possible

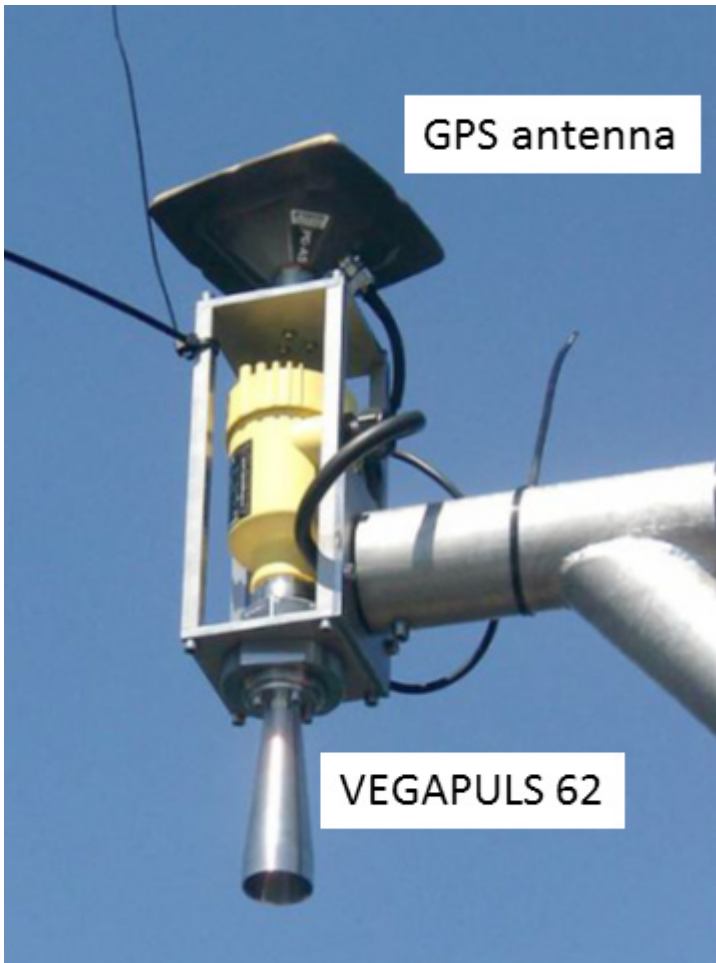
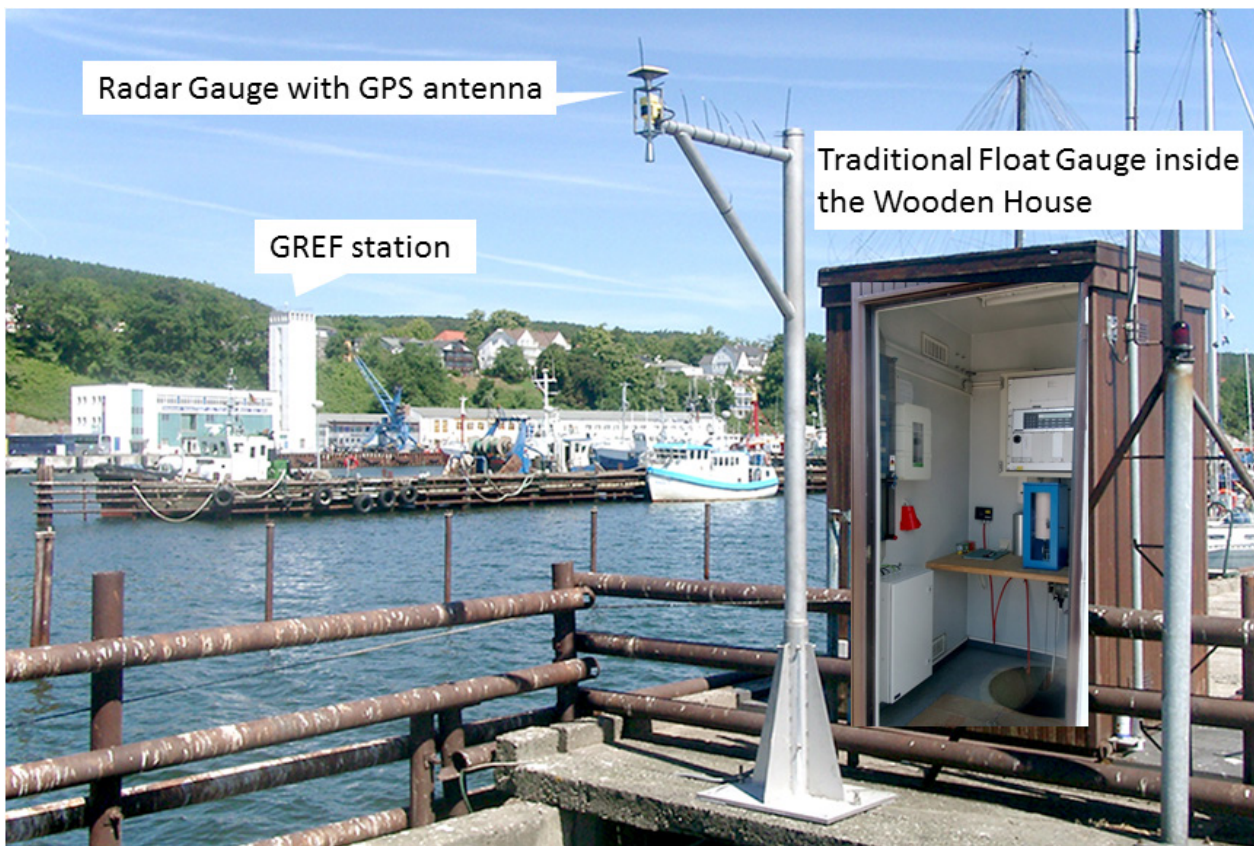

Figure 1 GPS antenna mounted above pulse radar gauge VEGAPULS 62 in Sassnitz, Germany.

Figure 2 Radar gauge mounted on metal arm with GPS antenna on top together with the GREF station and the wooden house with the traditional floating gauge inside in Sassnitz (look inside is a photo montage).



Characteristics/Fact Sheet of the two Radar Gauges of BKG

		Sassnitz, Germany	GARS O'Higgins	
General	Location	<ul style="list-style-type: none"> in north-east Germany at the Baltic Sea on the island Rügen in a harbor 	<ul style="list-style-type: none"> at the German Antarctic Receiving Station (GARS) GARS is established at Chilean Antarctic Base Bernardo O'Higgins about 30 km south-west of northernmost point of the Antarctic Peninsula on a cliff edge to the open sea 	
	Approximate coordinates	54°30–49-N 13°38–36-E	63°19–15-S 57°53–55-W	
	Installed	July 2006 out of Service: since June 2012	2011 operated only seasonally, in the Antarctic summer	
	Schedule	rebuilding planned in 2015		
Equipment and Measurement Values	Radar Gauge Device	pulse radar gauge VEGAPULS 62 radar frequency 26 GHz horn antenna, diameter 40 mm, beam angle 22 deg socket length 100 mm output 4..20 mA/HART		
		VEGAPULS WL 61 (Figure 12) in use since April 2016		
		Configuration by software "PACTware" ¹⁾ VEGAPULSE 62: application: "storage tank" VEGAPULSE WL61: we will test application mode: "open water (gauge measurement)" and "demonstration" to choose the suitable one		
	Radar Gauge Control Unit	VEGAMET 624 with RS232		
		VEGAMET 391 with Ethernet connection, since April 2016		
	measured values	timestamp, distance every 5 seconds		
	mount of radar gauge	short metal arm (Figure 2)	long metal arm on the cliff edge (Figure 4) connected via Ölflex® cable 550P 3G1,5	
	Special Features	shipping traffic → collision protection is necessary	arm with radar gauge can be assembled and disassembled (Figure 5)	
	GPS / GNSS	GPS antenna on top of the gauge	Topcon PG-A5: from July 2006 . . . May 2007 Javad JPS Regant: from May 2007 . . . June 2012	Topcon PG-A5 from 2011 . . . 2014 (2 antennas, because of damages) navXperience 3G+C, from January 2015
		GPS receiver	Topcon Legacy-H (receive GPS L1 frequency)	
GNSS reference station		GNSS reference station is a few hundred meters away measuring rate: 1 second (RINEX data format)		
		GREF station Sassnitz SASS DOMES Number 14281M001 (Figure 2)	IGS GNSS reference station? named OHI3 IERS DOMES Number 66008M006	
measured values		all GPS/GNSS data: 1 second (RINEX data format)		
Computer	Computer in industrial quality <ul style="list-style-type: none"> stores all data transmits data to database via internet 			

1 With the configuration software (PACTware) for the VEGAPULS radar gauges, it is important to choose the suitable application mode. By choosing an application mode, a set of preset parameters will be loaded to the gauge. These parameters for instance determine the reaction time (damping) of the gauge when the water level changes quickly (waves). The chosen application (or the set of manually changed special parameters) should be given together with the measurement values. Application: "open water" or "storage tank" suitable for slowly varying water level
Application: "demonstration" gives the (nearly) unfiltered value

Equipment and Measurement Values	Other Gauges	Other Gauge Devices	traditional float device of the WSA (stilling well) (Wasser- und Schifffahrtsamt, Waterways and Shipping Office) Point number gauge SASSNITZ: 9670065	<ul style="list-style-type: none"> - absolute pressure gauge S-2001 Multi Parameter Sensor from the firm "hs engineers", Dr. Schlüter, Lichtenhagen, Germany. - Barometer, Data Logger DCX-22SG of the firm Keller, CH
		measured values	timestamp, water level: 1 minute	<ul style="list-style-type: none"> - Raw data burst measurement: Once an hour starts a burst measurement with a duration of 17 min 4 sec. measurement rate: 4 Hz single measurements: 4096 measurement values: pressure temperature conductivity Barometer: every 10 min (timestamp, air pressure) - Calibrated and averaged values: Every hour (at 8 min 32 sec), one value is calculated for pressure, temperature, conductivity and three wave parameters from the calibrated and averaged burst values. - Water Level: Once an hour (at 8 min 32 sec), the water level is calculated from the calibrated and averaged values of the pressure gauge and the air pressure values.
Data Availability		Data	<u>Radar gauge:</u> 2007 .. July 2012. since April 2016 <u>traditional floating gauge:</u> 2007 .. March 2012 (more data via WSA)	<u>Radar gauge:</u> 2011-02-21 .. 2011-03-31 2012-01-19 .. 2012-04-14 2012-12-20 .. 2013-04-26 2014-03-05 .. 2014-04-28 2015-01-29 .. until now (March 2015) and ongoing up to about end of April 2015 <u>Absolute pressure gauge:</u> 2011-02-18 .. 2011-09-29 2012-03-08 .. 2013-05-03 many gaps in 2013 2014-02-08 .. until now (March 2015) and ongoing <u>Barometer:</u> 2011-02-07 .. until now (March 2015) and ongoing

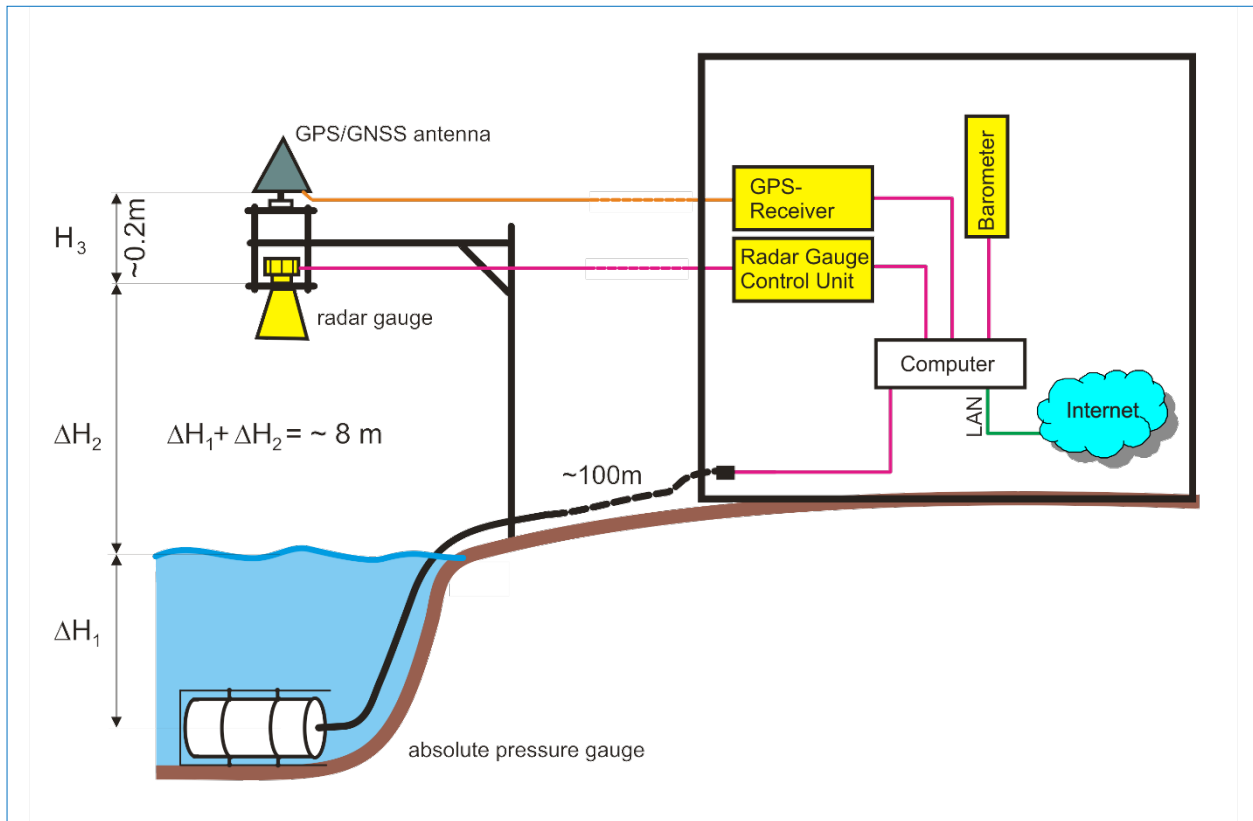

Figure 3 Overview of the complete gauge system in GARS O'Higgins, Antarctica.

Special Features of the Installation in Sassnitz

The radar gauge is beside the official traditional floating gauge of the WSA and the GNSS reference station is close-by too (Figure 2).

Special Features of the Installation at GARS O'Higgins

This gauge system at GARS O'Higgins consists of two main instruments: i) the absolute pressure gauge and ii) the radar gauge combined with a GPS antenna. Figure 3 gives you an overview of the complete gauge system.

The absolute pressure gauge is the main sensor for the determination of the sea level heights. It can be operated throughout the whole year. Nevertheless, a long-term stable mount of the gauge on the sea bottom is hardly possible at GARS.

The second tide gauge shall compensate this disadvantage. The combination of a radar gauge and a GPS antenna enables reliable sea level measurements and the monitoring of the zero level of the radar gauge, both at the same time, nearly at the same place and with a high temporal resolution. The radar gauge is located

at the cliff edge. Thus, it is mounted on a relatively long metal arm (Figure 4). Due to the ice drift, the radar gauge can be operated only seasonally, in the Antarctic summer. Therefore, the arm must be assembled and disassembled using an auxiliary construction (Figure 5). During one season, the mounted arm has one stable position. During next season, the arm has a stable position too, but it is another one, especially in the height. This is not a problem because the position is calculated by GPS.

Problems, Experiences, Solutions

Disturbance echoes by fault mount:

After installing the radar gauge, we could see some faulty data especially in winter in Sassnitz. In case of rough water surface, the reflected radar impulse was weaker compared with earlier signals. Therefore, the strength of the reflected signal from the pier was in the same order of magnitude as the signal from the water surface. By using a robust filtering (median), it was possible to achieve useful results from the recorded data. In order to prevent such disturbance echoes the metal arm was extended by 0.5 m to have the guarantee that beam does not touch the pier.



Figure 4 Mount of the radar gauge at the cliff edge in GARS O'Higgins.



Figure 5 Auxiliary construction (yellow) for assembly and disassembly of the radar gauge arm in GARS O'Higgins.

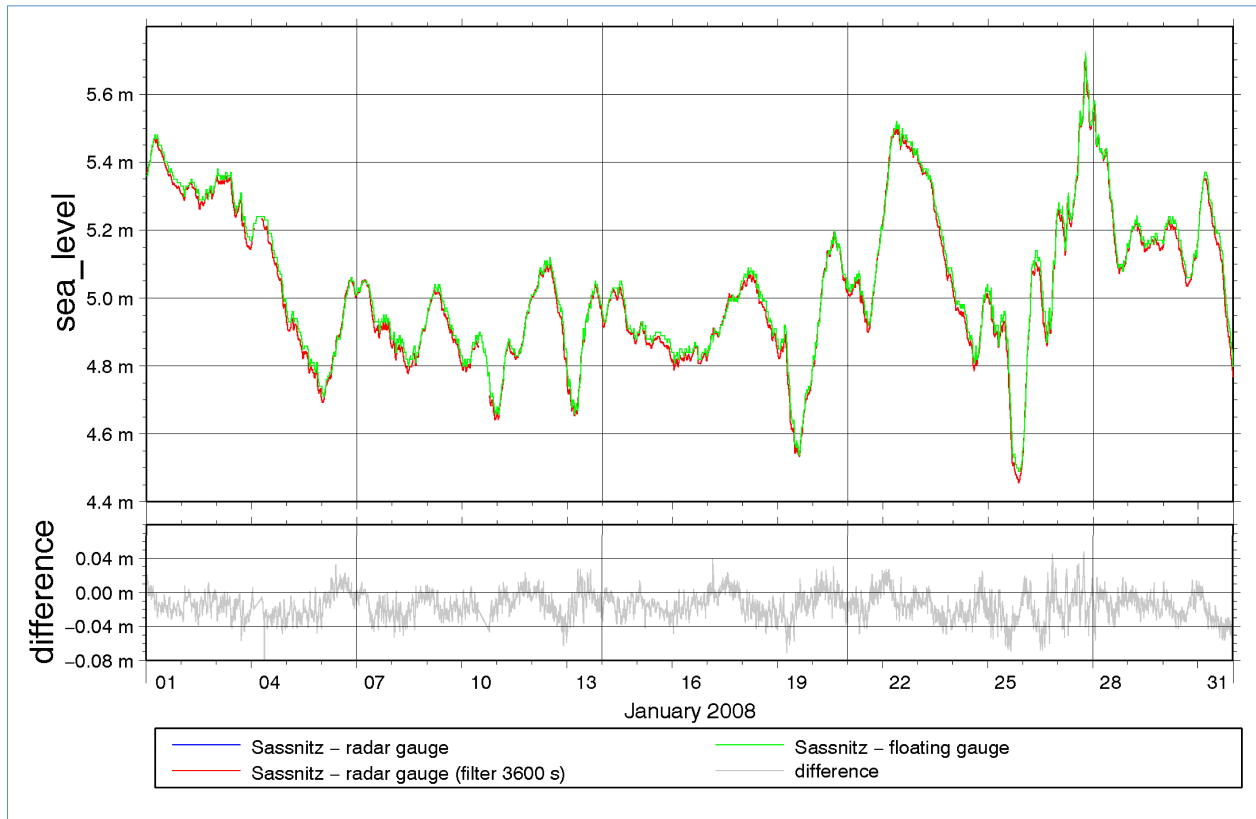

Figure 6 Comparison of the measured values of the radar gauge with those of the official floating gauge in Sassnitz in January 2008 (Liebsch et al., 2008).

Disturbance echoes by spray:

In case of storm (often in Antarctica) and strong surge, the water surface is extremely rough. Spray is splashing up to the radar gauge. Then the measurement values are invalid, they vary significantly (**Figure 8**). A similar problem occurs when the radar gauge is iced. Then it measures a constant distance of a few centimeters for all the time the ice is still around the horn antenna. In these cases, we have to remove the recorded data in the analysis process.

Comparison of radar gauge with float gauge (stilling well):

The hydrograph of water level measured by the radar gauge and by the official floating gauge has the same characteristics (Liebsch et al., 2008) (**Figure 6**). After calculating the differences, the values of the measurement systems differ up to 20 mm from each other. This is based on the different measure methods. Within the stilling well of the conventional gauge the water level is smoothed physically. Thus, there is a time delay (phase error) of the measurement signal, which is dependent on the mechanical damping/absorption. The radar gauge collects data every 5 seconds. A mathematical filter with

a very tiny phase error makes the smoothing/absorption. **Figure 7** shows such phase delays.

Influence of salt water:

The radar gauge VEGAPULS 62 is directly in the influence of salt water and it is exposed to the harsh climatic conditions in Antarctica. This device worked without any mistake all the time, we had no problem with this sensor.

The GPS antenna on top of the radar gauge is also directly in the influence of salt water. With the antenna TPS PG-A5 we had multiple problems with the plug. Salt water had penetrated and damaged the pins of the plug and made a short circuit. By using very special heat-shrinkable tubing the problem was solved.

Furthermore, the salt water damaged/corroded the ground plane of two TPS PG-A5 antennas. In 2015, we installed the navXperience 3G+C antenna. According to the manufacturer, this antenna should be particularly well suited to local Antarctic conditions. So far, this statement has been confirmed. We have had good experiences with this antenna.

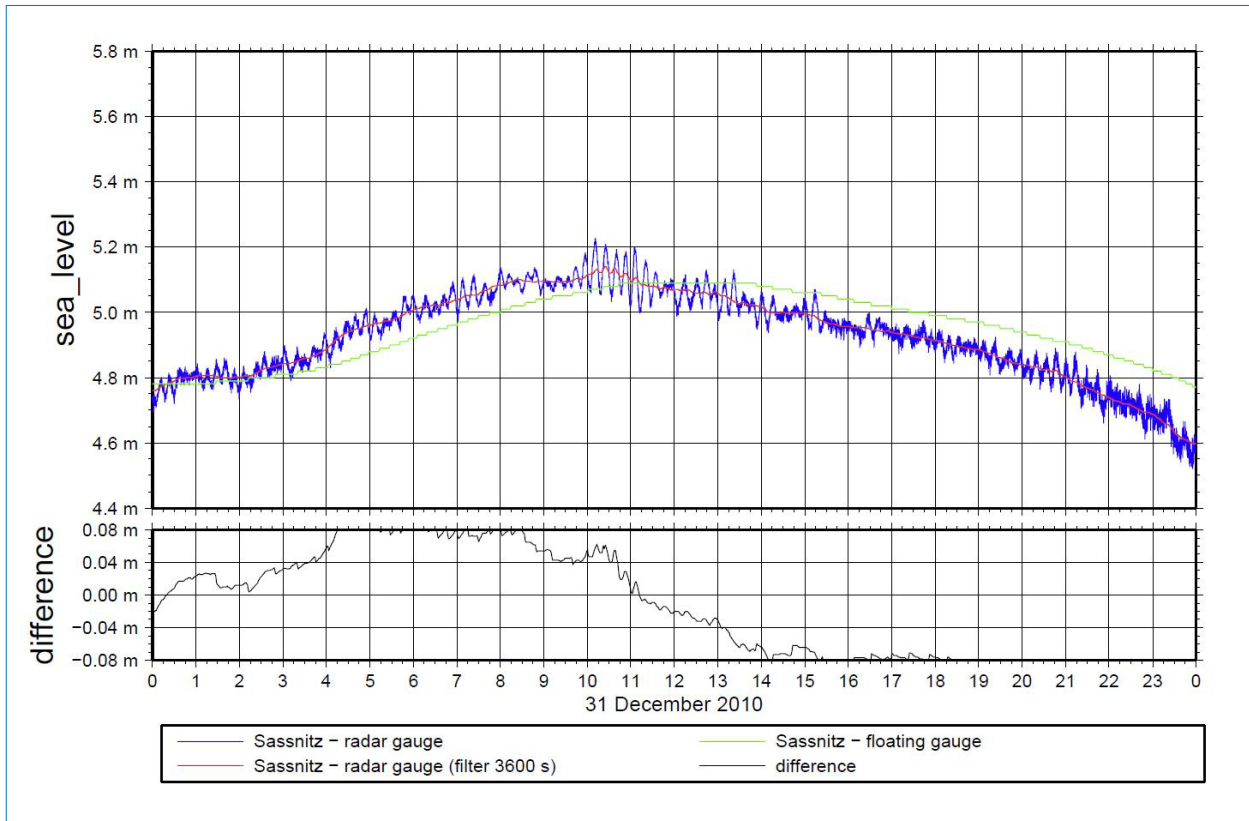

Figure 7 Comparison of the measured values of the radar gauge with those of the official floating gauge in Sassnitz, representation of the phase delay in the measurement values of both gauges.

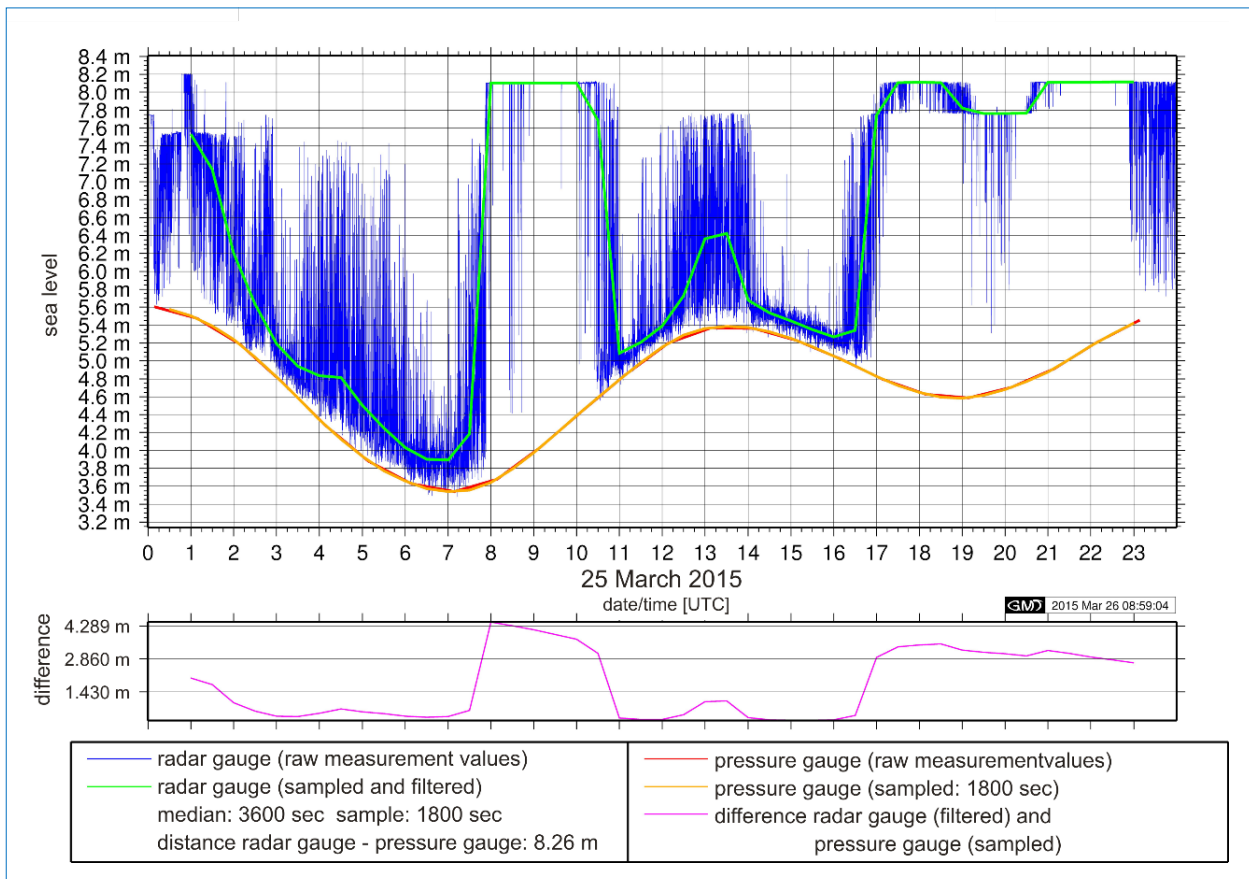

Figure 8 Example for time series of the radar gauge with invalid values because of spray splashing on up to the radar gauge in GARS O'Higgins.

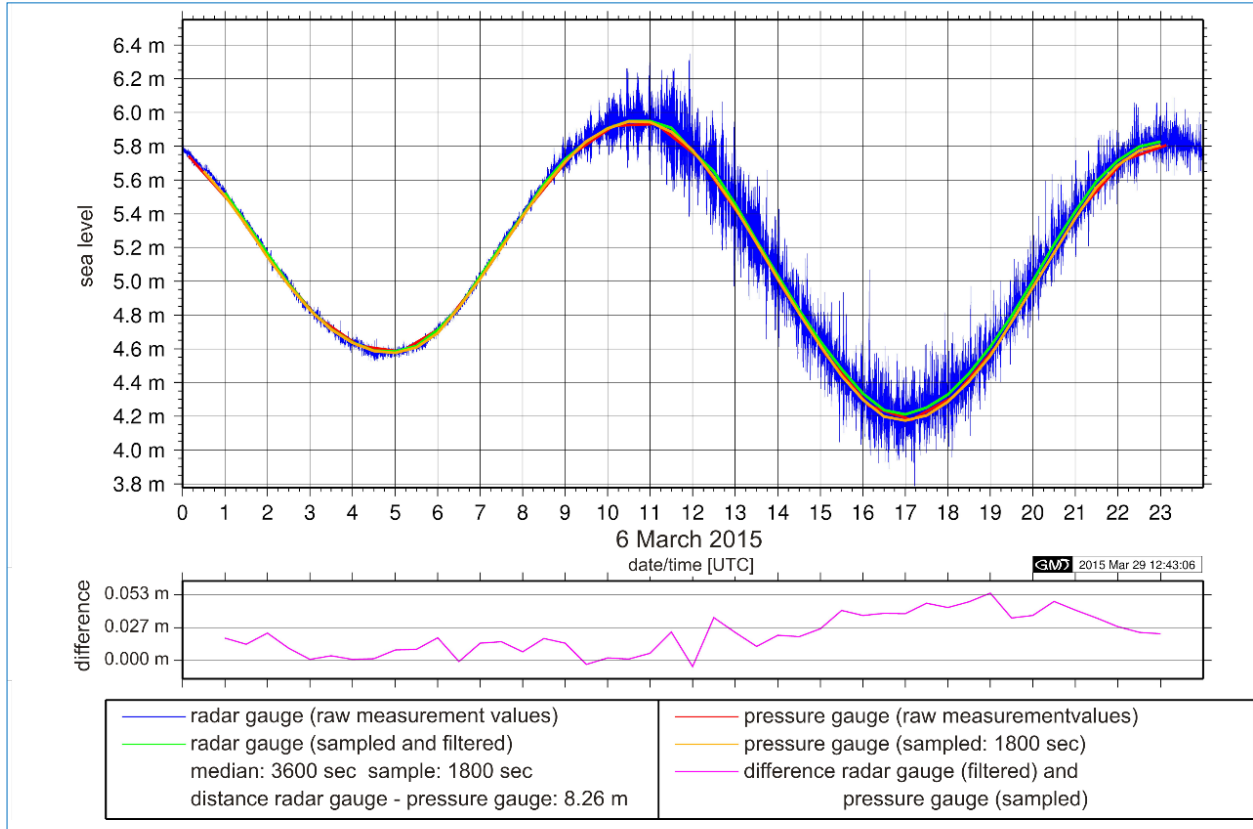

Figure 9 Example for time series of the radar gauge with widely varying values due to rough seas and strong swell in GARS O'Higgins. Filtering leads to useful results from the recorded data.

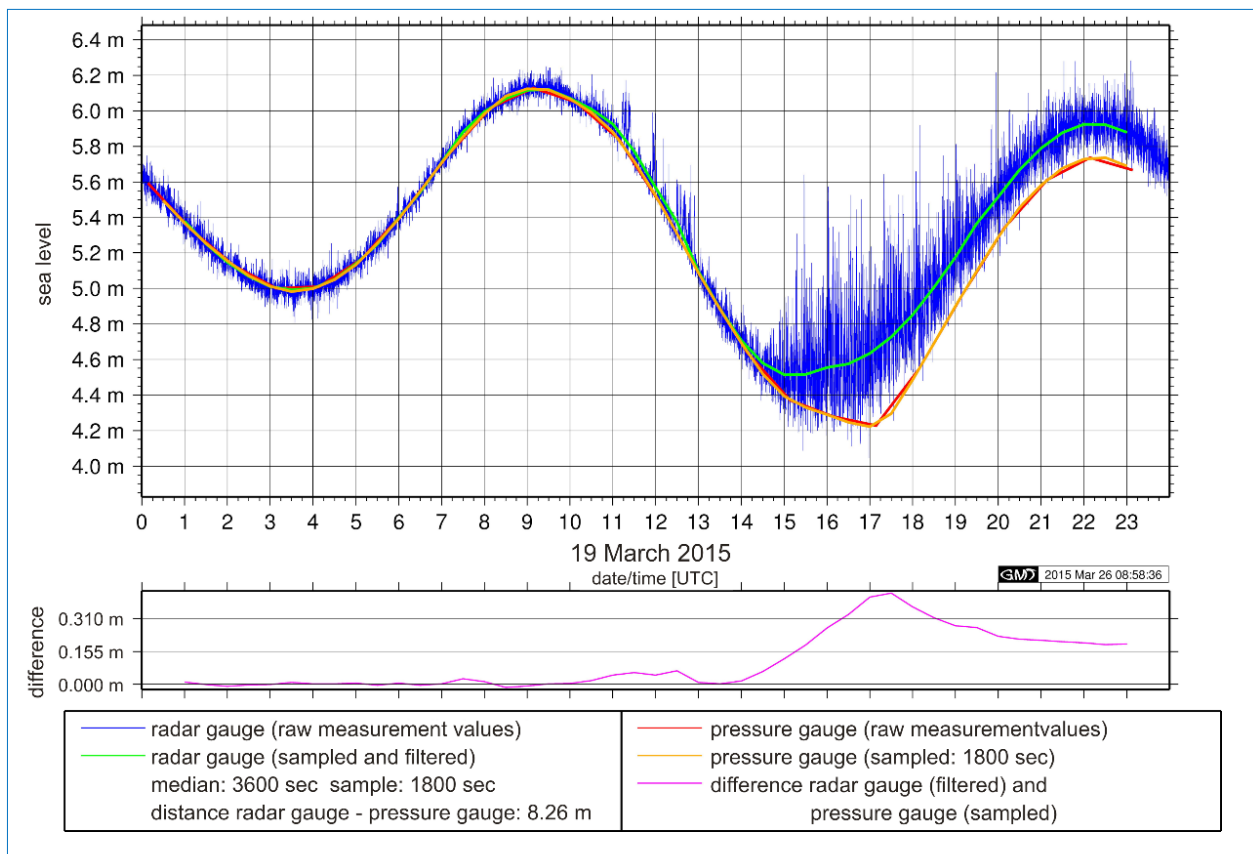

Figure 10 Example for time series of the pressure gauge and the radar gauge in GARS O'Higgins. You can see a vertical displacement of the pressure gauge. The height position of the radar gauge is GPS controlled. In this case, the reason for the displacement of the pressure gauge could be determined, a small iceberg that scraped over the bottom and took the pressure gauge a little bit with it.

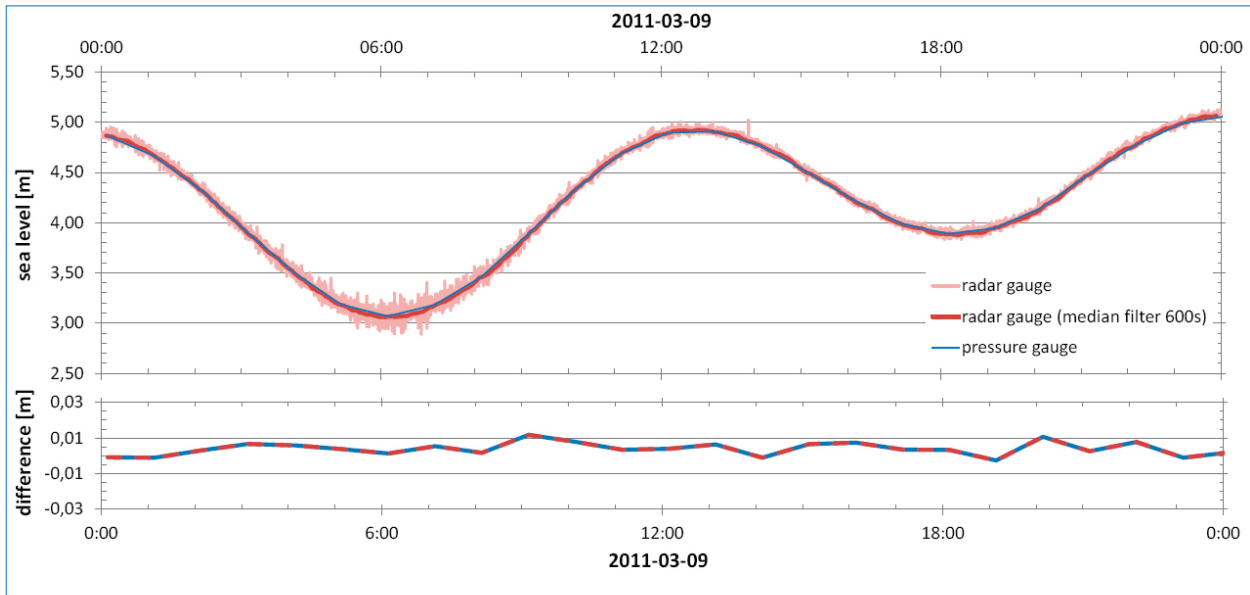

Figure 11 Example for time series of the pressure gauge and the radar gauge (filtered) in GARS O'Higgins.

Influence of waves:

In rough seas and strong swell, the radar gauge measurement values vary widely, but they are around the correct average value. By using a robust filtering (median), it is possible to achieve useful results from the recorded data (Figure 9).

Choosing suitable devices and cables:

The VEGAPULS 62 is an industrial gauge developed for the chemical industry. Thus, it is very suitable for extreme environmental conditions like spray of salt water.

It is important to choose a suitable cable from the radar gauge to the connected equipment. It has to be salt water resistant, UV resistant and suitable for the low temperatures. We use at GARS O'Higgins the cable "Ölflex" cable 550P 3G1,5".

The distance from the radar gauge to the container with the other measurement equipment is about 100 meters at GARS O'Higgins. All cables and devices have to be suitable for such a long distance.

Position of the radar gauge:

The position of the gauge near to the cliff edge at GARS O'Higgins is not ideal. Because of the surge, we have systematic measurement error.

Zero point change detectable by Radar Gauge:

The radar gauge measurement can be used to control the height position of the pressure gauge directly (next day

in our case). The GPS data of the antenna on top of the radar gauge must be analyzed simultaneously to make the decision what gauge moved. Figure 10 shows the shift in height of the absolute pressure gauge at GARS O'Higgins. In this case, the reason for the displacement of the pressure gauge could be determined. Colleagues on site saw a small iceberg that scraped over the bottom. It took the pressure gauge a little bit with it and finally, the gauge lies about 20 centimeters higher than before.

Comparison of radar gauge with float gauge:

Time series of the pressure gauge and the radar gauge (filtered) are in very good agreement; they have the same characteristics. This allows a precise and reliable determination of the distance between the GPS antenna and the pressure gauge (→ tide gauge zero level). (Figure 11)

○ Summary

The radar gauge technology as well as the specific radar gauge device VEGAPULS 62 is very suitable to measure the water level in harbor and at the coast of the open sea. For measurements at the coast on the open sea, there are small limitations when spray occurs.

The radar gauge is very flexibly usable and measures accurately. VEGAPULS 62 is suitable for harsh environmental conditions.

The combination of radar gauge with GPS on top of the gauge and GNSS reference station nearby has been



Figure 12 New GNSS reference station in Sassnitz (GREF station SAS2) with GNSS antenna on top of the antenna pillar, control unit, weather measurement unit and Radar Gauge (in operation since April 2016).

implemented and used very successfully. We appreciate this combination.

The radar gauge was compared with other gauges with different measuring principle. We found a fundamental match of the hourly averaged values in the cm range.

The radar gauge in combination with GPS/GNSS acts as a virtual “tide pole” to control other gauge sensors.

Finally, we can point out that we like our radar gauges best.

○ References

Liebsch, G. and Blasi, C. J. 2008. Einsatz eines Radarsensors und GPS-Empfängers am Pegel Sassnitz

http://www.bafg.de/DE/08_Ref/M1/04_Aktuelles/kurzber_radar_gps_sassnitz.html (2015-03-27 12:30 UTC)

○ List of Abbreviations

BKG	Bundesamt für Kartographie und Geodäsie Federal Agency for Cartography and Geodesy, Germany
GARS	German Antarctic Receiving Station
GNSS	Global Navigation Satellite System
GPS	Global Positioning System
GREF	Integrated Geodetic Reference Network of Germany (operated by BKG)
IERS	International Terrestrial Reference System
IGS	International GNSS Service
NOAA	National Oceanic and Atmospheric Administration (USA)
WSA	Wasser- und Schifffahrtsamt (Waterways and Shipping Office)

*Experience with
Downward-looking Aerial Microwave
Radar Based Sea-level Gauges deployed
along Indian Coasts and Islands*

Prakash Mehra, R.G. Prabhudesai*, Antony Joseph*, Vijay Kumar,
Yogesh Agarvadekar, Ryan Luis, M. Soumya, Bharat Harmalkar, and
Devika Ghatge
CSIR-National Institute of Oceanography (CSIR-NIO), Goa, India

* Retired Scientist

Contact: P. Mehra
E-mail: pmehra@nio.org

○ Abstract

Subsequent to the disastrous December 2004 Indian Ocean tsunami event, near real-time reporting integrated coastal observation network (ICON) providing sea-level, sea-state and surface meteorological information has been developed and established by CSIR-NIO at selected locations on Indian coasts and Islands. Sea-level data are obtained from several remote and coastal locations using downward looking aerial microwave based radar gauges. Apart from monitoring long term sea-level variations at a particular location, the internet-based ICON could be useful in near real-time tracking and monitoring of sea-level, sea-state and surface-meteorological conditions from a network of several island and coastal stations providing the much needed information to disaster managers and local administrators during episodic events such as storms, storm-surges and tsunamis.

○ Introduction

Sea-level, sea-state and surface meteorological data are of considerable value to the research community in a variety of applications for a wide range of scientific studies including those of long-term changes and the statistics of extreme events. Long-term changes in atmospheric warming and global mean sea-level due to climate change continues to be the focus of much research in recent years because of the potential impacts on the environmental, economic, and social infrastructure at the coasts and islands. Considering the vulnerability of the Indian coasts and islands to storm surges and the recently felt threat of tsunamis, including the powerful December 2004 global tsunami (Titov et al., 2005; Joseph et al., 2006) near real-time reporting of sea-level, sea-state, and surface meteorological information has become all the more important for multi-hazard monitoring and early-warning purposes. Thus, establishment of a network of near real-time reporting sea-level, sea-state and surface meteorological stations providing high-quality data sets will lead to improved operational utilities and more efficient forecasting results (Joseph and Prabhudesai, 2005). Further, good quality data availability will facilitate promotion of oceanographic and climatologic research programmes to improve understanding of critical global and regional ocean- and climatologic- processes and their relationship to the sustainable development and stewardship of ocean resources.

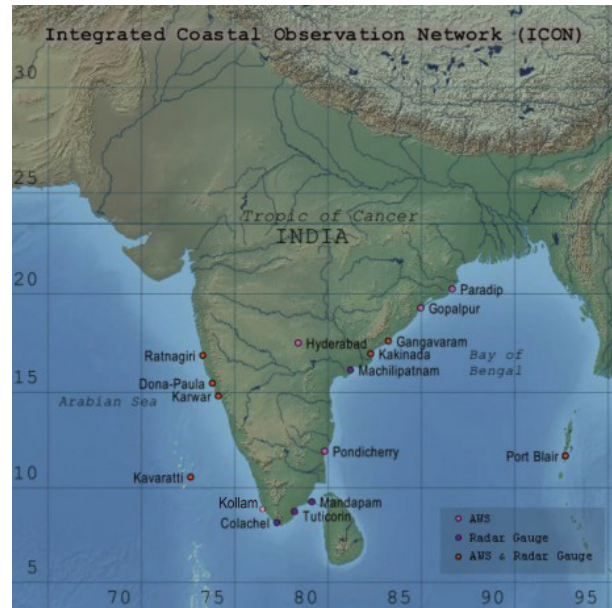

Figure 1. Radar based sea-level gauges and autonomous weather stations installed along the Indian coasts and islands.

The December 2004 Indian Ocean tsunami caused heavy damage to life and property, which led to serious efforts towards development and establishment of related technologies to monitor sea-level, tsunamis, storm surges and high waves. CSIR-NIO also joined in this endeavor by developing an internet enabled sea-level gauge capable of providing information in near real-time (Prabhudesai et al., 2006). The first such in-house designed and developed sea-level gauge using an absolute pressure sensor (Honeywell Inc.) was deployed at Verem Jetty, Goa in September 2005. Later on another sea-level gauge using OTT Kalesto downward looking microwave based radar sensor was installed in Verem Jetty in September 2007. Steadily, the number of field stations increased and also most of these sites have been complemented with in-house designed and developed autonomous weather stations (NIO-AWS). In this paper, we report the experience gained in developing and operating an in-house designed internet-accessible, cellular based, near real-time reporting sea-level, sea-state and surface meteorological system known as Integrated Coastal Observation Network (ICON) established by the CSIR-National Institute of Oceanography, Goa, India, at several locations on the Indian coasts and Islands as shown in **Figure 1** (Prabhudesai et al., 2010). The data acquired by ICON is also upload at <http://inet.nio.org> for the benefit of various stakeholders.

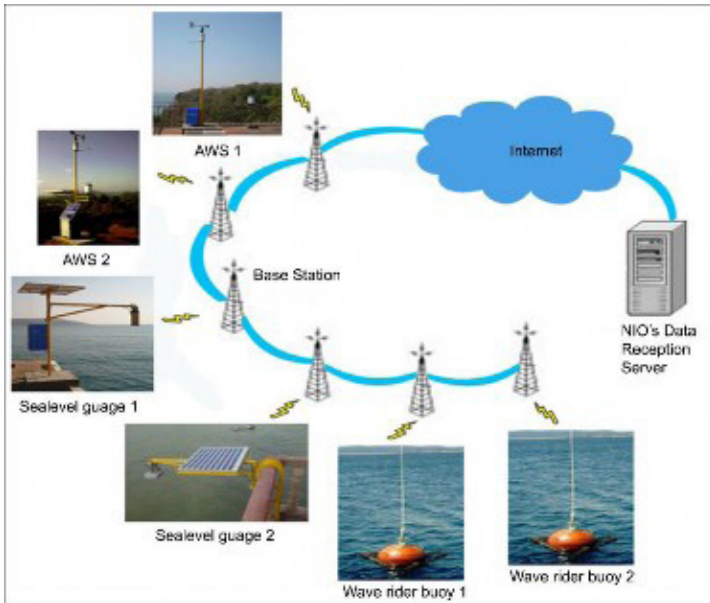

Figure 2. Schematic illustration of the network of distributed near real-time reporting sea-level, sea-state and surface meteorological stations.

(AWS), sea-level gauges and wave rider buoy as shown in **Figure 2** are incorporated in the ICON. **Figure 3** shows some of the typical installations at different locations using microwave radar sensor. The sea-level and surface meteorological data are acquired using dedicated Linux based data loggers and uploaded to an Internet server at 5- and 10-min intervals respectively, with the use of GPRS cellular modems. The sensors and data loggers are powered from sealed lead acid batteries, which are charged through solar panels (**Figures 2 and 3**).

The ICON provides graphical presentation of sea-level information (observed sea-level, predicted tide, sea-level residual) and surface meteorological information (such as vector-averaged wind speed & direction, barometric pressure, atmospheric temperature, relative humidity, solar radiation and rainfall). The network maintains accurate time-stamp of the dataset through Internet-time synchronization using network time protocol (NTP). Recently, the sea-level gauges and AWS are also provided with a GPS receiver to update the time in case internet network is not available.

○ Integrated Coastal Observation Network (ICON)

The in-house designed and developed Internet-accessible near real-time reporting cellular based sea-level, sea-state, and surface meteorological (Met) stations deployed at several locations on the Indian coasts and Islands has been described in detail by Prabhudesai et al. (2010). The network of autonomous weather stations



Figure 3. Typical installations of microwave based radar gauges at [a] Karwar, [b] Port Blair and [c] Dona Paula.

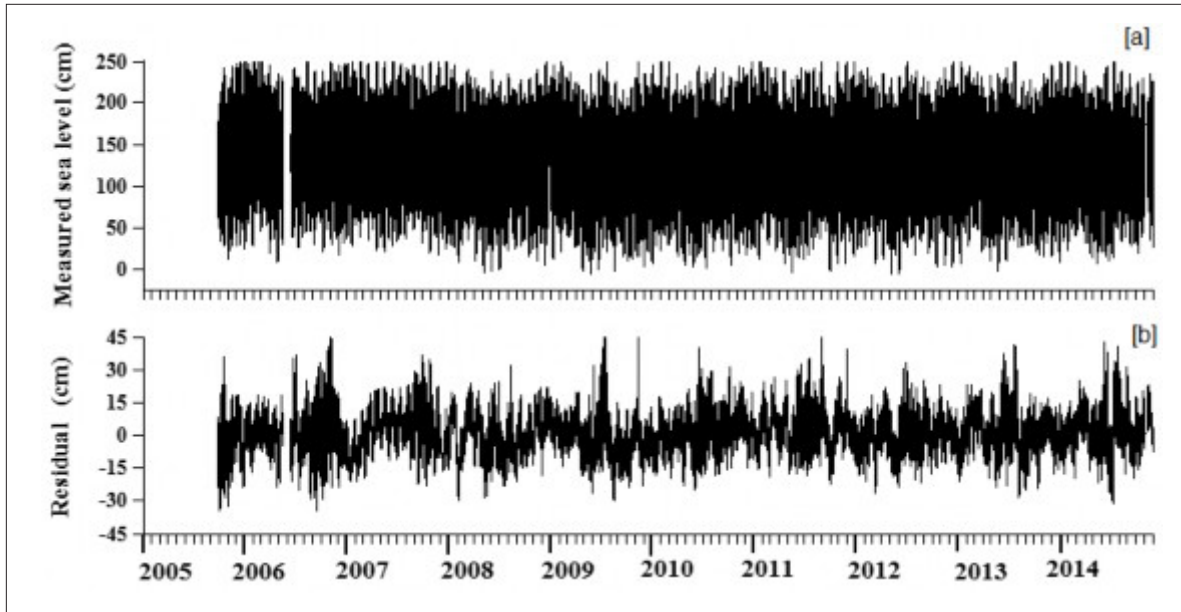

Figure 4. Time series measurement at Verem, Goa from September 2005–December 2014. [a] Sea-level. [b] Estimated sea-level residual.

○ Results

Sea-level measurements by pressure and radar gauges from September 2005 - December 2014, the longest time series data available under ICON from Verem, Goa is shown in **Figure 4**. The tidal range is up to 250 cm with fortnightly variation in spring and neap tides (**Figure 4[a]**). The tides off Verem have a 'form factor' of 0.64, implying that the tides are mixed, mainly of semi-diurnal nature (Murty and Henry, 1983). When the tidal signal was removed from the sea-level records using the TASK (Bell et al., 2000) tidal analysis and prediction algorithm, sea-level residuals (SLR) are estimated as shown in **Figure 4[b]**. The sea-level residual at Verem varies between ± 40 cm with a variance of ~ 70 cm². The continuous measurement of sea-level data has been made possible due to the reliability of the radar sensor and the in-house development of electronics, software and mechanical hardware, resulting in the minimum downtime of the system.

Comparison between radar and pressure gauges

The first comparative study between the radar and pressure gauge at Verem was reported by Mehra et al., 2009 using data from September 2007 to April 2009. It was observed that the variance of difference between the radar and absolute pressure gauge was 15.9 cm², which reduces to 5.7 and 4.0 cm² respectively, when atmospheric pressure and water density variations were introduced for obtaining sea level from an absolute pressure gauge. Later, more comparative analyses were

carried out using sea-level data collected off Goa using near real-time reporting pressure (Honeywell Inc.) and radar gauges at Verem, located near the mouth of the Mandovi estuary (January 2009 to May 2010), Tuticorin, and Mandapam (Sea-Bird Electronic), Tamil Nadu (June 2010 to March 2011) by Mehra et al., 2013 as shown in **Figure 5**. The root-mean-square difference between the estimated sea level from radar and pressure gauge (incorporating atmospheric pressure correction) was 2.69, 2.73, and 1.46 cm at Verem, Tuticorin, and Mandapam, respectively. Harmonic analysis of the two time-series of sea-level data at Verem produced similar residuals (**Figure 5 [c] and [d]**). The monthly variability as shown in **Figure 6** was with negligible difference. The high residual variability (~ 163 cm²) seen in November 2009 is the response of the sea-level to the tropical cyclonic storm 'Phyan', which developed in winter in the south-eastern Arabian Sea and swept northward along the eastern Arabian Sea during 9–12 November 2009 as reported by Joseph et al., 2010.

Comparison with altimeter and GPS buoy at Kavaratti

Installation of four radar gauges at Kavaratti, Colachel, Machilipatnam and Port Blair were funded by Space Application Centre (SAC), Ahmedabad, India from June 2011 for three years duration where the footprint of the altimeter (SaraI-Altika in particular) passes. During the measurement period, the calibration/validation (CAI/Val) experiment was conducted at Kavaratti Island during 1-5 October 2012 jointly by SAC, Ahmedabad, CSIR-NIO,

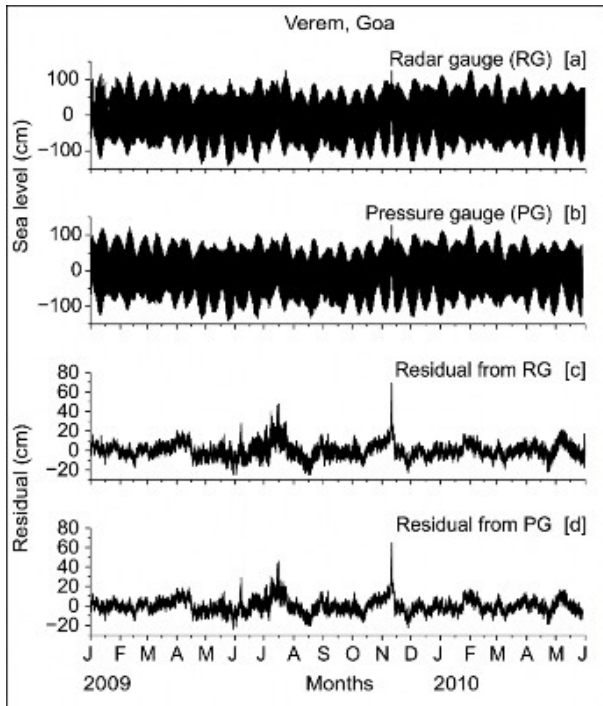

Figure 5. Sea level measurements at Goa using [a] radar gauge (RG), [b] pressure gauge (PG) and respective residuals [c] from RG and [d] PG (Mehra, et al., 2013).

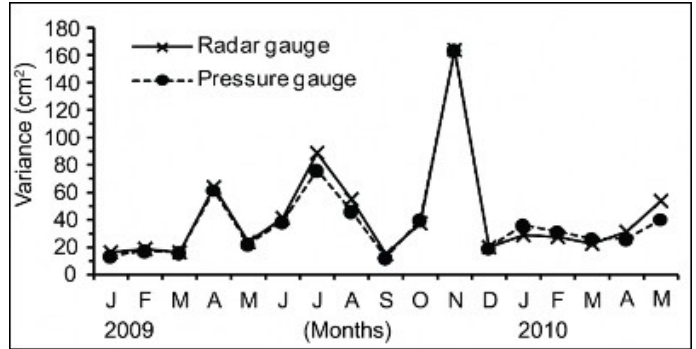

Figure 6. Seasonal sea level residual variability at Verem Goa (Mehra et al., 2013).

Goa and CNES, France with the main objectives of the experimental setup as indicated below:

- ✓ To find a place and install a dedicated cal/val radar gauge.
- ✓ To show, train and use the GPS-Buoy for cal/val in India.
- ✓ Conduct the first GPS-Buoy session over a Jason2-Altika cross-over point.
- ✓ Connect each instrument through traditional leveling.

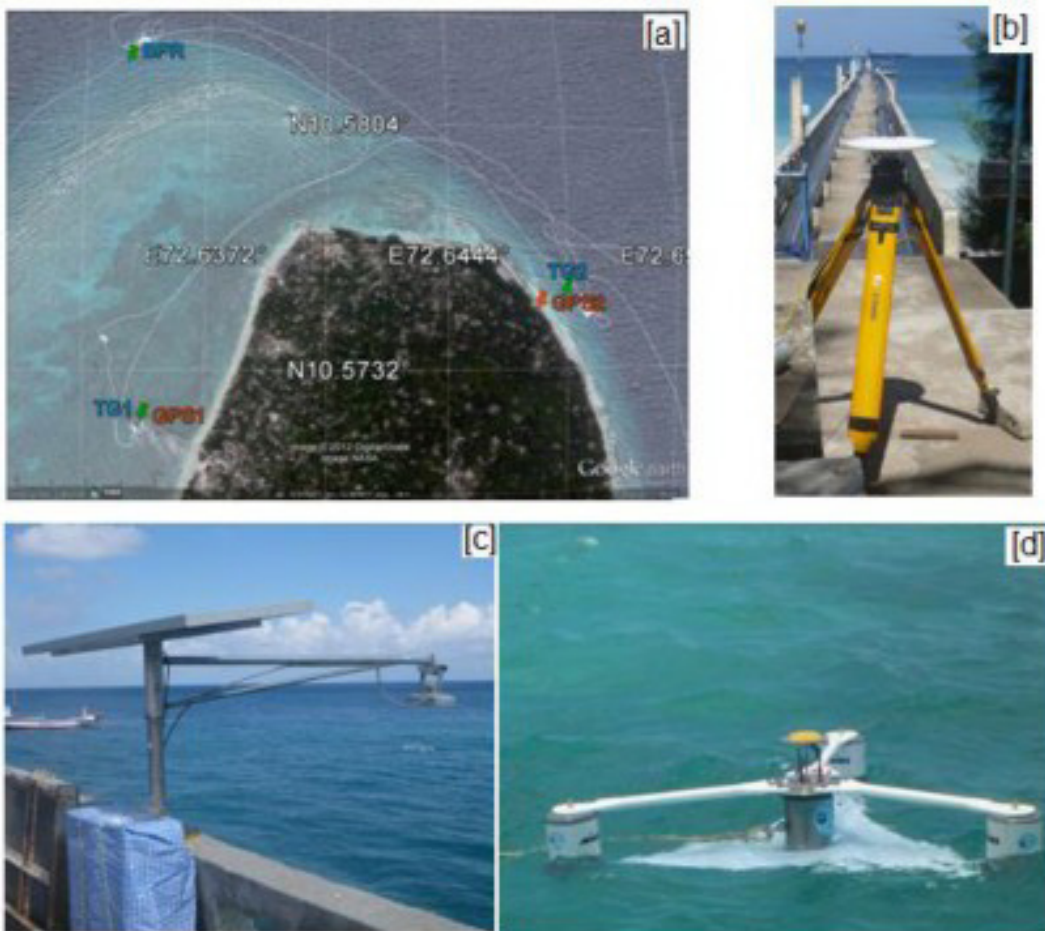

Figure 7. [a] Experimental setup and instruments deployed during the Cal/Val experiment at Kavaratti (1-5 October 2012). [b] GPS Base station, [c] Radar gauge (TG2) and [d] GPS buoy (GPS2) deployed at NIOT jetty.

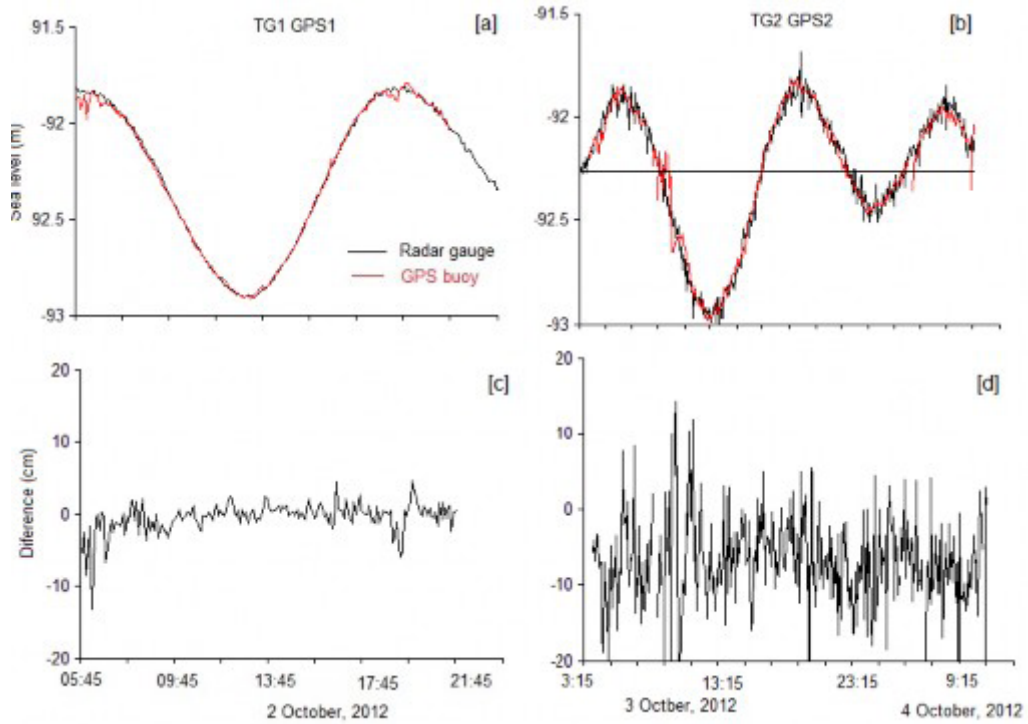

Figure 8. GPS buoy comparison with radar gauge at [a] Katchery (main) jetty, [b] NIOT Jetty. Difference (GPS buoy-Radar gauge) at [c] Katchery main and [d] NIOT jetty.

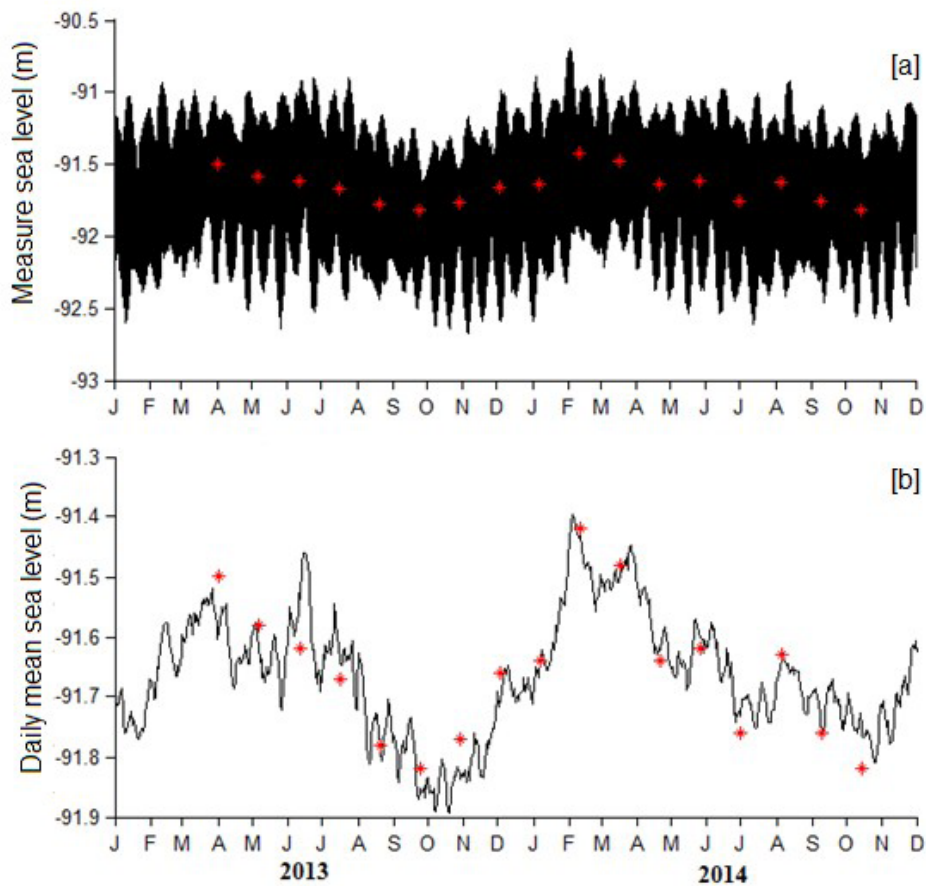

Figure 9. [a] Sea-level at 5-minutes interval and [b] Daily-mean sea level data from radar gauge (black line) and sea surface height from Saral-Altika altimeter (red stars) with reference to ellipsoid at Kavaratti [Time is in GMT].

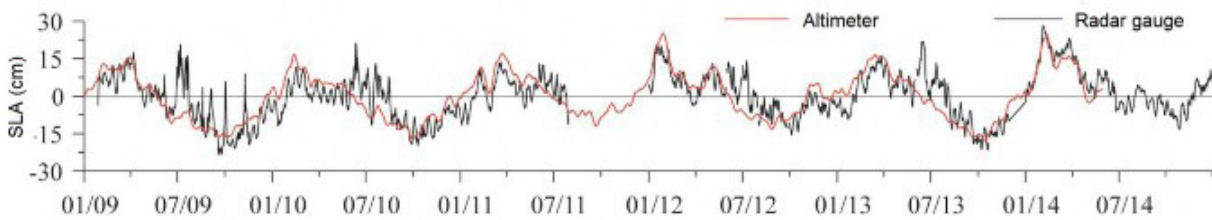

Figure 10. Daily mean sea-level anomaly measured by radar gauge (Black line) at kavaratti along with the Merged and gridded products of MSLA (Maps of Sea Level Anomaly, Red line) from 2009-2014. The data derived from satellite altimeter (<https://www.avisioceanobs.com.SLA>) is produced by AVISO (Archiving, Validation, and Interpretation of Satellite Oceanographic data), based on TOPEX/Poseidon, Jason 1, ERS-1 and 2 altimeter observations. Daily resolution SLAs for Kavaratti is extracted from the gridded product of MSLA.

This experiment was initiated by Dr. P. Bonnefond (OCA/CNES) and organized by Dr. A.K. Shukla (ISRO/SAC) in the frame of the Indo-French “SARAL/AltiKa” collaboration. CSIR-NIO provided the radar gauges and the French team was led by L. Testut (LEGOS/CSIR-NIO), M. Calzas and A. Guillot (DT/INSU) were responsible for GPS buoy and mooring deployment.

In this report, we present the preliminary results from the Kavaratti Island only. The experimental setup at Kavaratti is shown in **Figure 7**, where radar gauges and GPS buoys were installed/deployed at Katchery main Jetty (TG1 and GPS1) and at NIOT jetty (TG2 and GPS2) as shown in **Figure 7[a]**. **Figure 7[b]** show the temporary GPS base station at NIOT jetty for leveling of the radar gauges with respect to the ellipsoid. The radar gauge (TG2) and the GPS buoy (GPS2) installed/deployed at/near NIOT jetty are shown in **Figure 7[c-d]**. Similar setup was installed/deployed at Katchery main jetty also. Preliminary results obtained between the radar gauges and GPS buoy at Kavaratti are shown in **Figure 8**. The GPS buoy (GPS1) comparison on 2nd October 2012 at Katchery (main) jetty with radar gauge (TG1) after removing the offset is shown in **Figure 8[a]**. Similarly, **Figure 8[b]** shows the GPS buoy (GPS2) comparison on 4th October 2012 at NIOT jetty radar gauge (TG2) after removing the offset. The standard deviation in difference between GPS and radar gauge at Katchery main (NIOT) jetty is 3.8 (6.2) cm as shown in **Figure 8[c-d]**. The radar gauge station at Katchery (main) jetty is located in a shallow lagoon, because of which wave activity surrounding this station is weak. However, the NIOT Jetty is located in a region of high wave activity. This explains the relatively large noise observed in the measurements from the NIOT Jetty. The experiment can be considered as a satisfactory initiative to make Kavaratti a cal/val site for future use.

The sea-level measured by the radar gauge (black line) every 5 min are shown along with the sea surface height (SSH) measured by Saral-Altika altimeter (red stars) in **Figure 9** at Kavaratti. The Saral-Altika data is available every ~35 days at a particular location. The altimeter data appears to vary along the mean value and are within the sea level range (**Figure 9[a]**). **Figure 9[b]** shows the daily-mean sea level (black line) and the Saral-Altika altimeter data (red stars) at Kavaratti with similar variations as the daily-mean sea level. **Figure 10** shows the daily mean sea-level data measured by radar gauge at Kavaratti along with the gridded daily sea level anomaly derived from altimeters from 2009-2014 with illustrating similar variations with a correlation coefficient of ~0.73.

○ Summary and conclusions

The development of ICON of sea-level gauges and AWS was initiated in the year 2005, immediately after the occurrence of December 2004 Sumatra tsunami and the first near real-time reporting sea-level gauge based on pressure sensor was installed at Verem (Mandovi estuary), Goa in September 2005. However, presently all our sea-level stations use radar sensor. The radar based sea-level gauges deployed under ICON measures the sea-level in a completely different way than the traditional float or bubbler gauges. The ICON is developed with simple supporting structure to mount the sensors, powered by solar energy, and communicating data (using cellular modems) automatically to a web server located at CSIR-NIO, Goa. The system does not need expensive infrastructure, such as stilling-well, intake pipes or cabins, normally seen in ports. However, these features could present some drawback, if the sites are exposed to harsh environment and lacks security. With prior survey of the sites, the drawback of harsh environments and security

aspects are minimized and we, therefore, have been able to operate the network of such stations (see <http://inet.nio.org/>) successfully since September 2005.

The ICON enable us to study the response of sea-level to various meteorological and tsunamigenic events along the Indian coasts and Islands. The sea-level gauges at Verem and Kavaratti Island enabled real-time monitoring of the tsunami at Goa and Kavaratti Island due to the Mw 8.4 earthquake in Sumatra on 12 September 2007 (Prabhudesai et al., 2008). In particular, sea-level gauges, surface meteorological instruments and wave-rider buoys in the network enabled real-time monitoring of the response of west India coastal waters and Kavaratti lagoon to the November 2009 tropical cyclone Phyan (Joseph et al., 2010). The ICON also enabled Mehra, et al. (2012) to examine the observed storm-generated sea-level oscillations (June 2007 and November 2009) along with the Sumatra geophysical tsunami (September 2007), indicating similarities in the sea-level response in the Mandovi estuary of Goa in the eastern Arabian Sea. Likewise, Mehra et al. (2015) investigated the meteorologically induced surges and water level oscillations along select locations in response to the passage of the November-2011 meteorological disturbance in the Arabian Sea and "Thane" storm in Bay of Bengal. The high frequency water level oscillations were observed at Gangavaram (east coast of India) during the events and were found to have been due to the result of harbour resonance.

Several research institutions and universities are gaining mileage from this network in terms of data usage. For example, apart from usage at national level, Titov et al. (2011) used time-series sea-level data from Yanam station (on the east coast of India) in the ICON network to test their newly developed tsunami inundation software package (Community Modeling Interface for Tsunamis-ComMIT) during a weak tsunami triggered by an earthquake in Andaman Islands. In their published research paper, they have specifically mentioned the value of the ICON network and cited the paper published on the ICON (Prabhudesai et al., 2010).

Presently, there are only a few mesoscale weather and sea-level networks in some coastal segments of the Indian and eastern Atlantic oceans to observe such events. It is also expected that this kind of relatively inexpensive and simple networks, similar to the one developed in-house

and established by CSIR-NIO will be affordable to limited-budget institutions in their natural hazard mitigation efforts.

○ Acknowledgments

The authors acknowledge the support and encouragement provided by former directors Dr E. Desa, Dr S.R. Shetye, Dr S.W.A Naqvi and the present acting director Dr Prasanna Kumar S., CSIR-NIO, Goa in carrying out this work. They are grateful to Anil Shirgoankar for his consistent technical support in keeping the systems operational. The authors acknowledge the support of Finolex Industries Limited, Ratnagiri, Maharashtra; Indian Naval Office at Verem, Goa; Estuary View Resort and Survey of India office, Karwar, Karnataka; CSIR-CECRI, Tuticorin, Tamil Nadu; CMFRI, Mandapam, Tamil Nadu; Kakinada Seaports Ltd., Kakinada, Andhra Pradesh; Gangavaram Ports Limited, Visakhapatnam, Andhra Pradesh, and Gopalpur Ports Limited, Odisha for providing safe and secured site for sea level and surface meteorological measurements.

○ References

- Bell, C., Vassie, J.M. and Woodworth, P.L. (2000), Tidal Analysis Software Kit 2000 (TASK-2000). POL/PSMSL Permanent Service for Mean Sea Level, Proudman Oceanographic Laboratory, UK.
- Joseph, A., and Prabhudesai, R.G. (2005), Need of a disaster alert system for India through a network of real time monitoring of sea level and other meteorological events. *Curr. Sci.*, 2005, 89 (5), 864-869.
- Joseph, A., Odametey, J.T., Nkebi, E.K., Pereira, A., Prabhudesai, R.G., Mehra, P., Rabinovich, A. B., Kumar, V., Prabhudesai, S., and Woodworth, P.L. (2006), The 26 December 2004 Sumatra tsunami recorded on the coast of West Africa. *African J. of Marine Sci.* 2006, 28(3&4), 705-712.
- Joseph, A., Prabhudesai, R.G., Mehra, P., Sanil Kumar, V., Radhakrishnan, K.V., Vijay Kumar, Ashok Kumar, K., Agarvadekar, Y., Bhat, U.G., Luis, R., Rivankar, P. and Viegas, B. (2010), Response of west Indian coastal regions and Kavaratti lagoon to the November-2009 tropical cyclone Phyan. *Natural Hazard*, DOI 10.1007/s11069-010-9613-7, Sept., 2010.
- Mehra, P., Desai, R.G.P., Joseph, A., VijayKumar, K., Agarvadekar, Y., Luis, R., Sundar, D. and Viegas, B. (2009), A one year comparison of radar and pressure tide gauge at Goa, west coast of India, Proceedings of the International Symposium on Ocean Electronics (SYMPOL-2009), 18-20 November 2009, 173-183.

- Mehra, P., Desai, R.G.P., Joseph, A., Vijaykumar, K., Agarvadekar, Y., Luis, R., Viegas, B., A study of meteorologically and seismically induced water level and water temperature scillations in an estuary located on the west coast of India (Arabian Sea), *Nat. Hazards Earth Syst. Sci.*: 12; 2012; 1607-1620.
- Mehra, P., Desai, R.G.P., Joseph, A., Vijaykumar, K., Agarvadekar, Y., Luis, R. and Nadaf, L., Comparison of sea-level measurements between microwave radar and subsurface pressure gauge deployed at select locations along the coast of India, *J. Appl. Remote Sens.*: 7(1); 2013; 16pp., doi: 10.1117/1.JRS.7.073569.
- Mehra, P., Soumya, M., Vethamony, P., Vijaykumar, K., Nair, T.M.B., Agarvadekar, Y., Jyoti, K., Sudheesh, K., Luis, R., Lobo, S., and Halmalkar, B, Coastal sea level response to the tropical cyclonic forcing in the northern Indian Ocean, *Ocean Sci.*: 11(1); 2015; 159-173.
- Murty, T.S. and Henry, R.F. (1983), Tides in the Bay of Bengal, *J. Geophys. Res.*, Vo.88, July 1983.
- Prabhudesai, R.G., Joseph, A., Agarvadekar, Y., Dabholkar, N., Mehra, P., A. Gouveia, A., Tengali, S., Vijaykumar, and Parab, A. (2006), Development and implementation of cellular-based real-time reporting and Internet accessible coastal sea level gauge- A vital tool for monitoring storm surge and tsunami. *Current Science*: 90(10); 1413-1418.
- Prabhudesai, R.G., Joseph, A., Mehra, P., Agarvadekar, Y., Tengali, S. and Vijaykumar (2008), Cellular-based and Internet-enabled real-time reporting of the tsunami at Goa and Kavaratti Island due to Mw 8.4 earthquake in Sumatra on 12 September 2007. *Current Science*: 94,10 May 2008; 1151-1157.
- Prabhudesai, R.G., Joseph, A., Agarvadekar, Y., Mehra, P., Vijaykumar, K. and Luis, R. (2010), Integrated Coastal Observation Network (ICON) for real-time monitoring of sea-level, sea-state, and surface-meteorological data. *Proc. Oceans'10 MTS/IEEE*; Seattle, Washington; USA; 20-23 September 2010, 9 pp.
- Titov, V., Rabinovich, A.B., Mofjeld, H.O., Thomson, R.E., and Gonzalez, F.I. (2005), The global reach of the 26 December 2004 Sumatra tsunami, *Science*, 2005, 309,2045-2048.
- Titov, V.V., Moore, C.W., Greenslade, D.J.M., Pattiaratchi, C., Badal, R., Synolakis, C.E. and Kanoglu, U. (2011), A New Tool for Inundation Modeling: Community Modeling Interface for Tsunamis (ComMIT), *Pure Appl. Geophys.* 168, 2121-2131.

Comparison Test of Radar Gauge and Float Gauge at JMA (Japan)

Hironori Hayashibara
Japan Meteorological Agency,
1-3-4 Otemachi, Chiyoda-ku, Tokyo 100-8122, Japan

*Contact person: H. Hayashibara
E-mail: tide@climar.kishou.go.jp*

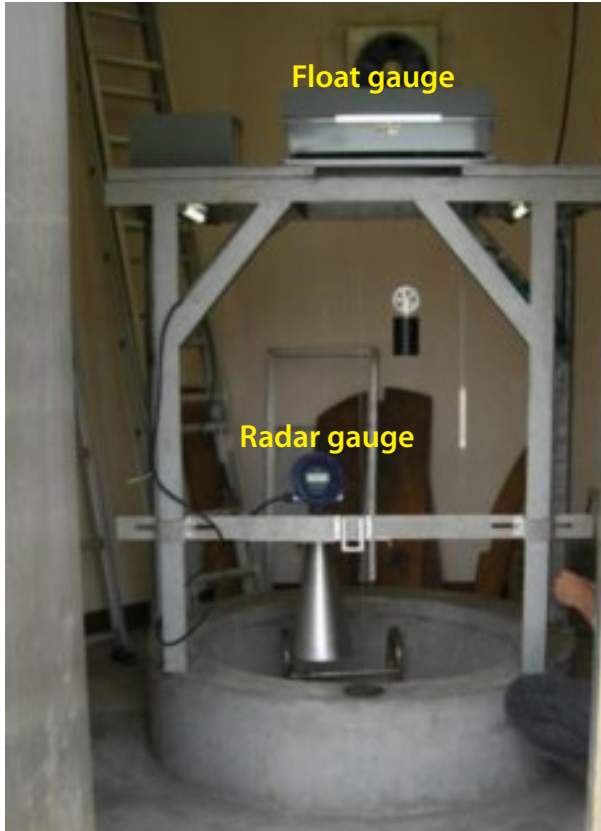

Figure 1. The radar gauge and the float gauge at Tokyo tidal station during comparison test.

Japan Meteorological Agency (JMA) performed a comparison test of tidal level observed by radar gauge and float gauge at Tokyo tidal station located at 35°39'N, 139°46'E from May 2008 to January 2010 in order to confirm whether the performance of a radar gauge can be comparable to traditional float gauge before adopting radar gauges for operational use.

MRG-10 manufactured by Tokyo Keiki and DFT-2 manufactured by Kyowa Shoko were used in this test as radar gauge and float gauge, respectively. The microwave frequency irradiated from MRG-10 is 5.8GHz and its opening angle of microwave is 17 degrees. It was installed near the rim of the well to avoid the influence of microwave reflected from the float at the center of water surface in the well. The picture installed these gauges is shown in **Figure 1**.

Figure 2 shows the time series of tidal level data observed by the radar gauge and the float gauge at Tokyo tidal station and the difference between the two tidal levels in December 2008. The differences were found approximately less than 5mm, and were small as compared to the JMA's criterion of +/-10mm for tidal observation sufficiently. The results during the other period were also similar to those in December 2008.

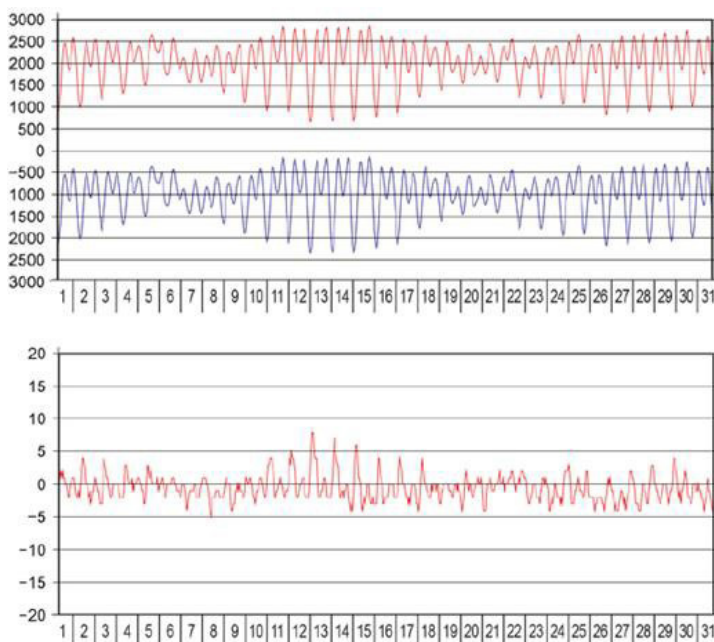

Figure 2. The result of comparison test at Tokyo tidal station in December 2008.

Top: The time series of tidal levels observed by the radar gauge (red curve) and the float gauge (blue curve). Latter is shifted -3000mm.

Bottom: The time series of difference obtained by subtracting tidal level of the float gauge from that of the radar gauge.

Therefore we concluded that the radar gauge had comparable performance to the float gauge. **Figure 2** also shows the differences over 5mm were found sometimes on 12-13 December, 2008. The time when the differences were over 5mm corresponded to the time at low tide during spring time. These phenomena were also found at low tide during other spring tides. It's because the radar gauge became to detect the microwave reflected from the surface of the float, which was nearer to sensor than water surface, under the condition the distance between radar gauge and water surface became farther.

When JMA installed the radar gauges, MRG-10 at 44 tidal stations with a well, measurement errors were found at some stations, due to the interior shape of the well and/or the presence of objects with the well such as a ladder. To reduce errors, we adjusted the direction of radio polarization suitable for the interior shape of the well, finely shifted the installed position of the radar gauge over the well and rewrote the firmware stored in the radar gauge to optimize the detecting time of reflected microwave.

*Experiences with Radar Gauges
by the South African Navy
Hydrographic Office*

Ruth Farre (BSc. Cert. Nat. Sci.)
South African Navy Hydrographic Office,
Private Bag X1, Tokai, 7966, South Africa

*Contact person: R. Farre
E-mail: hydrosan@iafrica.com*

○ Introduction

The South African Navy Hydrographic Office (SANHO) is the responsible authority for the installation and maintenance of the tide gauge network around the South African Coastline. The SANHO is also responsible for the acquisition, processing, archiving and dissemination of sea level data for South Africa and Namibia.

The SANHO was established in 1954, with installation of the first of its own float-type tide gauges following in 1957. Over the next 59 years various types of tide gauges were developed or purchased and put into use to ultimately gather the best quality data possible.

Towards the end of 2002 a Radar tide gauge was put on trial in Simon's Town along with an acoustic gauge, float actuated gauge and pressure sensor gauge. The results were compared and the results indicated that the Radar gauge performed with a higher degree of accuracy and stability than had been previously encountered. The Institute of Maritime Technology (IMT), after independent study, reaffirmed the results obtained by the SANHO trials. By 2007 all 10 of the South African tide stations as well as the two stations in Namibia were replaced with radar gauges, with four of these tide gauges being fitted with satellite transmitters (OTT HDR) which form part of the Indian Ocean Tsunami Warning system



Figure 1.
Stirrups
deployed
in Lüderitz,
Namibia.

○ Calibration

Since installation, with regular routine maintenance and firmware upgrades, the radar gauges perform consistently well producing good quality, accurate data that seldom requires a lot of post processing.

The radar gauges at all stations in the tide gauge network were initially calibrated every 6 months to establish their sensitivity to the environment, as well as stability and data integrity. Over the years this bi-annual calibration was replaced with an annual calibration, to maintain data integrity, as the radar gauges have shown little or no instrumental drift.

By leveling the transducer into the local benchmark network, the relationship between the gauge and Chart Datum is established and subsequently the relationship to Land Leveling /Ordinance Datum can be established. The SANHO uses the stirrup method to obtain the reference level/ tide gauge zero to be input into the data loggers on installation, as well as to calibrate the tide gauges (**Figure 1**).

○ Problems and Solutions

Power

Something that was regularly experienced over the years was that local or national power grid outages in the area of the tide gauge sometimes required the logger and 56k modem to be rebooted once the power was restored. It became very important to have a trustworthy local contact that could carry out this “reboot/ kick-start”, so as to re-establish communications with the gauge. These power outages often resulted in power surges when the power was restored. Over time these power surges lead to resultant damage within the Power Conversion Units (PCU12) and even to an electrical fire in two of the tide gauge electronics cabinets. It became evident that a stable power supply was required and investigations into alternative methods of supplying power to the tide gauges began. Surge protectors have also been installed at all the mains power points.

A solar panel power system (80W solar panel, 12V battery and regulator) has been on trial in Cape Town since November 2013 and has yielded excellent results. Over the following 3-4 years the entire South African tide gauge network will be installed with solar power systems, which should alleviate the problem of power failures, damaged power lines and power surges damaging equipment.



Figure 2. Durban's transducer showing corrosion damage.

Communication

The gauges were connected to 56k modems that allowed the Tidal Department to manually dial into the logger and download the stored data on a bi-weekly basis. With the rapid advances in technology, the telephone lines throughout South Africa were being changed over from the old analogue (copper) to digital (fiber optic) and VOIP (voice over internet protocol) lines. This created a problem with connecting to the tide gauges as the 56k analogue modems were not compatible with these new lines. In some areas, older lines that were either stolen for the copper or damaged were not being replaced by the national telecommunications carrier and this led to another problem.

Investigations on alternative methods of communicating with the loggers were undertaken. At the end of 2012,

beginning 2013 - the SANHO, with the co-operation of the Council for Scientific Industrial Research (CSIR), began upgrading the communication systems on the tide gauges from the now outdated 56k analogue modems to 3G/GPRS cellular communications. New loggers with built in 3G modems (OTT NetDL) have been installed in 8 of the 10 South African tide stations. The data now streams directly to a secure FTP site for our easy access.

South African Environment

Due to the extreme corrosive nature of the climate and environment around the South African coastline, all davits/structures have been built out of stainless steel and this has paid off with the longevity of these structures. Aluminum, even painted or bonded, does not last in the South African coastal environment, the tiniest chip in the coating leads to destructive corrosion within 6 months. This became evident when the satellite antennas in Durban and Simon's Town began to disintegrate. A small chip in the bonded coating of the OTT Kalesto Radar transducer in Durban led to the transducers "crumbling" and the housing to "explode" (**Figure 2**).

The SANHO is currently in the process of upgrading the older OTT Kalesto Radar to the OTT RLS radar transducers. These transducers are housed in heavy duty plastics, but due to the harshness of the sun in South Africa, even heavy duty plastic becomes brittle over time. In an attempt to combat this the OTT Kalesto and OTT RLS transducers have been coated in Denso Tape (synthetic fiber fabric tape impregnated with a neutral petroleum and inert siliceous fillers) to protect their housings and increase their waterproofing (**Figure 3**).



Figure 3. Transducers coated in Denso Tape.



○ Conclusion

Overall, the SANHO has found the radar type tide gauges to be reliable, easy to install and maintain. Due to the harshness of the environment and the large amount of biological fouling, sea level recorders that have limited contact with the water are preferable.

At present the quality of data being received from these gauges is far superior to the previously installed gauges. The quality of the data from the OTT RLS is of a better quality, due to the increased sample rates and accuracy, than the OTT Kalesto.

○ References

Denso SA (Pty) Ltd, Denso Tape Technical Data Sheet (<http://www.denso.co.za/burried/petrolatum.php>)

IOC Manuals and Guides No14 vol IV: an update to 2006 pages 67-68.

Use of a Stirrup to Calibrate a Radar Gauge (South Africa)

Ruth Farre (BSc. Cert. Nat. Sci.)
South African Navy Hydrographic Office (SANHO),
Private Bag X1, Tokai, 7966, South Africa

*Contact person: R. Farre
E-mail: hydrosan@iafrica.com*

○ Introduction

This note is based on information provided by Ruth Farre at an IOC training course on sea level measurements in Ostend in 2006, as well as on talks at the IHO Tides and Water Level Technical Training Workshops which were presented in South Africa and Abu Dhabi in 2015. It discusses the use of a 'stirrup' target to calibrate a radar gauge with an unknown Sensor Offset (SO). Other methods for determining the SO are discussed in Chapter 4 of the Manual. The SO itself is implicit, rather than explicit, in the below. However, we include this article to underline once again the probability of range measurements provided by a newly-purchased sensor being biased by having a non-zero SO, and that calibration of the sensor is essential.

In the next section, we go through the relationships between the various levels and the procedure for using the stirrup. In Section 3 we describe the stirrup itself. More details of using stirrups may be found in the Manual and in papers by Farre and by Pugh et al. in this Supplement.

○ Relationships between Levels

Imagine a stirrup target suspended beneath a radar gauge as shown below. The metal plate target is attached to the ends of rods of known length (G), and the rods and plate are suspended from a 5 mm thick supporting plate that rests on top of the sensor.

Also imagine that the gauge and its logger are set up to provide sea level (positive upwards). In this example, the gauge is required to report sea level relative to Chart Datum (CD) which is a distance B below Land Levelling datum (LLD).

We now have:

- A- Benchmark above LLD (from national levelling system)
- D- Benchmark to top of the stirrup support plate (from levelling)
- E- Length of the sensor from its top (where the support plate rests) to its face

Thus the sensor face above LLD is

$$A+D-E-0.005$$

And the sensor face above CD is

$$A+D-E-0.005+B$$

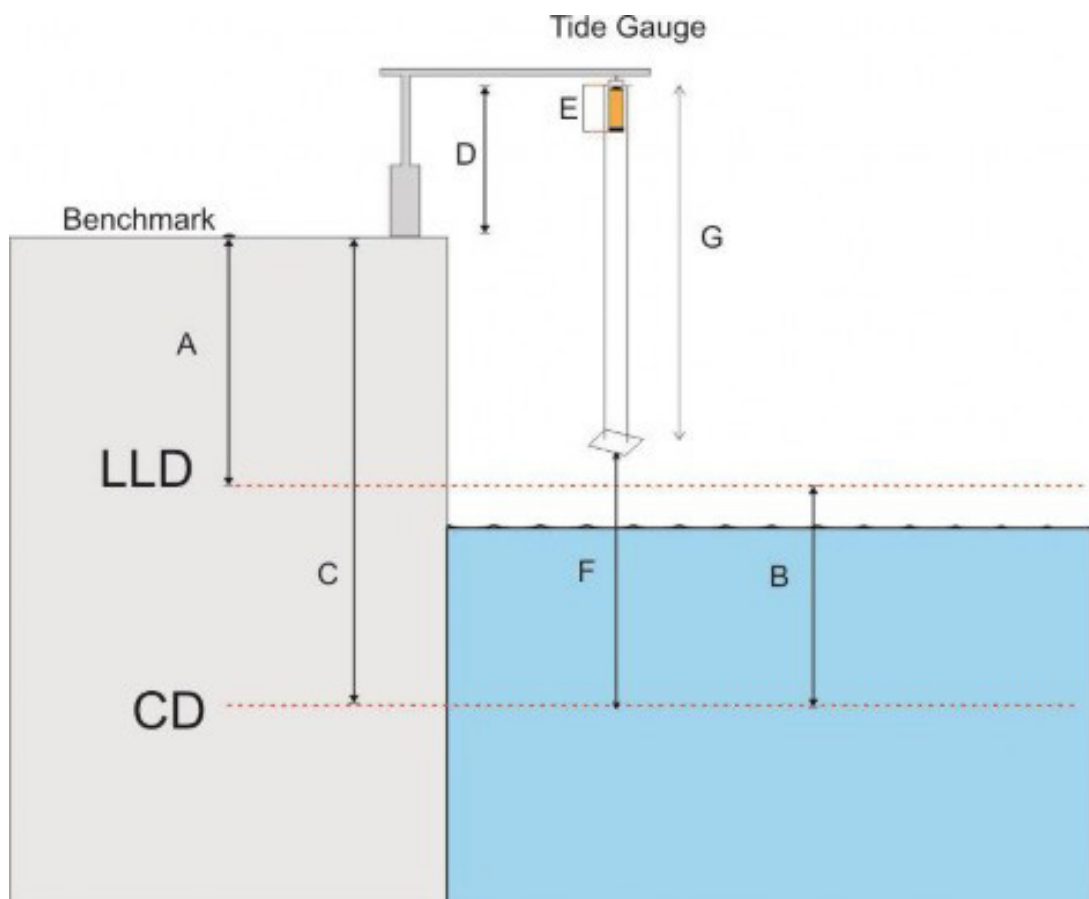

We can define this height above CD to be $Y = A + D - E - 0.005 + B$ and the tide gauge, if correctly calibrated, should now be reading $Y - (G - E)$.

The SAN HO recommends that recordings are made for at least 30 minutes. Determine the average of the readings and compare it with F. If the gauge is reading a value less than F, you need to add the difference between the average reading and F to set things up correctly. If the average is greater than F, subtract the difference. If they are the same, then the gauge is set up correctly.

However, the above procedure should now be repeated with different lengths of rods to simulate measurements at low and high tides. If the average tide gauge values now correspond with F in both cases, then no further adjustments need be made. It is important to note all this information and any changes in field notes that will be included in the station records.

○ Stirrup Details

The stirrups are made up of 1 m length rods that screw into one another to make up a long rod with an accurately known length. The total length required will depend on the maximum tidal range at a site. The rods can be made up of carbon fibre or thin stainless steel or aluminium tubing. It is better if a light material is used as you do not want a large weight balancing on top of the transducer, shifting its level position or damaging it. A stainless steel plate can be used as the target that is suspended below the sensor. This has to be as large as the expected full beam-width. Calibration should ideally be undertaken at times of spring low tides so as to enable the stirrup to be deployed over a large range of height.

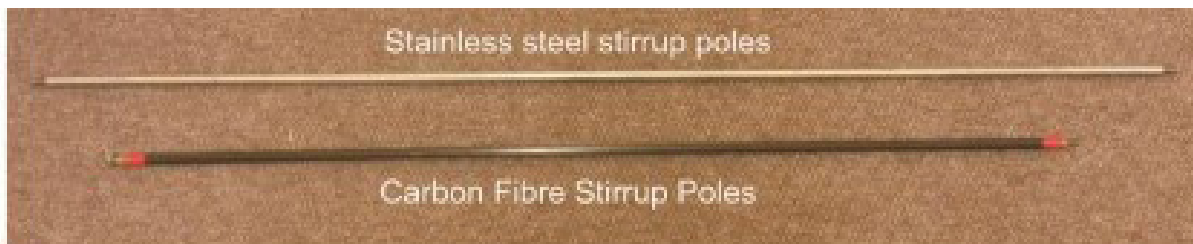

Stirrup Poles screw together to increase and decrease length



Target bolted to the calibrating rods

Experiences with Radar Gauges for Sea Level Measurement in Spain

Begoña Pérez¹, Diana López², José María Cortés², Bernat Puyol³

¹ Puertos del Estado, Avda. del Partenón, 10, 28042 Madrid, Spain

² SIDMAR Estudios y Servicios Oceanográficos, Benissa, Alicante, Spain

³ Instituto Geográfico Nacional, C/ General Ibáñez de Ibero, 3, Madrid, Spain

Contact person: B. Pérez

E-mail: bego@puertos.es

○ Introduction

Puertos del Estado (PdE) performed one of the first experiments in the world for testing radar sensors for sea level applications: the pilot station in Vilagarcía de Arousa harbor (NW Spain) in 2002; during this experiment, partly funded by the ESEAS-RI European project, up to 7 different technologies for sea level measurement were in simultaneous operation for more than one year. Details and main conclusions can be found in Martín-Míguez et al. (2005). According to this and other experiments (Woodworth and Smith, 2003, Blasi, 2008) radar gauges proved to be precise enough for sea level measurements according to GLOSS requirements.

Following Vilagarcía experiment, due to the tsunami event of May 2003 in the Balearic Islands, and the harbours need for simultaneous monitoring of higher frequency sea level oscillations and local wind-waves, PdE upgraded its REDMAR network from acoustic to Miros radar sensors, a process that was completed between 2006 and 2012. For this upgrade, old and new tide gauges were in simultaneous operation at 17 different harbours, with different meteorological, oceanographic and environmental conditions, for periods spanning approximately one year. A detail study of this simultaneous period, in order to guarantee the continuity and coherence of the historical time series, was performed for the whole network (Pérez-Gómez et al., 2014). Altimetry data in the vicinity of each station was included in the inter-comparison of the monthly mean sea levels. This allowed the detection and correction of instrumental problems, sometimes in the old acoustic sensors, others in the new radar sensors, and the generation of new revised historical time series for these harbours.

PdE has been operating Miros radar gauges for several years at very different installations and environmental conditions. The new technology has proved to be more precise and stable than the old acoustic (SRD) and pressure gauges (Aanderaa) in operation in the REDMAR network up to 2006-2008. Nevertheless, our experience has revealed the importance of maintenance and calibration protocols, independently of the type of technology employed. For this reason, we have investigated and designed new methods of calibration that will be described in section 2. As part of this experience an example of data inter-comparison between VegaPuls and Miros radar sensors, performed recently for the REDMAR station at Gijón, will be presented.

Other institutions in Spain such as the Spanish Oceanographic Institute (IEO) and the National Geographic Institute (IGN) started the upgrade of their old float gauges to radar gauges in recent years. While PdE selected the Frequency Modulated Continuous Wave (FMCW) radar sensors (Miros) for simultaneous measurement of wind waves, these other institutions have usually installed pulse radar sensors inside wells or tubes; both types of installations are today operating simultaneously at several harbours, what will allow performing long term comparisons between both types of radar based sea level stations in the near future. A first example of this inter-comparison at Almería harbor is described in this paper, with particular focus on the effect of wind waves in the measurements.

○ New protocol of calibration and maintenance for the REDMAR network

A hardware problem detected by PdE in several Miros antennas in 2010 (now solved), led to the decision, in agreement with the Miros maker, of defining new monitoring and calibration protocols for our radar gauges. First of all, PdE has adopted a rotation policy for the Miros sensors in order to allow their periodic verification at the laboratory or logistic park (today the SIDMAR company headquarters). This is performed during the routine annual in-situ maintenance in such a way that each antenna is tested at SIDMAR every two years. At the same time in-situ calibration is performed once per year, during the annual maintenance visit, by installing during several hours a VegaPuls62 radar gauge,

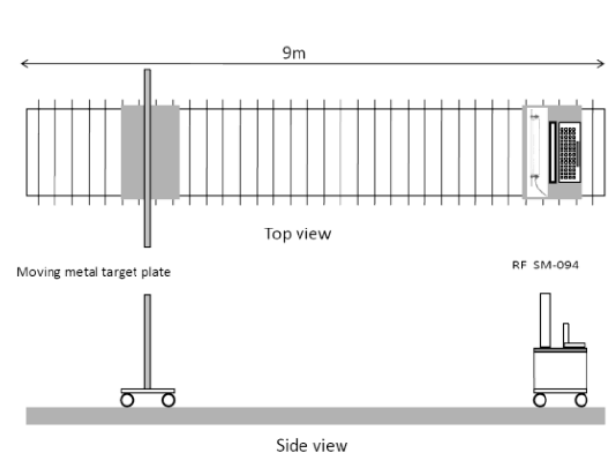

Figure 1. Testing structure for the verification and calibration procedure of the Miros sensor at the laboratory.



Figure 2. Test station established by SIDMAR technicians at Gijón REDMAR station. Two pulse radar sensors were installed beside the Miros, one measuring inside a stainless steel stilling well (the VegaPuls62, see detail on the right figure) and the other (a VegaPuls42) in the open air, nearby the Miros antenna (left).

previously calibrated in the lab, beside the permanent Miros sensor. Finally, configuration parameters of the antennas are now also remotely and automatically monitored by the maintenance technicians.

LAB verification and calibration of Miros water level sensors (offset determination)

For the laboratory “verification procedure” the Miros sensor is placed on a testing structure facing a metal target plate that, by means of a small rail train, can be moved and located at different distances from the antenna (**Figure 1**). Miros measurements are compared with a laser sensor of 1mm accuracy for different positions or distances to the target plate. The antenna is considered to pass this test if the mean differences are less than 1mm. If larger, the “calibration process” starts, by computing and fixing the offset value of the Miros and repeating again the “verification procedure” until the differences laser-Miros are lower than the laser accuracy.

In-situ calibration procedure of Miros water level sensors. Experiment at Gijón station.

The new Miros sensors of the REDMAR network are all mounted in open air to measure higher frequency phenomena including wind wave parameters, one of the secondary products required at some of the stations, and to reduce costs of maintenance and infrastructure. This has one disadvantage, however: the difficulty of making the usual manual tape measurements during a complete tidal cycle, as recommended by the Global

Sea Level Observing System (GLOSS: IOC, 1997, 2002 and 2006) when a tube or well is not available. This is particularly important at those stations most exposed to wind waves, even if these are small. It seemed reasonable therefore to think of using a secondary well calibrated sensor during the maintenance visits that would provide more accurate calibration than the manual measurements.

For this reason, following the instructions of Puertos del Estado, the maintenance company SIDMAR performed between the end of 2012 and 2014 several inter-comparison experiments of the Miros permanent sensor with other pulse radar sensors and pressure sensors, in order to select the adequate methodology and sensor configuration of the routine in-situ calibrations. The stations of Gijón (North of Spain) and Gandía (Mediterranean coast), with very different tidal regime and wind wave conditions, were selected for these tests. Although a very detailed analysis of all the data compiled is still to be finished, preliminary results were sufficient to decide the use of the most recent model of Vega radar, mounted in open air, for calibration of the permanent Miros stations.

At Gijón harbor, two additional pulse radar sensors (a VegaPuls42 and a VegaPuls62) were installed beside the Miros the 14th of November of 2013. The VegaPuls62 was mounted in a stainless steel stilling well (6.3 cm diameter) and the VegaPuls42 in open air on top of the Miros structure (**Figure 2**). Raw data from the two

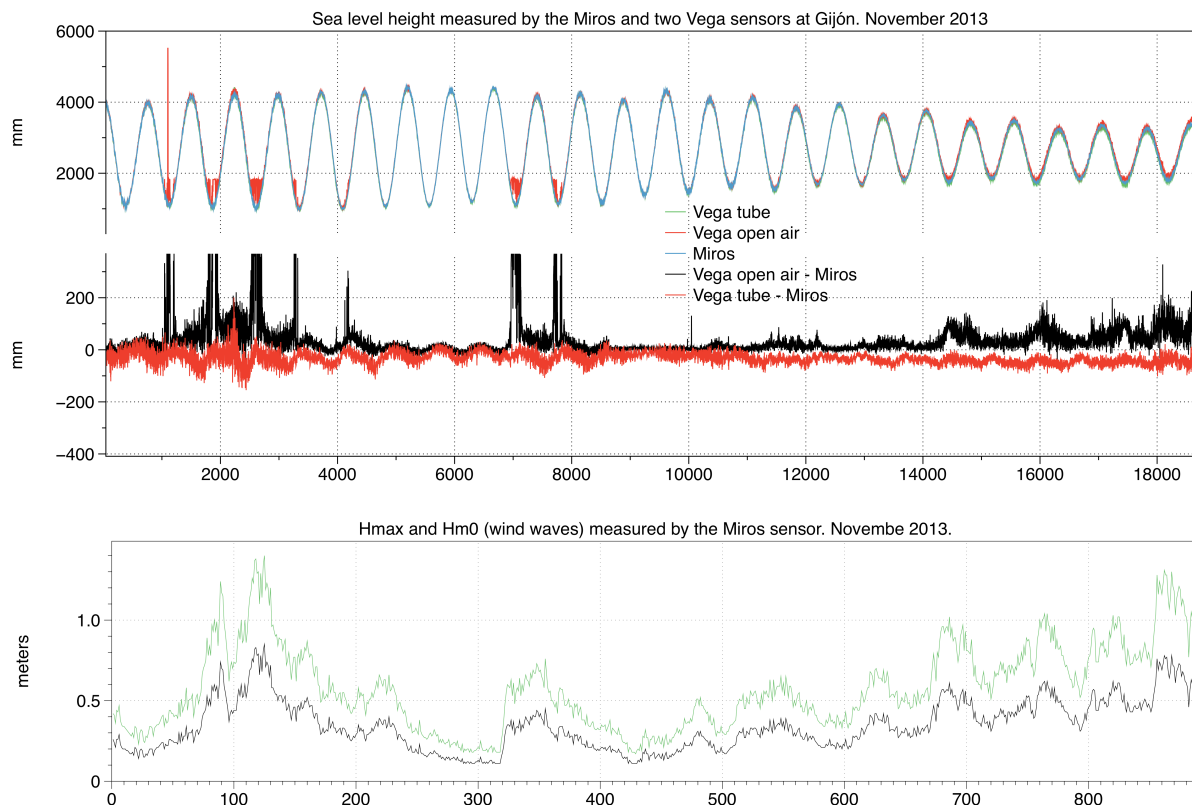

Figure 3. Top panel: 1-min sea level data measured by the three sensors (Miros, Vega inside a tube and Vega in the open air) at Gijón harbor, for 14-27 November 2013; medium panel: evolution of the differences between the two Vega sensors and the Miros sensor for the same period; bottom panel: Hmax (green) and Hm0 (black) recorded by the Miros sensor for the same period.

Vega sensors were taken with a sampling frequency of 1Hz, while the Miros provides 2Hz raw data; however, only 1-min averaged water levels are used for the intercomparison study for all the sensors, that were configured to provide sea level data with respect to the same datum (the REDMAR datum).

The Vega sensors employed in the experiment were at that time installed with the original configuration provided by the maker, including internal filtering algorithms that make their response to higher frequency oscillations slower than that of the Miros sensor, for example. However, as the main objective was not measuring wind waves but to determine the adequate datum and offset calibration of the Miros antenna, this was not considered critical at this stage. We show here the output of this intercomparison at Gijón for the period 14th to 27th of November 2013 (Figure 3). The 1-min sea level measurements provided by the three sensors (top panel) are plotted against the differences between each of the Vega sensors and the Miros (medium panel) and the wind wave parameters measured by the Miros during the same period (bottom panel: maximum wave height in green and significant wave height in black).

The first evident problem appears in the VegaPuls42 (red line for sea level time series, black line for differences time series), which presents wrong data when the waves are important and the distance of the sensor to the water is larger than a certain value (near low waters). This may be due to the fact that the VegaPuls42 range of measurements is only 10 m, very close probably to the maximum distance to the low waters during spring tides at Gijón. As we move towards neap tides this effect in fact disappears but other relevant issues become evident.

An interesting feature is the fact that the two Vega sensors differ more between themselves than from the Miros sensor. In general, we observe that when the wind wave height increases, sea levels inside the tube (VegaPuls62) are lower than sea levels outside; at the same time, the sea levels measured by the VegaPuls42 outside the tube are larger than the Miros sea levels when the wave activity is important. This is reflected in the opposite signs observed in the bias or mean of the differences (Figure 3, medium panel) during the last tidal cycles, with increasing wind wave activity (-4 cm and 4 cm respectively). The observed bias is still important (up to 2 cm) for the tube measurements when the wave heights are lower. The agreement between the two open

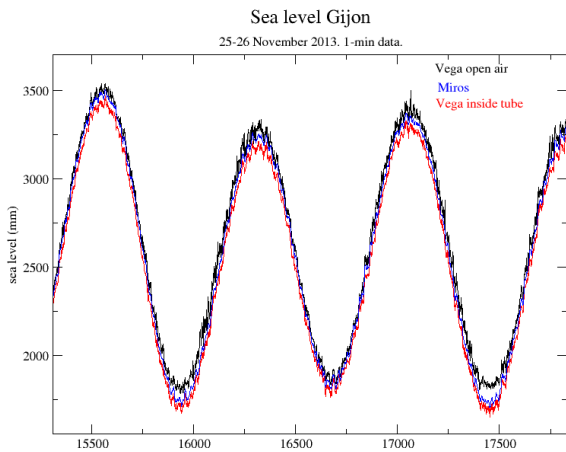

Figure 4. Zoom of 1-min sea level data for the two Vega radar sensors installed in Gijón in November 2013 and the permanent Miros sensor.

air mounted radar sensors is very good however during calm weather periods (bias practically null), as can be seen in **Table 1**. **Figure 4** shows a zoom of all these time series for the 25th of November.

Interestingly, the largest differences are therefore found between the two Vega sensors, outside and inside the tube, when the wind waves are important. If the sensors were perfectly calibrated to the REDMAR datum, this would mean that the stilling well adds a mean difference even in good weather conditions with respect to the open air sensors, of about 2 cm. For this reason, for the routine in-situ calibrations we decided not to use a tube by now. Other experiments revealed later that the new model of VegaPuls (the VegaPuls62) worked in fact better in open air than the previous model (VegaPuls42) employed in this experiment. Today the original filters of the Vega may be discarded for a faster response to high-frequency oscillations.

Based on this experience, a new routine annual in-situ calibration was finally established, that consists nowadays in installing a calibrated VegaPuls62 radar sensor in the same structure than the Miros during one

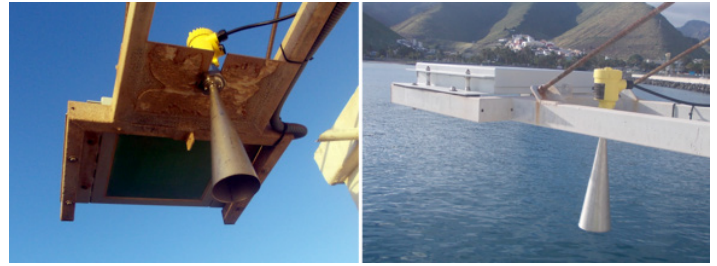

Figure 5. Installation of a VegaPuls62 radar beside the Miros permanent sensor for in-situ verification during routine annual maintenance visits.

day or a complete tidal cycle (**Figure 5**). The VegaPuls62 is leveled to the TGBM and calibrated to the station datum in order to use the same reference than the Miros sensor. A near-real time tool allows monitoring the differences of the 1-min averaged data of both sensors and their basic statistics (mean, standard deviation, root mean square error). This allows testing the correct performance concerning datum stability of the Miros on the field.

○ Long-term comparison of VegaPuls and Miros radar sensors at Almería harbor

Almería harbour is on the Southeast coast of Spain, in the Alboran Sea. Two tide gauge stations from the National Geographic Institute and Puertos del Estado are placed at different locations, under significantly different wind-wave conditions, about 630 meters apart (**Figure 6**). The VegaPuls measures inside a stilling well, beside the old float gauge operated by IGN, at the end of the fishers quay, on a more sheltered and in principle old and stable area; the Miros sensor was placed in 2006 at a more recent and wind wave exposed position, for measuring high frequency oscillations and wind waves. Both sensors complement each other perfectly and real physical differences are expected, especially for higher frequencies; on the other hand, this Miros sensor

Table 1. Mean differences (μ) of Miros-Vega42 (open air) and Miros-Vega62 (stilling well) during a calm weather day (first row) and a day with wind waves (second row). Hs: mean significant wave height as measured by the Miros sensor for each day.

Period	Miros-Vega 42 (open air)	Miros-Vega 62 (stilling well)	Hs
18/11/2013 (00:00h -23:59h)	$\mu = -0.002 \pm 0.004$ m	$\mu = 0.020 \pm 0.010$ m	0.12 ± 0.03 m
25/11/2013 (00:00h -23:59h)	$\mu = -0.042 \pm 0.029$ m	$\mu = 0.048 \pm 0.014$ m	0.45 ± 0.07 m



Figure 6. Position of the two radar sensors in Almería: VegaPuls (pulse radar) from IGN and Miros FMCWF radar from PdE (REDMAR).

is probably the most exposed to wind waves of the REDMAR network, yielding a good test of their influence on the long term sea level measurements.

We present here the results of the comparison for monthly, daily, 15-min and 1-min averaged sea levels, for the years 2012 and 2013; as we reduce the averaging period larger differences become evident, partly caused by real spatial sea level variations that may hide the effect of instrumental errors.

Miros data are expected to be noisier and more affected by wind-waves but, up to which extent? On the other hand, in addition to the most sheltered position, the VegaPuls sensor is also known to damp high-frequency oscillations more than other radar sensors.

Although both stations have been measuring simultaneously since 2006, the final conclusions about the long-term comparison are not finished due to detection of potential datum problems that are being analyzed in detail. One of the problems could be the effect of delamination in the Miros antenna, although the differences observed in mean sea levels are not

coherent with this kind of error: a significantly larger trend is observed in the monthly means as measured by the IGN since 2006, while in principle, delamination caused a positive bias in sea levels in the Miros. Therefore we present only the results for years 2012-2013, when the main differences due to mentioned problems seem to have been solved and after replacement of the Miros antenna, in order to avoid unknown effects of delamination. The two years were used for monthly and daily means comparison, while 2012 is used for higher frequency data (15-min and 1-min).

The mean sea level anomalies at each tide gauge were computed before the intercomparison and computation of differences in order to ignore the datum difference between the stations. Standard deviations of these differences (**Table 2**) reveal good statistical performance (around 1cm or less) even for 1-min data, although for this sampling real spatial differences are expected due to the distance between the two tide gauges. **Figure 7** displays the histograms of these differences (distribution function of the error) for 1-min, 15-min and daily means.

Table 2. Main statistical parameters of the differences, for several data samplings, between IGN and REDMAR tide gauges at Almería harbour.

	Stdv (mm)	Bias (mm)	Rmax (mm)	Rmin (mm)	Corr	Slope
Monthly means: 2012-2013	0.43	-11.4	0.70	-21.3		
Daily means: 2012-2013	7.2	-11.3	13.3	-29.7	0.997	0.987
15' data: 2012	10.50	0.00	58.0	-103.0	1.000	0.997
1' data: 2012	10.60	-9.00	107.10	-150.4	0.998	1.000

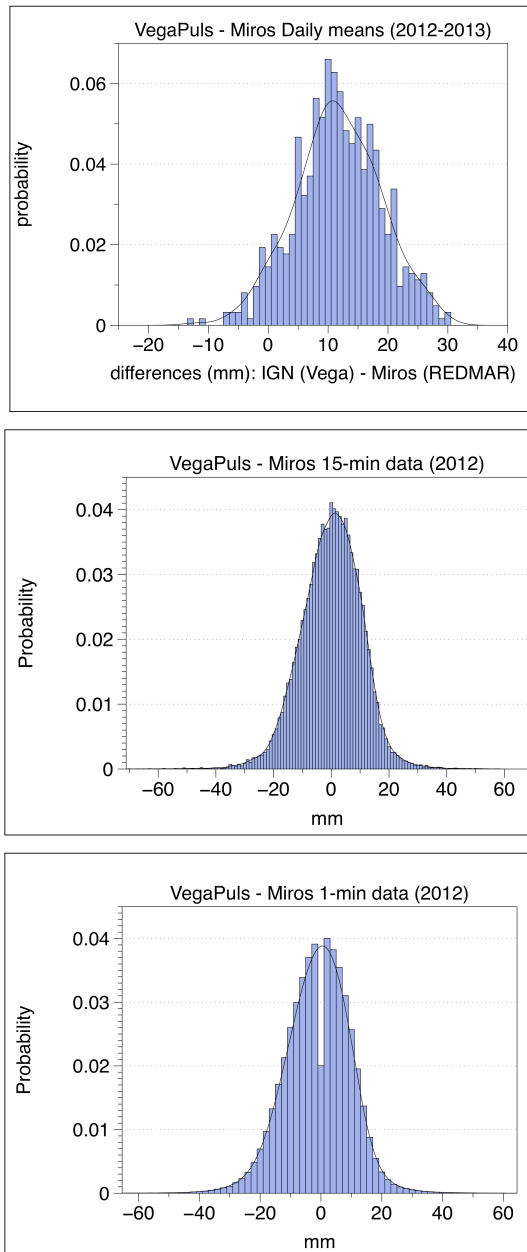

Figure 7. Histograms of the differences VegaPuls – Miros for different data sampling: 1-min, 15-min and daily mean sea levels.

There is a mean difference or bias of around 1.1 cm between both tide gauges if we consider the comparison of daily means for 2012 and 2013 and their differences in **Figures 7** and **8**: it seems that this bias is not constant but it has been increasing along the two years, at a statistically significant rate of 0.005 mm/day, enough for a change in mean sea level of 3.6 mm in two years. One possible explanation could be an incorrect datum definition in the Miros sensor after the gap in this time series, caused by an accident, at the beginning of 2013; this is currently being investigated. It is important to say that being the Miros in a more recent quay, one could expect initial “down” vertical movements at this station: however, the observed trend would reveal an “up” land movement of the Miros station with respect to the Vega one.

As already mentioned, one of the main interests of this intercomparison was to determine the impact of wind waves on the sea level measurements. It seems the effect is not evident in mean sea levels although it should be present in 1-min data, especially for two stations at different quays. Spatial differences caused by oscillations of periods of a few minutes will also affect the comparison of the two tide gauges for this sampling. Fortunately, we can try to relate these differences to wind wave data as provided by the Miros sensor (**Figures 9-12**).

Figure 9 shows how sea level differences become occasionally larger in the 1-min time series. In the same figure we have plotted the maximum and significant wave height measured by the Miros sensor for the same period (year 2012), reaching values of more than 3 m and 1-1.5 m respectively during the most extreme events. Although there is usually important wave activity for those periods with larger 1-min differences, this relation is not so straightforward as there are occasions when the

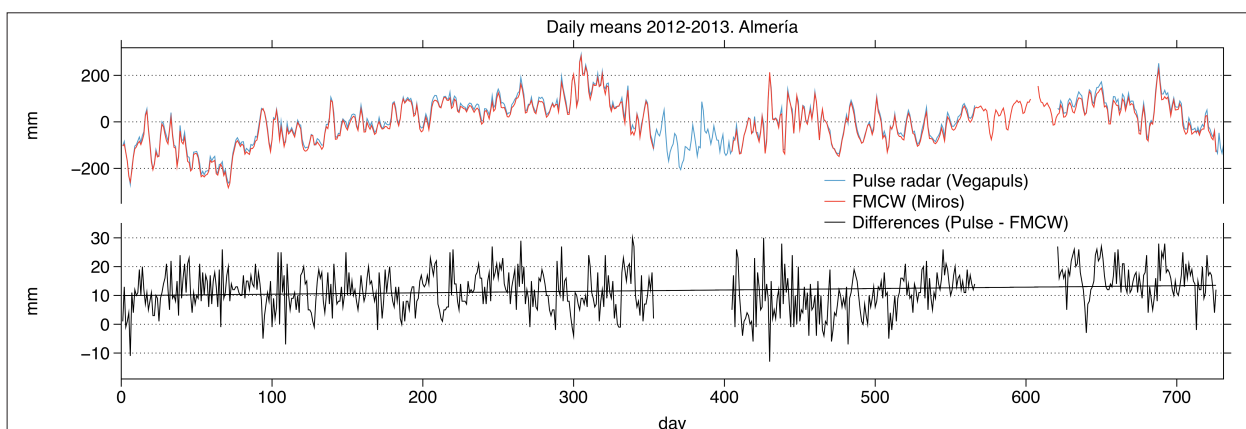

Figure 8. Comparison of daily mean sea levels from the Miros (REDMAR) and Vega (IGN) radar sensors in Almería, for the years 2012 and 2013.

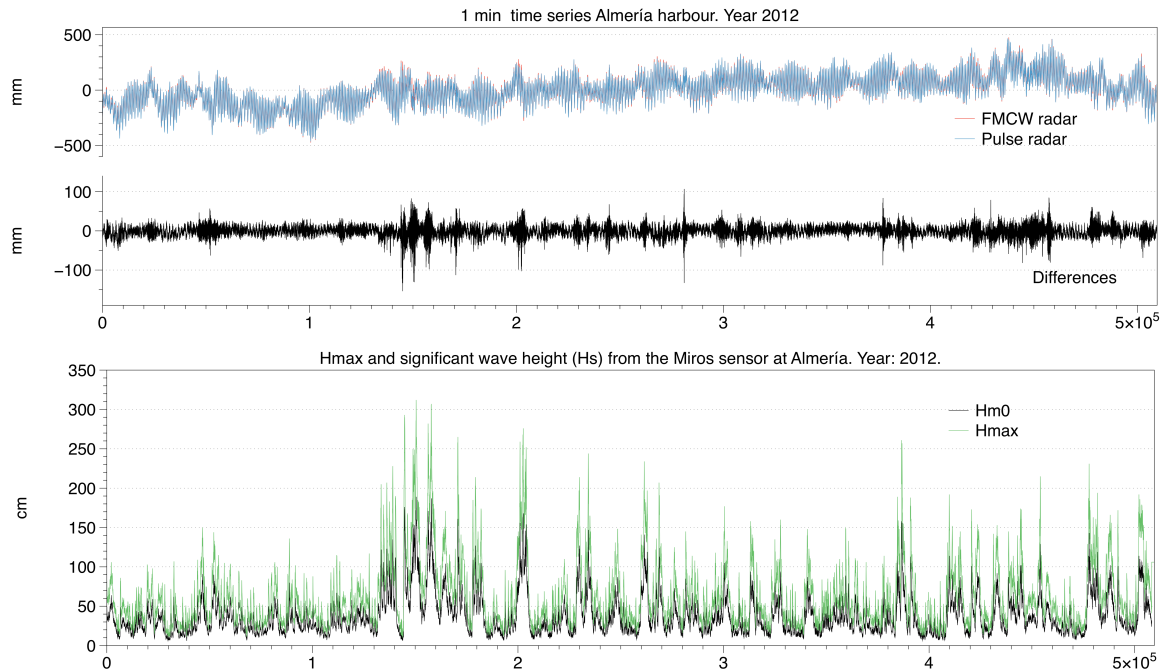

Figure 9. Top: 1-min data from both tide gauges and their differences for year 2012; bottom: simultaneous wind wave parameters (Hmax and Hs) as measured by the Miros sensor for this year.

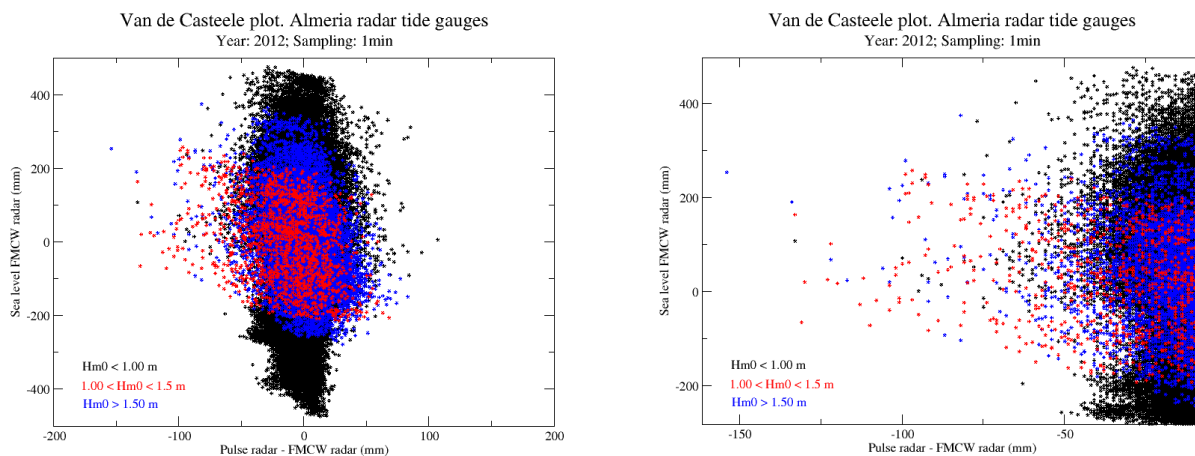

Figure 10. Influence of wind waves (as measured by the MIROS sensor) on the Van de Castelee plot: not clear correlation of high waves and larger sea level differences, although the FMCW radar does measure higher sea levels sometimes in the presence of high waves.

wind waves are important and the differences in 1-min averaged sea levels remain small.

This is most evident in **Figure 10**, where the Van de Castelee test is displayed in different colours depending on the magnitude of the waves: black for those data when the H_s is lower than 1 m, red for those with H_s between 1 and 1.5 m and blue for the most extreme cases, with H_s over 1.5 m. Large sea level differences are not directly caused by wind wave amplitude according to these plots. There are specific situations when the Miros does measure significantly larger sea levels than the Vega, but this may happen independently of the amplitude of the waves. There are two main possible explanations:

a) that the effects of wave period and/or direction (that should be further explored including offshore data) are more relevant than the amplitude or/and b) differences in several minutes period oscillations that are differently measured at the two locations.

These comparisons for the particular case reflect once again that the effect of wind waves is not well understood yet and requires therefore more detailed studies in the line of the ones showed here: instrumental problems may be hidden by real spatial differences. At the same time there is an inherent difficulty on defining where "mean sea level" really is when dealing with 1-min or higher frequency samplings.

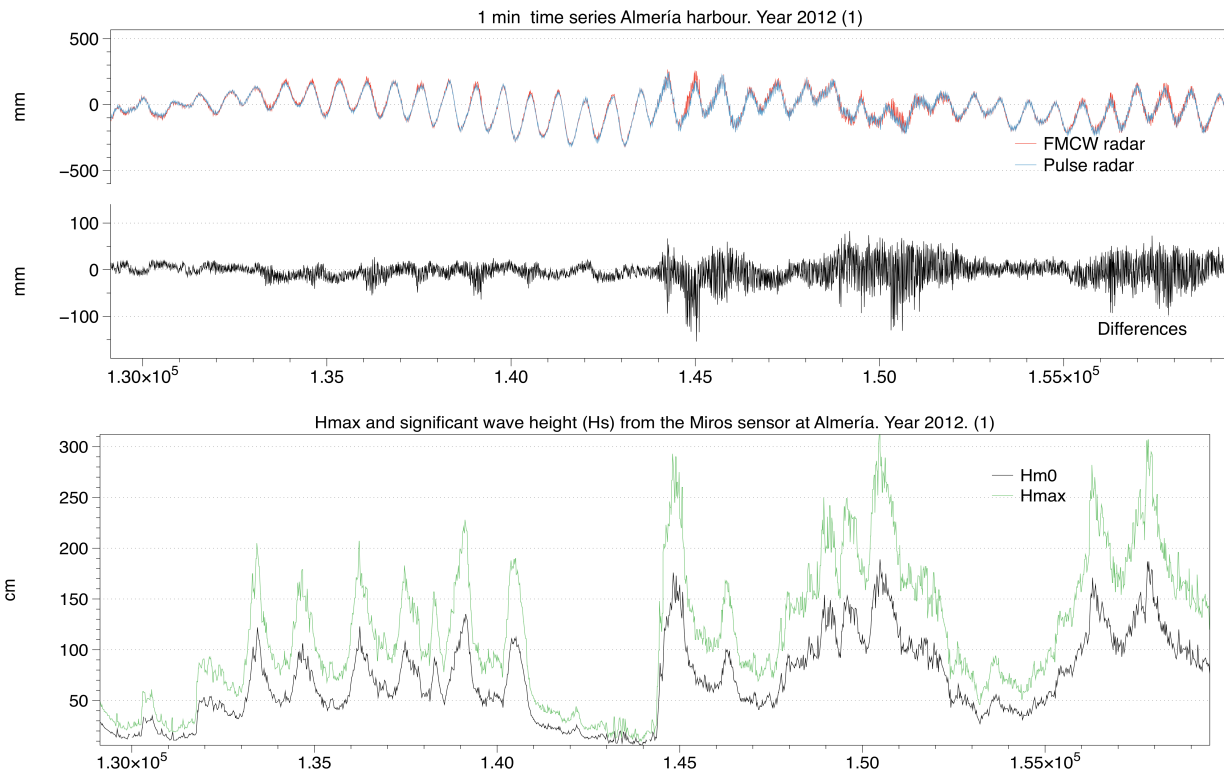

Figure 11. Zoom of differences of the 1-min time series (top) and wind wave parameters (bottom) at Almería harbour.

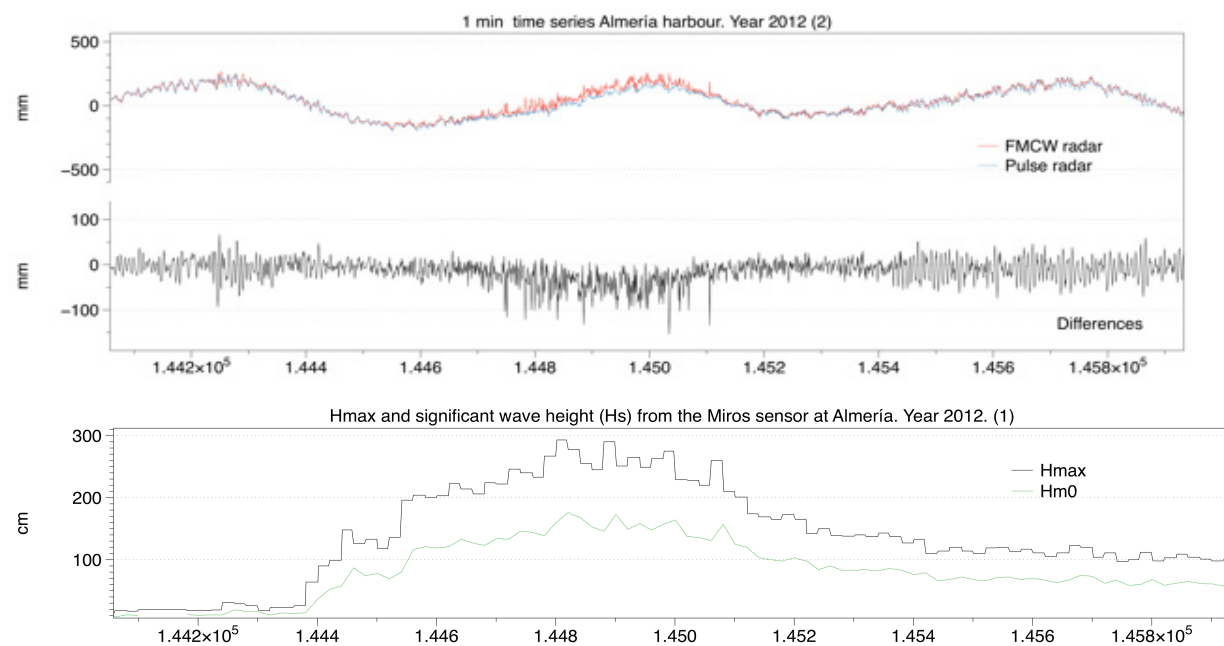

Figure 12. Zoom of differences of the 1-min time series (top) and wind wave parameters (bottom) at Almería harbour.

Figures 11 and 12 (zooms of Figure 10) show in detail, however, a situation when the increase in the differences seems to be related to an increase of wind wave height: differences of up to 10 cm may be reached, with higher 1-min sea level data in the Miros with respect to the Vega sensor. These differences reveal again, as mentioned

earlier, lower sea levels inside the well, although the origin in this case could be completely different. For example, one could expect wave setup, with strong spatial variation, to be more important at the Miros location than in the sheltered position of the Vega sensor.

○ Conclusions

After several years of operation of radar gauges in Spain, new protocols of calibration and maintenance have been implemented in PdE in order to guarantee the adequate performance of this type of sea level stations that, although with many important advantages with respect to other technologies, do still require careful understanding and monitoring. Influence of wind-waves on the sea level measurements remains to be carefully studied in the REDMAR network and it is an open question for the sea level community; from our experience, and taking into account that only a small set of the REDMAR stations reach from time to time up to 1-2 m of significant wave height, this wave activity is not enough to significantly alter hourly sea levels, tides and monthly means but may affect definition of what we consider an extreme sea level. Interestingly, wind waves do not always generate significantly larger sea levels in the Miros sensors; however, when they do, it is important to identify and distinguish spikes caused by the noise and waves effect, instrumental bias and what could be real wave set-up at the station. For this reason, we plan to perform more studies of their influence on the high-frequency sampling data (extremes) during these particular events.

Past experiences with Vega radar sensors confirm they are more affected by wind waves than the Miros sensors. However, new models provided by the maker have improved in this sense (due mainly to the possibility of avoiding internal filters). Today these new models are used for in-situ datum calibration in the REDMAR network, with more confidence than manual measurements without a tube or stilling well.

IGN has also several radar gauges in operation nowadays, as many other institutions in Europe. Due to their main interest in geodesy and mean sea level studies, they use pulse radar sensors usually located inside their old stilling wells. In most of the cases they also maintain the old float gauges in operation.

PdE and IGN are nowadays collaborating on the intercomparison of their different radar gauges at those harbours where both institutions operate a station: Almería, Coruña and Tenerife harbours. Almería REDMAR tide gauge is possibly one of the REDMAR stations most focused on wind-waves monitoring so wind-waves effect is expected to be more important here; comparison with the IGN pulse radar sensor and float gauge in a stilling well can be an interesting exercise for quantifying this effect in the MIROS sensor.

○ References:

- Blasi, C.J. 2008. A new technology for the measurement of the sea level and the sea state. *Environmental Geology*, 57, 331-336.
- IOC 1997. Global Sea Level Observing System (GLOSS). Implementation Plan – 1997. IOC Technical Series No. 50, UNESCO.
- IOC 2002. Manual on Sea-Level Measurements and Interpretation. Volume 3: Reappraisals and Recommendations as of the Year 2000. Intergovernmental Oceanographic Commission Manuals and Guides, No. 14. Paris: IOC.
- IOC 2005. Global Sea Level Observing System (GLOSS): The Group of Experts on the Global Sea Level Observing System (GLOSS). IOC/GE-GLOSS-IX/3. Ninth Session. Paris, France 24-25 February 2005. Available from: <http://unesdoc.unesco.org/images/0014/001400/140083e.pdf>
- IOC 2006. Manual on Sea-Level Measurement and Interpretation. Volume 4: An Update to 2006. Intergovernmental Oceanographic Commission Manuals and Guides, No. 14. Paris: IOC.
- Martín Míguez, B., Pérez Gómez, B. and Álvarez Fanjul, E. 2005. The ESEAS-RI sea level test station: Reliability and accuracy of different tide gauges. *International Hydrographic Review*, 6, 1. 2011.
- Pérez-Gómez, B., Payo, A., López, D., Woodworth, P. L. and Alvarez Fanjul, E. Overlapping sea level time series measured using different technologies: an example from the REDMAR Spanish network. *Natural Hazards and Earth System Science*, vol. 14(3), pages 589-610, 2014.
- Woodworth, P.L. and Smith, D.E. A one-year comparison of radar and bubbler tide gauges at Liverpool. *International Hydrographic Review*, 4, 2-9.

Channel Coastal Observatory Experiences with Radar Gauges (U.K.)

Travis Mason¹, Robin Newman²

¹ Channel Coastal Observatory, National Oceanography Centre,
European Way, Southampton, SO14 3ZH, United Kingdom

² Fugro EMU Limited, Victory House, Trafalgar Wharf, Hamilton
Road, Portsmouth, PO6 4PX, United Kingdom

Contact person: T. Mason

E-mail: travis.mason@noc.soton.ac.uk

○ Introduction

The Channel Coastal Observatory has used radar tide gauges at 5 coastal sites around southern UK, since 2006. The deployment lengths vary from 9 years (Deal Pier) to 3 years (Severn Bridge). The gauges are deployed by the National Network of Regional Coastal Monitoring Programmes of England; they do not form part of the UK's operational flood warning system and have neither a secondary measurement system nor a secondary data transmission route. Nevertheless, we aim to provide measurements of a similar quality and recovery rate to the UK's primary tide gauge network, in order to provide data suitable for all purposes. The sites are all nested inside the UK's strategic network, either to fill gaps, where surge forecasting has been shown to be difficult, or where there are coastal engineering needs for additional tide data.

The instrument chosen in 2006 was the Saab (now Rosemount) WaveRadar REX, primarily due to its proven robustness following use on North Sea rigs; also, there were considerably fewer options at the time, which was around the start of interest in the UK in using radars for coastal tide gauges. Cost was an important consideration, with the higher instrument cost by far outweighed by the lower maintenance costs over the long-term deployment period. After several years' experience, 6-monthly service visits were reduced to (and remain at) 9 months.

The main siting consideration, particularly in macro-tidal, open coast areas, is achieving sufficient height above the sea surface (**Figure 1**) since if the instrument range to the sea surface is insufficient and the returned energy decay curve is still reducing in an exponential phase, the radar cannot robustly resolve the surface. Furthermore, on an operational note, although the instrument can withstand spray, full immersion in sea water will trip the mains electricity, which subsequently requires manual re-setting. The spring tidal range measured at our sites varies from ~2m (with double high water) at Swanage to ~14m measured at the site of the Second Severn Crossing. This instrument is sited some 30m above the mean sea level, so the blanking distance of the instrument was increased to maximum, which had the bonus of reducing potential noise from reflections from the steelwork.

○ Installation and operation

Installation can be complex. All our sites have mains power, we have no experience with DC versions of the REX. Purpose-built frames are installed to allow the

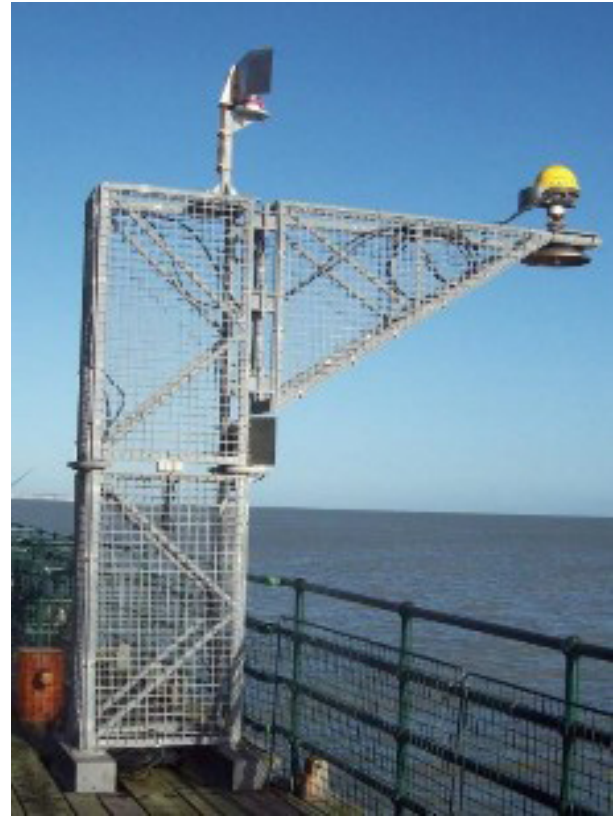

Figure 1. WaveRadar REX on Deal Pier © Canterbury City Council

instrument to be swung inboard for maintenance and returned to exactly the same position (**Figure 2**). The installation on the Severn Bridge involved a 2km cable run. Once installed, however, routine maintenance is straightforward.

The Tide Gauge Zero is established by 8-hour GPS observations using a purpose-built antenna clamp, tied in to the REX's measuring point via technical drawings (**Figure 3**). This method gives a vertical accuracy of $\pm 3.5\text{mm} + 0.4\text{ppm}$. The instruments are surveyed to Ordnance Datum, and transferred to Chart Datum using Admiralty Tide Tables, Supplementary Table III.

The instruments are programmed to log at 4Hz, subsequently averaged for 2 minutes every 10 minutes. In addition, a down-sampled 1Hz signal is forwarded to CCO's website, averaged to 5s and forwarded to IOC Sea Level Station Monitoring Facility.

The capability to measure non-directional waves concurrently has been a bonus. Waves are derived spectrally from a 30 minute burst at 4Hz, every 30 minutes. Three of the 5 sites are subject to wave action and considerable de-spiking etc. is needed in the processing software. Data spikes are a significant issue when processing downward-looking radar data,



Figure 2. WaveRadar REX on Swanage Pier © New Forest District Council.



Figure 3. GPS survey of WaveRadar REX on Teignmouth Pier ©Teignbridge District Council.

because the radars were originally conceived as range measurement devices to measure the liquid level in tanks, and therefore a simple time average is sufficient to remove the instrument noise. An average over 480 records produces a robust value for tide measurements, but for wave processing care must be taken to remove the outliers without reducing the observed wave energy.

○ Performance

We have not done any double-instrument testing, having neither the funds nor remit to do so, so our estimate of the accuracy and reliability of the REX is based on a range of observations:

Establishment of chart datum. After 13 months of measurements at a new site, the data are sent to the

UKHO, who conduct harmonic analysis and compare the results with their tidal models and their estimation of the local value of Chart Datum; no issues have been found to date.

Instrument drift. All service visits include gross error checks against direct measurements to the sea surface. Following the quality control checks recommended by the European Sea Level Service (Rickards and Kilonsky 1997), no instrument drift has been observed in the 10 minute time series over the longest deployment period. Annual values of Z_0 show some variation ($\pm 0.04\text{m}$), but no systematic trend.

Data spikes and wave bias. In most cases, our instruments are sited on open coasts and in moderate wave conditions spikes in the tide record are observed. For example, at Deal Pier on 28 December 2014, ~30

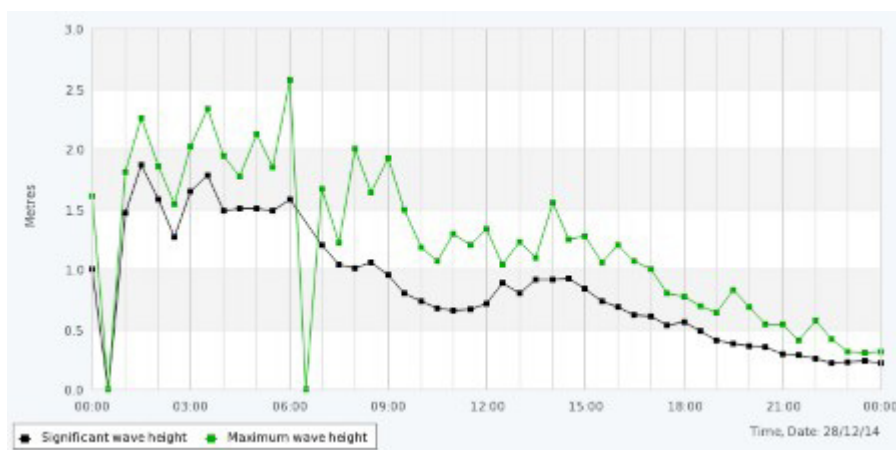

Significant wave height measurements from REX at Deal Pier, 28 Dec 2014



Tidal elevations from REX at Deal Pier, 28 Dec 2014

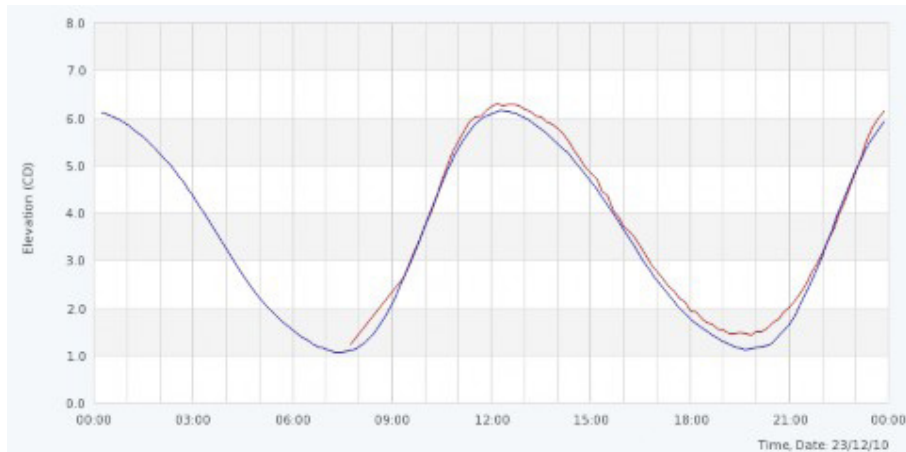

Tidal elevations from REX at Deal Pier, 23 Dec 2010



Tidal elevations from REX at Swanage Pier, 23 Jul 2015

kt north-easterly (onshore) winds and 1.5m Hs waves produced severe, intermittent spikes in the tide record. Note that the graphs above are real-time data, and that the spikes were later flagged during quality-control procedures.

Further observation at other sites along the English Channel have demonstrated that once winds reach near Gale Force, the tide record ceases to be as smooth as is usually observed from the 10 minute parameters. However, the effect depends chiefly on wind (wave)

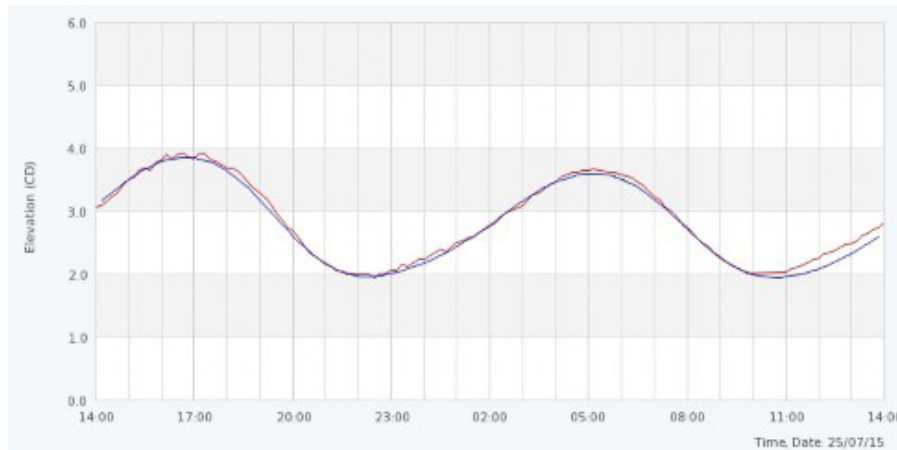

Tidal elevations from REX at Sandown Pier, 25 Jul 2015



Tidal elevations from REX at Teignmouth Pier, 27 Jan 2014

direction. For example, the largest waves measured at this site (23 December 2010) produced only minor and random fluctuations in the tide record, despite the 30 kt winds, but from the (relatively sheltered) north-west.

Note that the tidal range is also an important consideration, since minor fluctuations which are undetectable by eye over a 10m tidal range, can appear as an apparently unstable tidal curve at a micro-tidal site such as Swanage (note that tidal predictions at this site are notoriously difficult).

Other than the large spikes (which always tend towards 0m), there appears to be no systematic bias due to waves in producing either higher or lower water levels, with the minor fluctuations randomly distributed around the predicted tide level as shown in examples above at Sandown Pier or during the winter storms in 2014 at Teignmouth Pier.

○ Conclusions

The WaveRadar REX has proven to be robust and reliable, with relatively low maintenance costs during the cumulative 35 years they have been in service with us. The chief proportion of their total cost is in instrument purchase and installation, but running and unscheduled maintenance costs are relatively low – which is the better balance for a coastal monitoring programme like ours which receives fixed funding in 5-year tranches. Their role is to provide tidal data for coastal management, and the additional non-directional wave data is a particular benefit.

○ Reference

Rickards, L. and Kilonsky, B. (1997). WOCE “Delayed-mode” Sea Level Data Assembly Centre (DAC). www.bodc.ac.uk/projects/wocedac/guides/odpaper.html, 12 pp.

Experiences with Radar Gauges at NOC (U.K.)

Jeff Pugh, Peter Foden, Dave Jones,
Philip Woodworth and Angela Hibbert
National Oceanography Centre, Joseph Proudman Building,
6 Brownlow Street, Liverpool L3 5DA, United Kingdom

*Contact person: P.L. Woodworth
E-mail: plw@noc.ac.uk*

○ Introduction

For some years, NOC has used radar gauges (mostly OTT Kalesto and VEGAPULS-61) at South Atlantic islands, Gibraltar and several UK sites. In addition, it has worked with IOC and others to install radar gauges in Africa and the Indian Ocean. The radar gauges have been shown to perform well in general. In particular, they have demonstrated little or no instrumental drift over a long period (e.g. Woodworth and Smith, 2003). Consequently, we have decided that radars will be used as the main tide gauge at most remote sites in future as they offer many advantages for installation and maintenance.

In 2012, we began a programme to replace older radars with newer systems, with greater emphasis than before on two aspects. The first aspect concerns the calibration of the radar gauges so that they might provide reliable long-term mean sea level (MSL) data. Up until now, our pressure-based gauges have provided such data. However, we now needed reliable methods to determine the datum of the radar range measurements, in effect the Tide Gauge Zero. A second aspect concerns obtaining greater insight into how the radar gauges perform in the presence of waves.

We experimented with three pulse radars: Waterlog H-3611, OTT RLS and VEGAPULS-61. The former had been investigated extensively by NOAA (Heitsenrether et al., 2011), while the two latter systems were replacements from the same manufacturers for gauges we had already been using.

All the radars were operated in their default modes. The H-3611 can be used in either the default Normal (or Standard) or Fast modes to provide single measurements. Fast mode is faster as it does not perform the higher level of internal filtering that Normal mode applies. However, it is too fast for some data loggers so we decided not to use it for the moment. (These two modes give the same sea level spectra if 1 Hz data from each mode is low-pass filtered with a 20 second filter or longer, see Boon, 2014). The H-3611 also has a third mode, called NOAA mode, which involves 181 measurements one second apart every 6 minutes, giving 10 averages and standard deviations each hour as for NOAA's acoustic gauges. Normal mode has been found to have an approximately 60-second damping time (R. Heitsenrether, private communication).

We also operated the OTT RLS as supplied. This appears to result in a single measurement being averaged



Figure 1 [a]. The test frame at Holyhead holding (left to right) an OTT Kalesto that was not part of the test, an OTT RLS, a Waterlog H-3611 and a VEGAPULS-61. In this photograph the gauges are measuring the sea surface.

over approximately 30 seconds (or at least it takes 30 seconds for the measurement). The default mode for the VEGAPULS-61 also has an approximately 60-second low-pass filter applied to the measurements (Mai and Zimmermann, 2000; Heitsenrether and Davis, 2011). These different devices can be seen to sample sea level in different ways, which may contribute to how their data are affected differently by waves.

○ Calibration of Radar Gauges

This section describes methods we have investigated to determine the effective zero of the radar range measurements. Such calibrations can be expected to be performed both in the laboratory prior to installation, and subsequently on repeat visits to the station.

Field Experiments at Holyhead

In the first set of tests, the three gauges were installed at the Holyhead station in North Wales, where the mean tidal range is over 3.6 m, considerably larger than at any of our South Atlantic sites. The gauges were located at approximately 4 m above MSL. Holyhead is a station in the UK National Network with a bubbler pressure gauge as the primary sensor that we used to compare to the radars. They recorded sea level for about 1.5 months (**Figure 1 [a]**) after which there was a short test consisting of approximately 2 hours of measurements when a specially-made metal target was installed beneath them (**Figure 1 [b, c]**). Our South African colleagues call such a target a 'stirrup'. The design of the supporting frame

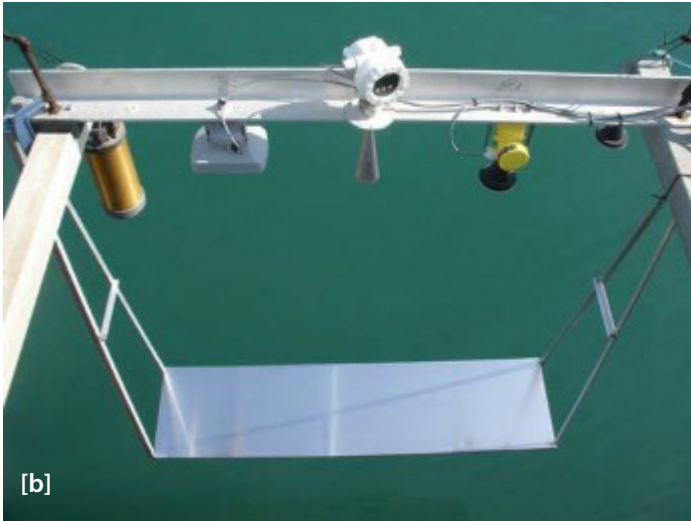

Figures 1 [b], [c]. The same frame and gauges with a metal target (stirrup) suspended beneath them.

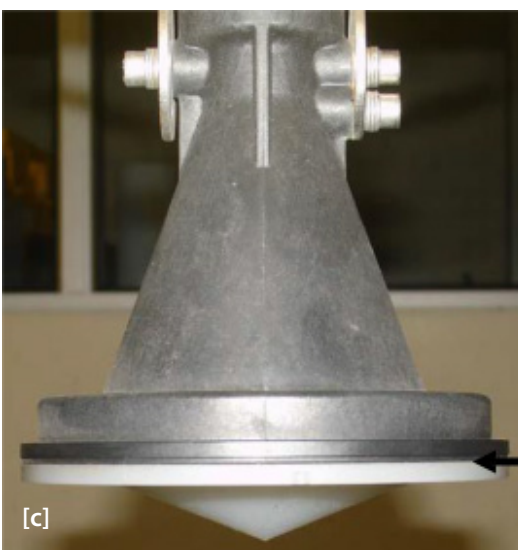
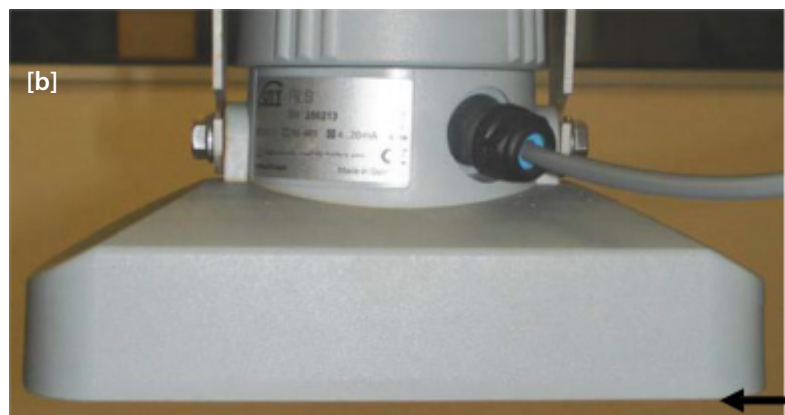
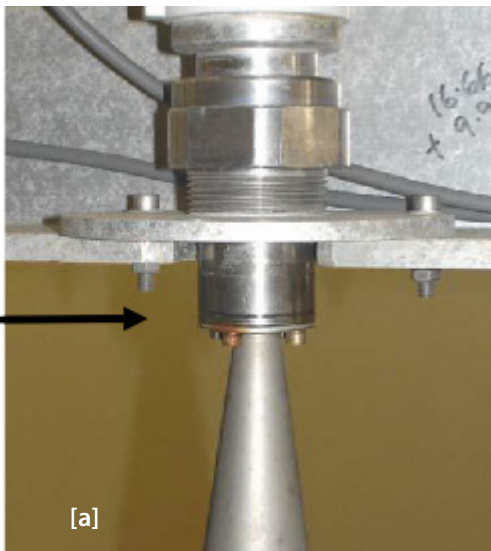

Figure 2. Reference marks on each gauge that we assumed initially would correspond to zero range.

- [a] Waterlog H-3611, black band between two sections of metal at the top of the horn,
- [b] OTT RLS, the face of the antenna, and
- [c] VEGAPULS-61, between the plastic and metal parts of the antenna.

holding the gauges and its attached stirrup, together with conventional levelling between the frame and nearby benchmarks, allowed us to relate the levels of reference marks of each the radars to each other and to the datum of the bubbler. Figure 2 shows the reference marks for the Waterlog, OTT and VEGAPULS gauges.

Using the 1.5 months of simultaneous measurements, we found that the data from the H-3611 were consistent with those from the National Network bubbler to within several mm on average, suggesting that the reference



Figure 3. Radar testing in the laboratory showing the same three gauges above the stirrup used at Holyhead. Separate tests were made with a water pool instead of the stirrup.

mark shown was indeed its zero (assuming no other datum error in the bubbler system). The effective zero of the OTT RLS was found to be approximately 1.5 cm beyond the reference mark shown on the face of the instrument. Unfortunately, the Holyhead data of the VEGAPULS-61 could not be used owing to an error during the installation.

Making use of the deployment of the stirrup, the recorded radar data implied that the target was 1.978 and 1.807 m beneath the H-3611 and RLS respectively, compared to distances measured by tape between reference marks and target of 1.981 and 1.823 m respectively. This implied again that the OTT RLS was measuring a range 16 mm too short and that the Waterlog was about right.

Tests in the Laboratory

After the above tests in the field, it was decided that additional testing should be undertaken to see if similar findings could be obtained in a laboratory environment. Two targets were used, one being the stirrup from Holyhead and the other a small water pool. Multiple measurements were made for each sensor, including the VEGAPULS-61 this time, varying the range between the sensor and the targets.

Figure 3 shows the RLS, H-3611 and VEGAPULS-61 installed on a frame above the stirrup, with the two outside sensors adequately distant from the frame supports. The height of the frame could be adjusted within a range 1-2.5 m above the target (stirrup or water pool), and each time it was moved, a spirit level was used to confirm that the frame was parallel to the target. The water pool was quite small, so the test was repeated twice so that the pool was directly under the RLS and the H-3611, and then under the H-3611 and VEGAPULS-61.

The H-3611 produced the most accurate and consistent results using both targets. At all ranges it was only ever out by a few mm with respect to the actual value measured by tape. These results were consistent with findings from the Holyhead tests. The RLS gave less satisfactory results with ranges for the stirrup as measured by the radar and tape differing by 1 to several cm. With the water pool they were slightly more consistent with differences spanning 15-24 mm for different ranges. The RLS beam of approximately 12° is wider than for the others, so the frame was moved so that it was situated more towards the centre of the target and hence further from the frame side-supports, with marginally better results. However, it appears that the RLS is less tolerant of its surroundings

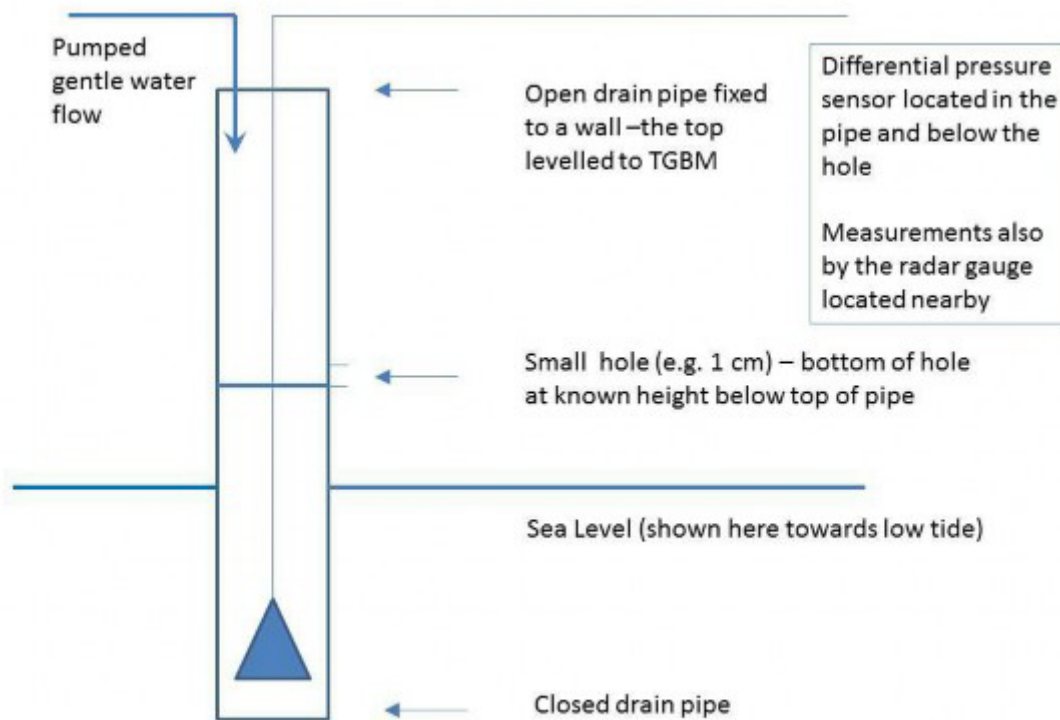

Figure 4. Schematic of the 'dribbler gauge' used to determine the effective datum of the H-3611 radar sensor.

than the other sensors, when investigated in a laboratory environment such as ours. The VEGAPULS-61 performed well with both targets. The stirrup yielded differences between radar and tape ranges between 3-8 mm, with 4-9 mm for the water target.

We concluded from the Holyhead and laboratory tests that, of the three radars under study, the H-3611 performed best overall, and provided sea level data that was compatible with other equipment (the bubbler), and this gauge eventually became our preferred choice. However, this good experience with one particular H-3611 cannot be assumed to apply to any other sensors we might use (H-3611 or otherwise). For example, Heitsenrether et al. (2012) found that the effective zeroes of different H-3611 gauges relative to a reference mark on their casings can vary by ± 1.5 cm. Therefore, we have decided that similar laboratory checks will have to be made with every new unit.

The Dribbler Gauge

Subsequently, we invented another way to determine the radar zero in the field, by using what we called a 'dribbler gauge' that works on a similar principle to the 'B gauge' pressure gauge (Woodworth et al., 1996;

IOC 2006). **Figure 4** shows a plastic drain pipe that is attached to the harbour wall. A plastic pipe cannot be expected to survive undamaged in the sea for long; it is intended only as a temporary installation. Unlike a stilling well, the pipe is closed at its bottom end but has a hole at roughly mid-tide which is at a known levelled height with respect to benchmarks. At low tide, the water in the tube is kept permanently topped up to the hole by dribbling in a stream of water. Of course, as the tide rises the water level in the tube is on average the same as outside. Inside the tube, below the hole, is a differential pressure sensor. Data from this sensor and the radar can then be compared tide-by-tide to determine the radar's effective datum in a similar way to the 'B gauge' method.

We installed such a pipe at Holyhead for two days in 2013 and employed the same H-3611 radar gauge we had used for the earlier studies. We found the effective zero of the radar determined this way was identical to that from the earlier field and laboratory studies. This particular instrument, now fully calibrated, was despatched for installation at Port Stanley, Falkland Islands as described below.

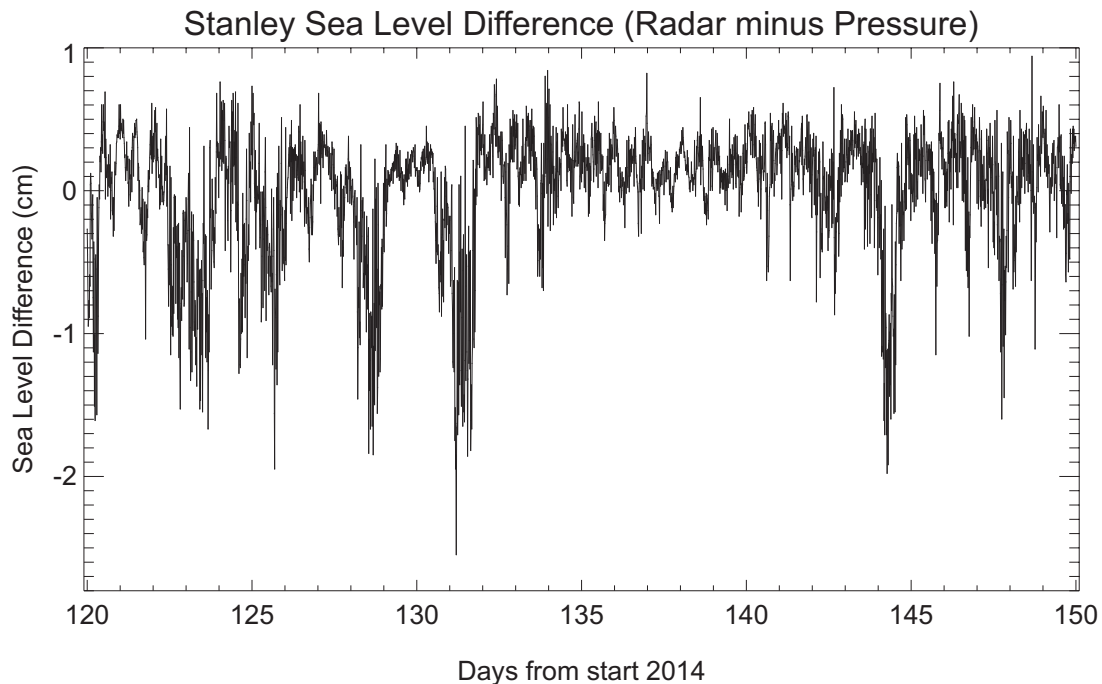

Figure 5. Differences between 15-minute values of sea level measured by the H-3611 radar and pressure gauges at Stanley during May 2014. There were several short periods of negative bias in the radar during winter months.

○ Tests of the H-3611 in the South Atlantic

We installed Waterlog H-3611 radar gauges at two locations in the South Atlantic: Port Stanley in the Falkland Islands and in English Bay, Ascension Island. The mean tidal ranges are approximately 0.9 and 0.6 m respectively. The wave climate is very different, the Stanley gauge being located in a sheltered harbour and the Ascension gauge on an open coast exposed to ocean swell.

The '1-minute' values at both places consisted of a single 420 msec measurement by the radar gauge followed by spot readings by the pressure sensors. These single readings once every minute mean that waves will be inevitably an important factor in the 1-minute data, which is why for most practical purposes we combine the 1-minute data into 15-minute averages.

(1) Port Stanley

The same H-3611 as used at Holyhead and in the laboratory tests was installed at Stanley in early 2014 at about 3 m above MSL. For the present study we have used data up to October 2014. Two OTT PLS differential pressure sensors were also installed, one set deep to measure the full tidal range and one at half-tide to make up a 'B gauge'. In brief, the 1-minute data from all the gauges were combined into 15-minute values and found to be in excellent agreement (few mm) for most

of the record. However, there were short periods of approximately half a day, when the radar sea level was lower than that of the pressure gauge by approximately 1-2 cm (Figure 5). These events were observed several times each month, mostly in the winter during the middle of the year. In these periods the high-frequency variability (or 'noise') in both systems was observed to be larger than normal, although with greater noise in the radar; the noise was calculated in terms of the maximum range between three 1-minute values in a 3 minute window. These periods were almost certainly when there were higher waves in the harbour than normal. However, in spite of the noise being larger for the radar, it is difficult to assign conclusively the 1-2 cm differences in Figure 5 to wave effects in the radar data alone. For example, it is impossible to identify cm-size signals in plots of tidal residuals from either the radar or pressure gauges, given that the residuals vary overall by ± 20 cm.

Nevertheless, the suggestion of a wave bias effect on the radar is consistent with our experience during the above-mentioned summer-time deployments of the H-3611 at Holyhead, when there were short periods with the radar reporting more negative sea level than the bubbler pressure gauge. Data from a nearby weather station confirmed that there were stronger winds than normal in these periods, and therefore there were likely to have been higher waves in the enclosed harbour (although the winds were only ~20 knots and so were mild compared

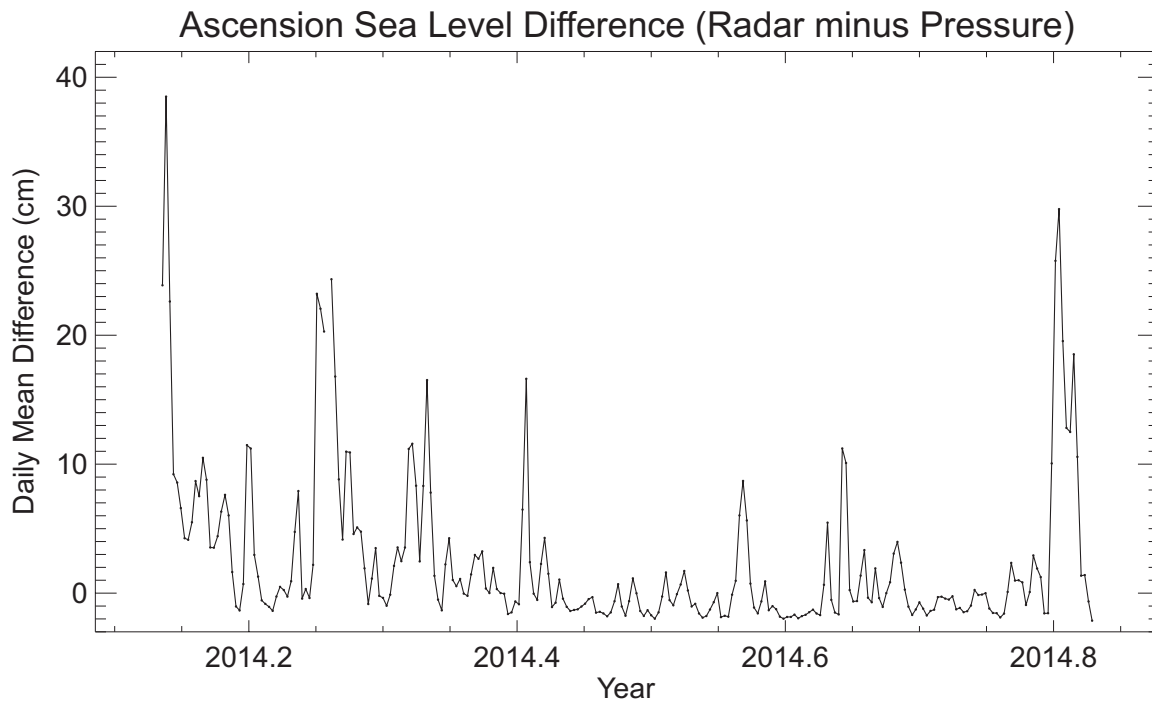

Figure 6. Differences between daily mean values of sea level measured by the H-3611 radar and pressure sensors at Ascension during 2014.

to those that would occur during a winter storm). Unfortunately, wave recorders were not available at either Holyhead or Stanley from which we could measure the wave heights that produced the apparent effects in the radar record. Transient positive and negative wave bias effects were observed for the H-3611 and other sensors by Heitsenrether et al. (2008). However, we are not aware of systematic negative wave bias such as that observed at Stanley having been reported elsewhere.

Therefore, our tentative conclusion is that wintertime waves at Stanley produce a negative bias in sea level measured by the H-3611 of the order of 1-2 cm. In summary:

- ✓ The consistency of measurements at Stanley with a radar gauge that had previously been used and calibrated at Holyhead and Liverpool confirmed that a properly-calibrated sensor can be reliably operated at a distant site.
- ✓ We consider the H-3611 to work well and we can operate with the above-mentioned uncertainty in level due to waves. The impact on daily values will be ~1 cm maximum and on monthly values it will be only a few mm.
- ✓ However, we believe it is essential to keep the PLS gauge so as to maintain a continuous check on the radar measurements.

- ✓ Without the PLS system we would have to initiate regular tide pole measurements so as to ensure the long term datum of the radar measurements.

(2) English Bay, Ascension Island

An installation with the same type of Waterlog radar and OTT pressure gauges was made at Ascension at almost the same time in 2014. Its H-3611 had been calibrated previously using the fixed laboratory target in the same way as for the Holyhead/Stanley H-3611. In this case, the radar was located approximately 3.5 m above MSL and exposed to larger waves than at Stanley. On the days when wave activity was low (as we can determine from the standard deviation and skewness of 1-minute values within half or one-hour windows), then the two systems were consistent at the several mm level. However, on the days with waves, radar sea levels were considerably larger than those from the pressure gauge. Even when data were combined into 15-minute averages, the radar level could exceed that from the pressure gauge by 10-20 cm over an extended period, which is then also represented in the daily mean values (Figure 5).

Clearly the radar data in this case are unacceptable. We suspect their high values are due to reflections off spray. This situation contrasts with our previous radar data from the same site obtained with a VEGAPULS-61 sensor. That radar gauge was operated for several years with good consistency with the pressure gauges. For the present

study, we have looked once again at VEGAPULS-61 data spanning 2008-2009, for which differences of 15-minute values of sea level obtained from the radar and pressure sensors have a root-mean-square (rms) of several cm, increasing to approximately 10 cm during what was presumably a period of greater wave activity in the first two months of 2009. Daily values of sea level difference have an rms of the order of only 1 cm, while the time series of sea level difference suggests a negative bias in radar values of approximately 1 cm in those two months in 2009.

These findings are consistent with laboratory tests of the various devices which have shown that the VEGAPULS-61 is a heavily damped measuring device (e.g. Heitsenreth and Davis, 2011), so any rapid signals from waves and spray may be significantly attenuated. In summary, we have concluded for Ascension:

- ✓ If a radar gauge is required at this site, then it would be best to put back a VEGAPULS-61.
- ✓ Alternatively, we could consider continuing to operate the H-3611 but positioned higher above the water although this would be somewhat difficult to engineer at this site.
- ✓ However, if either the H-3611 or VEGAPULS-61 are used, we should move to a sampling more like 60 times per minute than the once per minute we have employed so far.
- ✓ Regular tide pole measurements at this site are not an option owing to few local people who might be called upon and because of the many days with waves (although extended historical tide pole measurements at the site exist do exist obtained by the US Naval Hydrographic Office).
- ✓ Consequently, it will be essential to continue having a pressure-based system at Ascension operating in parallel to the radar.

○ Test of the OTT RLS at St. Helena

An OTT RLS gauge was installed in Jamestown Bay in St. Helena at the start of 2011, accompanied by a pressure sensor from January 2012. All devices operated well until February 2013 when the station was damaged in a storm.

Jamestown Bay has an almost constant exposure to distant swell, with occasional major storms, and so the data from the radar gauge might be expected to be

affected significantly by waves. However, the radar's 1-minute data were in fact found to be less noisy than those of the pressure sensor, even though the latter had been installed in a mini-stilling well. At present, we understand this to be a consequence of the '1-minute' values of the pressure gauge being spot measurements, while those from the RLS are averages over approximately 30 seconds (see above).

After all data were averaged into 15-minute values, the radar and pressure sea level data were found to be similar (with the latter still noisier), with an average rms in their difference of typically 5 cm, increasing to more than 10 cm during particular noisy periods which we assume to be periods of higher wave activity. Negative excursions of the radar values, compared to those from the pressure sensor, of approximately 10 cm occurred at these times of greater noise, which we attribute to negative wave bias. This experience is similar to that described above for the H-3611 at Stanley although with a larger negative bias. No major positive spikes due to waves of the kind found for the H-3611 at Ascension (**Figure 5**) were observed. A preliminary conclusion is that the RLS could be employed long-term at this site for MSL and other tidal purposes in combination with pressure sensors.

○ Conclusions

Radar gauges have many advantages over other tide gauge technologies. However, to be useful for all sea level studies, including those of long-term MSL, they must be calibrated so that their effective zero range is known with respect to a reference mark on the unit. This effective zero can then be related to the heights of benchmarks nearby by levelling.

We have demonstrated several laboratory and in situ methods, whereby the gauge can be calibrated either before or after it has been installed. More conventional methods to determine the zero include obtaining tide pole measurements at the same time as the radar is measuring (with the pole levelled to benchmarks), or dipping measurements in an adjacent stilling well where one exists. However, these conventional methods may not be feasible at remote locations and are probably less accurate than the ones we have described, especially when there are large waves. It would be far better for a gauge to be calibrated before it is installed and thereafter rely on a radar's stability, perhaps with occasional tide pole checks.

We have also shown that waves can result in a loss of accuracy, and a systematic bias (usually negative), in radar measurements. However, the extent of the problem is different in different places. Wave effects almost certainly depend on the particular gauge type, its installed height above the sea, and many other technical and environmental factors.

One task for us is to revisit further the decade of OTT Kalesto data we have from Stanley, and about 7 years of VEGAPULS-61 data at Ascension, together with measurements by different radars at Gibraltar and Liverpool (Vega and OTT Kalesto), all in combination with pressure sensors. Throughout this time, we have employed the pressure sensors (either 'B gauges' or bubbler gauges) as the primary systems with the radars as secondary instruments. When data sets have been compared, then no major wave effects, such as those described above for the H-3611, have been identified, but that situation needs to be reinvestigated.

However, for the moment, we can summarize from our previous experiences with radar gauges (e.g. Woodworth and Smith, 2003), and from our recent findings at Holyhead and in the South Atlantic, that radar may indeed work well at particular sites. However, there is no guarantee that the same sensors will perform equally well at all sites (e.g. the H-3611 appears to work well at Stanley but the VEGAPULS-61 is more suitable at Ascension). We have learned that it is imperative to undertake measurements with several gauge types in parallel until one can arrive at an opinion on which sensor, or technique (e.g. radar or pressure), or combination of techniques works best at each site. For example, we need to extend our research to the use of guided wave radars for low wave environments such as at Rothera, Antarctica.

Finally, we can point out that a single group such as ours can be expected to test only a small number of radar gauges at a limited number of locations. Much more research and greater shared experiences are needed. This manual will go a long way in that respect. However, collaborative inter-comparison studies, such as that at Vilagarcía de Arousa over a decade ago (Martín Míguez et al., 2005), organized by GLOSS on a regional basis, would be highly desirable. The shared costs in such experiments would enable the sites to be instrumented as fully as possible in order to understand the many subtle influences on the radar measurements.

○ References

- Boon, J.D. 2014. Reducing wave-induced microwave water-level measurement error with a least squares-designed digital filter. *Journal of Atmospheric and Oceanic Technology*, 31, 481-502, doi:10.1175/JTECH-D-13-00160.1.
- Heitsenrether, R.M., Bushnell, M.H. and Boon, J.D. 2008. Understanding the impact of surface waves on microwave water level measurements. *MTR/IEEE Oceans 2008 Conference and Exhibition*, Québec City, Canada, 15-18 September 2008. 9pp.
- Heitsenrether, R. and Davis, E. 2011. Test and evaluation report. Limited acceptance of the Design Analysis WaterLog H-3611i microwave radar water level sensor. NOAA Technical Report NOS CO-OPS 061.
- Heitsenrether, R., Hensley, W. and Krug, W. 2012. Measurement requirements for radar water level sensor laboratory verification tests. NOAA Internal Report. 8pp.
- IOC, 2006. *Manual on Sea-Level Measurement and Interpretation. Volume 4: An Update to 2006. Intergovernmental Oceanographic Commission Manuals and Guides No. 14.* Paris: UNESCO/Intergovernmental Oceanographic Commission.
- Mai, S. and Zimmermann, C. 2000. Applicability of radar level gauges in wave monitoring. *Proceedings of the 2nd International Conference on Port Development and Coastal Environment*, Varna, Bulgaria, 2000.
- Martín Míguez, B., Pérez Gómez, B. and Álvarez Fanjul, E. 2005. The ESEAS-RI sea level test station: Reliability and accuracy of different tide gauges. *International Hydrographic Review*, 6, 1. 2-11.
- Woodworth, P.L., Vassie, J.M., Spencer, R. and Smith, D.E. 1996. Precise datum control for pressure tide gauges. *Marine Geodesy*, 19(1), 1-20.
- Woodworth, P.L. and Smith, D.E. 2003. A one-year comparison of radar and bubbler tide gauges at Liverpool. *International Hydrographic Review*, 4(3), 42-49.

Recent Test, Evaluation, and Operational Use of Radar Water Level Sensors by the United States National Oceanic and Atmospheric Administration

Robert Heitsenrether¹ and Richard Edwing²

¹ NOAA, 672 Independence Pkwy,
Chesapeake, Virginia, USA 23320

² NOAA, 1305 East West Highway, Bldg SSMC4, Room 6650,
Silver Spring, Maryland 20910, USA

Contact: R. Heitsenrether

E-mail: robert.heitsenrether@noaa.gov

○ Introduction

The United States National Oceanic and Atmospheric Administration (NOAA) National Ocean Service (NOS) Center for Operational Oceanographic Products and Services (CO-OPS) maintains and continues to develop over 300 real-time coastal observatories, which make up the National Water Level Observation Network (NWLON) and Physical Oceanographic Real-Time Systems (PORTS®), throughout the United States. NWLON consists of over 200 coastal stations that provide real-time water level observations throughout the U.S. coastal regions, including the Great Lakes, as well as Pacific and Caribbean island territories. To ensure that its real-time observing network operates in the most efficient way possible and provides the most accurate and up-to-date products and services available, CO-OPS keeps abreast of evolving measurement technology and invests in extensive research, development, testing, and evaluation (RDT&E) of the latest oceanographic instrumentation.

Motivated by the many advantages of radar water level sensor technology and initial success of many users throughout the international water level observing community, CO-OPS has been investing in the RDT&E of radar sensor-based measurement systems over the past 15 years. Applications include measuring clearance beneath bridges for safe passage of ships below, and more recently, measuring water level in NOAA's long-term, real-time monitoring systems throughout the coastal U.S. CO-OPS began using radar sensors operationally for bridge clearance measurements at PORTS observatories starting in 2005 and for water level monitoring throughout NWLON and PORTS starting in 2011.

This article provides a brief synopsis of CO-OPS RDT&E efforts conducted with radar water level sensors to date, along with a status update on efforts to transition these sensors to operational applications across the CO-OPS NWLON network. More detail on topics discussed can be found in the references listed at the end of this article.

○ Air Gap

CO-OPS' first experience with radar sensors in maritime field applications involved the development of the PORTS bridge clearance (air gap) measurement system. System development and testing was conducted in the early 2000s, and the transition to operations was completed in 2005 (Bushnell et al. 2005). The purpose of this system

is to provide real-time measurements of the vertical distance from a bridge's lowest structural component above the shipping channel (commonly referred to as low steel) to the water level surface below, which gives vessel pilots decision-support information that decreases the likelihood of vessel collisions with bridges.

The initial PORTS air gap system employed the Miros SM-094, which was recently replaced by model SM-140. The sensor employs a frequency-modulated continuous-wave (FMCW) signal with a 9.4-9.6 gigahertz (GHz) triangular waveform. The sensor uses signal processing methods to measure the phase shift between the transmitted signal and received reflections from the water surface to derive a range-to-surface measurement.

Since the initial installation of the first two PORTS air gap systems in 2005 on bridges over the Chesapeake and Delaware Canal, air gap systems have gained wide popularity due to demonstrated reliability and value of data provided (Bushnell et al. 2005). The number of currently operating PORTS air gap systems has grown to thirteen, with three additional systems planned for installation during 2016. Experience and lessons learned throughout the continued installation and maintenance of air gap systems led to development and implementation of multiple system improvements.

Following an additional market survey of commercial, off-the-shelf (COTS) radar sensors and additional testing to support water level applications (discussed in the following section), CO-OPS began using the Xylem\ WaterLog H-3612 radar sensor in air gap systems, in addition to the Miros SM-094 (Heitsenrether and Hensley 2013). The model H-3612 transmits a series of short pulses at 26 GHz and uses the time-of-flight of return signals to measure range, as opposed to the FMCW signal employed by Miros. As a result of the short-pulse signal type, the H-3612 has a significantly lower power requirement, which can be advantageous in installations with no access to 110 alternating current power and limited space for extra batteries and solar panels. Although the Miros sensor is still optimal in some locations, particularly where the maximum range exceeds 64 meters (m) (210 feet [ft]), having two radar sensor types provides more options for handling site-specific design challenges in a broad range of prospective deployment locations.

○ Water Level

The primary water level measurement system at most NWLON stations over the past twenty years has been the Aquatrak acoustic time-of-flight range sensor. This water level system includes the acoustic transducer mounted above the water surface (e.g., atop a pier, piling, seawall, or other structure extending over the water) and a narrow sounding tube enclosed in a 15-centimeter (cm) (6-inch [in]) PVC well that extends down into the water column (Edwing 1991). The system's well can require a significant amount of mounting hardware depending on the installation location. Additionally, the well has subsurface components that require dive operations for installation and maintenance. At many locations, the well can be greater than 9 m (30 ft), and mounting hardware required to maintain vertical stability can be complex, expensive, and time consuming to install. Another disadvantage to an Aquatrak system with well lengths that exceed 6 m (20 ft) is measurement error induced by vertical temperature and sound speed gradients along the sounding tube (Porter and Shih 1996; Hunter 2003). Although the Aquatrak system has clearly served NWLON well for over twenty years, emergence of the radar water level sensors with substantially reduced installation and maintenance costs provided clear motivation for the long-term development, test, and evaluation effort.

While developing the PORTS air gap system throughout the early 2000s, CO-OPS kept close attention to reports on several efforts being pursued throughout the international water level community related to the development, test, and operational use of radar sensors for long-term water level monitoring (Barjenbruch et al. 2002; Blasi 2009; Woodworth and Smith 2003; Fulford and Davies 2005; Fulford et al. 2007; Martin et al. 2005; Martin et al. 2008; Gronlie, 2004; Boon and Brubaker 2008). Motivated by the initial successes conveyed in some listed references and the many operational advantages offered by radar water level sensor technology, CO-OPS began the official pursuit of test and evaluation of radar for water level applications in 2007.

CO-OPS completed a high level radar water level test and evaluation plan in 2007 (Bushnell and Boon 2009). Following the completion of this plan, a series of extensive laboratory and field tests commenced during 2008, and several associated, long-term field tests remain ongoing at the time this article was written. This suite of NOAA radar water level testing that has been conducted and extensively reported over the past eight years is

commonly classified into distinct phases and referenced accordingly. Phase I testing followed the 2007 plan from 2008-2011. Results led to CO-OPS' limited acceptance and initial transition to operations in low-wave-energy environments (Heitsenrether and Davis 2011; Landon and Heitsenrether 2012). Phase II testing was motivated by several technical reviews and discussions on results obtained from Phase I tests. Additional tests were conducted and included a series of laboratory and closed-field experiments aimed at clarifying the internal operational characteristics of the sensor. Then, a set of open-field data collections followed to provide data in the intermediate- and high-surface energy regimes. Phase II testing started during 2012 and continues to date at particular field locations. Results were reported during 2013 and 2014 (Park and Heitsenrether 2013; Park et al. 2014).

A high-level summary of the main components from each testing phase, along with primary findings, is found in the following two sections. The list of references provided with this article contains details on related testing activities and results. The article concludes with a brief description of CO-OPS' plan and approach to the ongoing transition of radar sensors to operations across the NWLON network.

Phase I Testing

In 2008, CO-OPS started its first series of laboratory and field testing to assess the long-term water level monitoring capability of radar sensors following the 2007 test plan (Bushnell and Boon 2009). Initial tests included sensors from four different manufacturers: 1) Miros SM-094; 2) Design Analysis WaterLog® H-3611i; 3) Ohmart/VEGA VEGAPULS 62; and 4) the Sutron RLR-0002. Based on results from data collected over approximately the first 2.5 years of testing, CO-OPS identified the Design Analysis WaterLog® H-3611i (now the Xylem\WaterLog H-3611 and subsequently referred to as WaterLog) as the best suited of the four selected sensors for CO-OPS measurement applications at this time. It is clearly noted here, however, that all four sensors demonstrated good performance and yielded similar accuracy. CO-OPS recognizes that several documented studies indicate that other institutions/organizations have been successful in collecting accurate, high-quality water level observations using radar sensors other than the WaterLog unit. NOAA in no way endorses one tested sensor or one manufacturer over another for general applications.

Selection of the WaterLog as the sensor best suited for NOAA at this point is based on quantitative criteria specifically designed with CO-OPS' unique operations and applications in mind, as well as specific aspects of each sensor operating within this application. Testing of newer versions of the other three radar sensors, as well as those from other manufacturers, will certainly continue, and the other sensors may still be considered for use in CO-OPS' operational water level stations.

A summary of the major Phase I testing components, as well as primary findings, is included in the following bullets (Park and Heitsenrether 2013b; Park et al. 2014):

Lab Tests Conducted

- ✓ Series of basic functional tests at Chesapeake, Va. facility – range accuracy, time response, long-term stability (Heitsenrether et al. 2009).
- ✓ Temperature response test at the U.S. Geological Survey (USGS) Hydrologic Instrumentation Facility (HIF) temperature chamber (Heitsenrether et al. 2009).
- ✓ Surface wave response testing at the U.S. Naval Surface Warfare Center (NSWC) Maneuvering and Sea Keeping Basin (MASK) wave tank facility (Heitsenrether et al. 2008).

Lab Test Results

- ✓ In a controlled environment with ideal target (flat metal sheet), all radar sensors consistently meet range measurement accuracy specifications over 1-10 m (3-33 ft).
- ✓ The physical location of the sensors' true zero range point varies from sensor to sensor and is typically ± 1 -1.5 cm (± 0.4 -0.6 in) (above or below) where the manufacturers claim it to be. This motivated preparation of a standard procedure to measure a 'sensor offset' in a short range-to-target setup prior to field deployment.
- ✓ Sensors have a variety of processing settings that result in the automatic application of a range of different internal averaging/filtering and time response characteristics. For some models, the process to configure sensor settings to obtain raw 1 Hz range samples was not straightforward and required a little extra effort.
- ✓ Sensors' range measurements remained very stable and remarkably insensitive to ambient temperature variations ranging from -20 °C to 50 °C.

- ✓ From the NSWC MASK wave tank test:
 - o The presence of continuous, regular, short wavelength waves resulted in a range offset, or bias in all sensors' measurements. These wave-induced offsets showed a dependency on wavelength/sensor footprint ratio and only occurred in the presence of continuous, regular wave trains with wavelengths significantly shorter than the radar sensors' footprint width on the water surface.
 - o During all test runs involving waves generated over a broad range of frequencies (more representative of real conditions in the field), all sensors performed well and with measured water levels in the presences of waves remaining within ± 1 cm (± 0.4 in) of range values with a calm surface (with no signs of a wave induced offset).
 - o Some sensors' processing configurations were initially configured to apply automated temporal averaging/filtering. In the presence of waves, sensors that employed automated temporal averaging produced poor results, while sensors that provided raw, fast response 1 Hz samples, produced significantly better results. Little detail is known about the algorithms behind the sensors' various temporal averaging options, but results indicated they are most likely not ideal for tracking the ocean's average surface in the presence of waves.
 - o Based on the result described above, CO-OPS recommends either configuring all radar sensors to sample fast response, raw 1 Hz range data and then applying selected averaging/filtering method in post processing, or working with sensor manufacturers to implement a custom, user-specified averaging/filtering algorithm in the sensor. Boon (2014) describes such a filter specifically designed for this application.

Field Testing Conducted

In 2008, test radar sensors were installed at three different locations with varying coastal environments: Duck, N.C.; Port Townsend, Wash.; and Fort Gratiot, Mich. Analysis of the first year of field data collected at the three sites provided further insight into the environmental variability experienced at each test location, and results suggested that testing in additional environments would help to

achieve project objectives (Heitsenrether et al. 2011). As a result, radar water level sensors were deployed for testing at additional sites including Bay Waveland, Miss. (January 2010) and at three locations throughout the Elizabeth River area of the South Chesapeake Bay, Va.: Money Point (March 2010), the Lafayette River (February 2011), and the Western Branch (February 2011). Each field test site is located near an NWLON station, so at least one reference water level sensor is available, along with basic meteorological measurements, to assist in characterizing environmental variability.

Field Test Results

- ✓ Application of CO-OPS' specific sensor selection criteria to the extensive radar water level test data suggests that the WaterLog is best suited at the present time for meeting CO-OPS' unique mission requirements, data acquisition operations, and data products and services. Several key features that led to CO-OPS selection of the WaterLog are provided in the introduction section of Heitsenrether and Davis (2011).
- ✓ Comparison of test radar sensors and operational NWLON acoustic sensors find statistically equivalent performance at stations with little or no surface impact from wave energy and small thermal gradients along the sounding tube – Port Townsend, Fort Gratiot, and the three Elizabeth River area sites.
- ✓ At the Duck, N.C. site, with surface waves persistently larger than roughly 0.5–1-m significant wave height, monthly-mean water levels consistently reveal lower levels observed by the acoustic sensor. Boon et al. (2009) also reported differences between the acoustic and radar system response with wave conditions, and Boon and Hensley (2012) as well as Boon (2014) presented evidence of the radar's asymmetric water level distribution in the presence of surface waves.
- ✓ Monthly WaterLog versus Aquatrak root mean squared differences (RMSDs) at Duck covering periods of large wave events were as large as 7 cm (2.75 in), and differences between individual 6-minute water level measurements sometimes exceeded 10 cm (4 in) (Heitsenrether and Davis 2011; Boon and Hensley 2012; Boon 2014).
- ✓ Data collected simultaneously from four collocated radar sensors at the Duck, NC test site showed that precision within the group of sensors depended

on zero-moment (Hm0) wave height. Different pre-filtering methods applied to 1 Hz data before calculating 6 minute averages were shown to improve inter-sensor precision (Boon 2014).

- ✓ Understanding deviations between water levels measured by operational NWLON acoustic sensors and test radar sensors in the presence of a dynamic, open ocean environment such as Duck remains a work in progress that requires additional related field testing and analysis.

Based on all Phase I test results, proceeding with a transition of radar sensors to operations was recommended, while initially taking a conservative approach. At first, operational use of radar sensors was limited to low wave energy NWLON station sites. This decision was not to suggest that radar sensors cannot meet operational performance requirements in higher energy wave environments but rather an indication of NOAA's limited supporting field test data, along with a lack of thorough understanding of the radar sensor's performance over a broad range of ocean wave conditions.

Phase II

Experience with the WaterLog from 2007-2011 prompted additional questions to be raised concerning the operational characteristics of this sensor. A series of technical reviews and discussions led to consensus that two components of additional testing were warranted. First, a series of laboratory and closed-field experiments were conducted aimed at clarifying the internal operational characteristics of the sensor; and second, a set of open-field data collections co-located with NWLON Aquatrak sensors and independent wave gauges provided data in the intermediate- and high-surface energy regimes.

A summary of the major components of Phase II testing with the WaterLog radar and primary findings includes:

Lab Tests Conducted

- ✓ Radar beam sidelobe interference
- ✓ Transmission medium scattering
- ✓ Temperature cycles and ice
- ✓ Impacts of horn antenna cover
- ✓ Horn antenna weather shield

Lab Test Results

- ✓ The projected beam pattern of the sensor forms an ellipsoidal footprint with a major and minor axis dimensions that are different by a factor of 2. The spreading angles have been quantified with measurements, and should be considered in the design of field installations to prevent sidelobe interference.
- ✓ Water droplets between the sensor and target, as can reasonably be expected to occur in field conditions, have an impact on sensor performance.
- ✓ Frost/ice accumulation in the antennae can significantly degrade sensor performance.
- ✓ Ice accumulation on the sensor housing (not inside the antennae) does not appear to impact sensor performance.
- ✓ The sensor typically recovers from degraded performance due to ice in the antennae when the ice melts; however, there is an indication that condensation inside the electronics housing can degrade the sensor performance.
- ✓ The antennae horn cover (end cap) solves the problem of frost/ice accumulation inside the antennae, but introduces a new problem when modest amounts of moisture or ice on the end cap surface degrade sensor performance.
- ✓ A weather shield to prevent precipitation on the antenna is recommended.

Field Tests Conducted

Four NWLON station sites were selected for Phase II field testing based on comparison of empirical cumulative distribution functions (ECDF) of water level standard deviation over a period of 1 year. Plots showing results of water level standard deviations across multiple NWLON station sites are shown in Park and Heitsenrether (2013). The four NWLON stations selected for new radar sensor test installations with intermediate- to high-energy wave environments were: Duck, N.C. (re-installation); Lake Worth, Fla.; La Jolla, Calif.; and Monterey, Calif.

Data collected at each site included: 1 Hz range measurements from both the operational NWLON acoustic sensor and the test radar sensor; half hourly wave bulk parameters and spectra from a Nortek Acoustic Waves and Currents (AWAC) sensor; 6-minute samples of

average wind speed and direction; 6-minute average air temperatures near the top and bottom of the Aquatrak well's sounding tube.

Field Test Results

Analysis results from data covering a total period of 19 months at Phase II test locations were reported in 2014. Data collection at the four sites was still ongoing, along with continued analysis efforts at the time this summary article was written. The primary results reported to date are as follows (Park et al. 2014):

- ✓ The majority of Aquatrak versus radar water level differences are due to systemic errors in the Aquatrak system including:
 - o Temperature-induced speed-of-sound errors
 - o Wave- and current-induced hydraulic pressure errors
 - o Buoyancy-driven water level resonance
- ✓ Radar sensor captures water level variability with higher fidelity than the Aquatrak when waves are present.
- ✓ Further analysis is needed to attribute infragravity responses of the Aquatrak system that deviate from previously developed protective well draw-down models when waves or currents are large.
- ✓ When temperature or wave forcings are present, the radar sensor is a more accurate water level sensor than the Aquatrak.
- ✓ Results of this study do not constitute a general recommendation to replace acoustic sensors with radar sensors. Just as the acoustic system has limitations from temperature and hydraulic draw-down effects, radar sensors have limitations such as sidelobe interference, false targets, and signal scattering from heavy rain. Such an assessment is a site-specific determination, and should include long-term comparisons of sensor data.

○ Plans for Long-Term Transition to Operations across NWLON

With two extensive data sets from Phase I and II providing quantitative evidence of radar water level sensors performance capability, along with many benefits over the acoustic system, CO-OPS has developed a plan to transition to radar sensors at most of its NWLON stations.

Since 2011, CO-OPS has transitioned radar water level sensors to operations in three different applications: existing long-term NWLON stations, temporary stations supporting hydrographic surveys, and newly constructed or rebuilt stations. Since 2011, radar water level sensors have been installed at more than twenty short-term stations (hydrographic and vertical datum transformation software [VDatum] support), six existing long-term NWLON stations for one- year overlap, and six new long-term stations.

CO-OPS plans ten to twenty radar water level upgrades to NWLON stations per year with a three-year cycle per station.

- ✓ Year 1 - Purchase equipment, perform reconnaissance, and design.
- ✓ Year 2 - Install radar water level sensor and collect one year of overlapping data record.
- ✓ Year 3 - Remove legacy primary sensor and components (well).

During the transition, CO-OPS will operate both radar water level sensors and existing acoustic and pressure sensors concurrently for one year, if possible, to ensure the stability, continuity, and consistency of data. To make sure the systems perform satisfactorily in varying operational conditions for more than one year, CO-OPS also will conduct long-term comparisons for at least five years at ten NWLON stations. This requirement is driven internally and by the international Global Sea Level Observing System/climate community to ensure the continuity of the data record throughout the transition to a new sensor technology.

To support the transition to operations and the planned increase in radar water level sensor usage throughout NWLON and PORTS, CO-OPS developed a standard radar water level sensor pre- deployment laboratory test procedure designed to significantly decrease the likelihood of problems during field deployment. The procedure is based on extensive test results, including

problems encountered and lessons learned. Efforts to create an associated permanent laboratory facility are underway.

Transitioning the radar sensors has also involved the development of a series of new sensor mounting hardware for use on operational installations. Several new types of horizontal extension arms to accommodate the sensors' 10° dispersive beam have been designed and implemented, as well as a geodetic leveling collar to enable survey rods and/or tapes to be consistently located to a leveling point that can easily be referenced to the sensor's zero range point. The WaterLog sensor's zero range point is referenced to the bottom of the circular flange that is used for mounting the sensor. However, because the width of the sensor's electronics housing is larger than the diameter of its flange, a survey leveling rod cannot be set atop the flange such that the rod is straight/vertically level. If the sensor's zero point is referenced to the bottom of the circular flange, the sensor can be mounted so that this flange bottom sits flush against another flat, metal surface, providing additional area for rod placement at the same vertical location as the sensor's flange bottom.

At the time this article was being prepared, CO-OPS has completed approximately 52 operational deployments with radar water level sensors: 32 at long term, permanent stations and 20 at short term, temporary stations. Out of the 32 long term deployments, 12 involve deployments at NWLON stations. Updates on analysis results from one year overlapping records (of new radar sensors and existing NLWON sensors) and plans to proceed with technology transition at long term NLWON stations will be provided in subsequent reports and meeting presentations.

○ Summary

Motivated by the many advantages offered by radar water level sensors, CO-OPS has been pursuing a long-term development, test, and evaluation effort for NWLON applications over the past eight years. A main component of this effort has involved collecting an extensive data set over a variety of different coastal environment types. Since the number and variety of important applications for CO-OPS water level data continue to increase, a critical challenge during a sensor technology transfer is ensuring the continuity, reliability, and quality of existing stations' proven long-term data records.

From a cost, maintenance, and support perspective, the radar system is significantly more efficient than the acoustic system, since the radar requires no infrastructure in contact with the water, although it has limitations to be considered. These limitations include the potential for erroneous water levels from flotsam or surface ice within the footprint and degradation of sensor performance caused by ice accumulation in the antenna and scattering from heavy rain. The extensive lab and field data set collected and successful test results obtained to date have supported NOAA's long-term plan to transition the primary water level sensor at most tide stations in the NWLON from acoustic to radar systems. Results from ongoing long-term field tests, along with results and lessons learned throughout the sensor technology transfers across NWLON, will continue to be reported periodically.

References

- Barjenbruch, U., S. Mair, N. Ohle, U. Mertinatis. 2002. Monitoring of water level, waves, and ice with radar gauges. In: Hydro 2002 Conference, Kiel: Hydrographic Society Benelux.
- Blasi C. 2009. A new technology for the measurement of the sea level and the sea state. *Environ. Geol.*, 57(2).
- Boon, J.D., J.M. Brubaker. 2008. Acoustic-microwave water level sensor comparisons in an estuarine environment. In: Oceans 2008 International Conference, Quebec City, Canada: Marine Technology Society/IEEE.
- Boon, J., R. Heitsenrether, and M. Bushnell. 2009. Microwave-acoustic water level sensor comparisons: sensor response to change in oceanographic and meteorological parameters. In: OCEANS 2009 International Conference, Biloxi, MS: IEEE/OES.
- Boon, J. and W. M. Hensley, 2012. Multi-sensor evaluation of microwave water level error. *Proc. Oceans* 12, Hampton Roads, VA, MTS/IEEE, 8 pp., doi:10.1109/OCEANS.2012.6405079.
- Boon, J. 2014. Reducing wave-induced microwave water-level measurement error with a least squares-designed digital filter. *J. Atmos. Oceanic Technol.*, 31, 491-502.
- doi: <http://dx.doi.org/10.1175/JTECH-D-13-00160.1>
- Bushnell, M., K. Bosley, and T. Mero, 2005. Microwave Air Gap Bridge Clearance Sensor Test, Evaluation, and Implementation Report, NOAA Technical Report NOS CO-OPS 042, Center for Operational Oceanographic Products and Services, National Ocean Service, NOAA, Silver Spring, MD.
- Bushnell, M. and J. Boon, 2009. (Internal version completed in 2007). Microwave Water Level Sensor Operational Capability Test and Evaluation Plan, NOAA Technical Report NOS CO-OPS 052, Center for Operational Oceanographic Products and Services, National Ocean Service, NOAA, Silver Spring, MD.
- Edwing, R., 1991: Next generation water level measurement system NGWLMS site design, preparation, and installation manual. U.S. Department of Commerce NOAA NOS CO-OPS Technical Report. 220 pp.
- <http://tidesandcurrents.noaa.gov/publications.NextGenerationWaterLevelMeasurementSystemMANUAL.pdf>.
- Fulford, J.M. and W.J. Davies. 2005. Radar water level measurement for open channels. In: Proceedings of Third International Conference on Irrigation and Drainage. San Diego, CA: USCID.
- Fulford J.M., L. Ester, and J.W. Heaton. 2007. Accuracy of radar water level measurements. Hydraulic Measurements and Experimental Methods Conference, Lake Placid, NY: ASCE.

- Gronlie, Oistein. 2004. Wave radars – a comparison of concepts and techniques. *Hydro International*. 8(5).
- Heitsenrether, R., M. Bushnell, and J. Boon, 2008: Understanding the impact of surface waves on microwave water level measurements. In: *OCEANS 2008*, Quebec City, QC: IEEE/OES.
- Heitsenrether R, Bushnell M., Krug W. 2009. Microwave water level sensor test and evaluation interim report #1. NOAA Technical Report NOS CO-OPS Report 054, Center for Operational Oceanographic Products and Services, NOS, NOAA, Silver Spring, MD.
- Heitsenrether, R. M. and E. Davis, 2011: Limited acceptance of the design analysis Waterlog H-3611i microwave radar water level sensor. U.S. Department of Commerce, NOAA Technical Report NOS CO-OPS 061. 55 pp.
http://tidesandcurrents.noaa.gov/publications/Technical_Report_NOS_CO-OPS_061.pdf
- Heitsenrether, R.M., W.M. Hensley, and J.D. Boon. 2011. Results from NOAA's test and evaluation of microwave radar water level sensors and plans for a transition to operational applications. In: *MTS/IEEE OCEANS 2011*. Waikoloa, HI: MTS/IEEE.
- Heitsenrether, R. and W. Hensley. 2013. Test and evaluation report for WaterLog® H-3612 radar sensor in CO-OPS air gap applications. Department of Commerce, NOAA Technical Report NOS CO-OPS 072. 65 pp.
- Hunter, J. R., 2003: On the temperature correction of the Aquatrak acoustic tide gauge. *J. Atmos. Oceanic Technol.*, 20, 1230–1235.
- Landon, T.F. and R. Heitsenrether. 2012. New real-time storm surge monitoring network in Mobile Bay, Alabama. In: *Conference Proceedings of OCEANS 2012*, Virginia Beach, VA: MTS/IEEE.
- Martin B.M., G.B. Perez, and F.E. Alvarez. 2005. The ESEAS-RI sea level test station: reliability and accuracy of different tide gauges. *Int. Hydrogr. Rev.* 6(1), pp. 44-53.
- Martin B.M., R. Le Roy, and G. Woppelmann. 2008. The use of radar tide gauges to measure variations in sea level along the French coast. *J. Coast. Res.*, 24(4C), 61-68.
- Park J., and R. Heitsenrether. 2013(b) WaterLog H-3611i Test Results Part I: Sensor Characterization, NOAA Center for Operational Products and Services (internal document, available upon request).
- Park J. and R. Heitsenrether, Microwave Water Level Transition to Operations (MWWL TOP) WaterLog H-3611 Test Plan Part II: Sensor Response to Dynamic Water Levels, January 24 2013, NOAA Center for Operational Products and Services (internal document, available upon request).
- Park, J., R. Heitsenrether, and W. Sweet. 2014. Water level and wave height estimates at NOAA tide stations from acoustic and microwave sensors. *J. Atmos. Oceanic Technol.*, 31(10):2294–2308.
- Park, J., R. Heitsenrether, and W. Sweet. 2014. Water Level and Wave Height Estimates at NOAA Tide Stations from Acoustic and Microwave Sensors. U.S. Department of Commerce, NOAA Technical Report NOS CO-OPS 075.
http://www.tidesandcurrents.noaa.gov/publications/NOAA_Tech_075_Microwave_Water_Level_2014_Final.pdf
- Woodworth P.L. and D.E. Smith. 2003. A one year comparison of radar and bubbler tide gauges at Liverpool. *Int. Hydrogr. Rev.*, 4(3):42-49.

Testing and Use of Radar Water Level Sensors by the U.S. Geological Survey

Janice M. Fulford
U.S. Geological Survey, Hydrologic Instrumentation Facility,
Stennis Space Center, Mississippi 39529, USA

*Contact person: J.M. Fulford
E-mail: jfulford@usgs.gov*

○ Introduction

The United States Geological Survey uses water-level (or stage) measurements to compute streamflow at over 8000 stream gaging stations located throughout the United States (waterwatch.usgs.gov, 2016). Streamflow (or discharge) is computed at five minute to hourly intervals from a relationship between water level and discharge that is uniquely determined for each station. The discharges are posted hourly to WaterWatch (waterwatch.usgs.gov) and are used by water managers to issue flood warnings and manage water supply and by other users of water information to make decisions. The accuracy of the water-level measurement is vital to the accuracy of the computed discharge. Because of the importance of water-level measurements, USGS has an accuracy policy of 0.02 ft or 0.2 percent of reading (whichever is larger) (Sauer and Turnipseed, 2010). Older technologies, such as float and shaft-encoder systems, bubbler systems and submersible pressure sensors, provide the needed accuracy but often require extensive construction to install and are prone to malfunctioning and damage from floating debris and sediment. No stilling wells or orifice lines need to be constructed for radar installations. During the last decade testing by the USGS Hydrologic Instrumentation Facility (HIF) found that radar water-level sensors can provide the needed accuracy for water-level measurements and because the sensor can be easily attached to bridges, reduce the construction required for installation. Additionally, the non-contact sensing of water level minimizes or eliminates damage and fouling from floating debris and sediment. This article is a brief summary of the testing efforts by the USGS HIF and field experiences with models of radar water-level sensors in streamflow measurement applications. Any use of trade names in this article is for descriptive purposes only and does not imply endorsement by the U.S. Government.

○ Early Investigations of Radar Water-Level Sensors

In a search for better water level sensing technology, the USGS HIF tested in the late 1990s several models of frequency modulated continuous wave (fmcw) level sensors that were designed for tank level measurements. This early testing identified in the early 2000s a fmcw commercial tank-level radar by Texas Nuclear (acquired by Thermo Scientific) that used X-band frequency as being a good candidate for USGS water-level measurements

based on cost and accuracy. However, this unit did not provide native Serial Digital Interface at 1200 baud (SDI-12, 2013) communications that is used by data loggers installed in most USGS stations.

Additional testing was conducted on a version of the Texas Nuclear model that was offered by Design Analysis Associates (DAA) for the streamflow measurement market in 2003. The version included SDI-12 communications and it was sold as the H-360 (Design Analysis Associates, 2003). Temperature testing using a stationary target in a large environmental chamber found the H-360 model to have larger errors with decreasing temperature of about 0.03 ft over the tested temperature range of -40 to +20 C and to drop more measurements at the colder temperatures. This model was also tested at two field sites and compared with a float-encoder system at one site and with a bubbler system at the other site. Because older technologies usually measured water surfaces that were smoothed or low-pass filtered by the dimensions of either the stilling well and orifice or bubbler tubing and orifice, it was unclear how well radar water-level measurements would compare with the older technologies. Frequency analysis of the data found that the float-well system and to a lesser extent the bubbler system filtered out the higher frequency water level changes (periods less than 150 minutes) when compared to the radar sensor using its standard measurement settings. Summary statistics of the data found that the radar tended to measure a lower minimum water level, and may have a negative bias when surface waves are present. Results of the model tests are presented in "Radar water-level measurements for open channels" (Fulford and Davies, 2005a).

Simple estimates of the uncertainty of water-level measurements by radar, bubbler, and float-encoder systems were made to compare the relative accuracy of various types of water-level instruments. The uncertainty comparison based only on instrument specifications and the physics of the various sensor systems found that the H-360 model was more accurate than a bubbler system over a 30-ft range of stage. Field measurements made with bubbler and radar sensor were compared to periodic measurements with a wire-weight gage to confirm the simple uncertainty estimates. A wire weight gage is a reel with a weight hung on a cable that can be lowered to the water surface to make a water level measurement. Wire weight gages have a resolution of 0.01 ft (Sauer and Turnipseed, 2010). The radar compared more closely to the wire-weight gage readings over the 35 ft range of stage than did the bubbler system (Fulford and Davies,

2005b). The test results found that the H-360 model was close to meeting the needed accuracy and encouraged further investigations into other tank radar models.

○ Investigations of Tank Pulse Radars

In 2004 the HIF tested a tank level radar by Ohmart Vega that used pulse technology but did not have SDI-12 communications. The testing found that the model had better accuracy and less power consumption than the fmcw radars previously tested. However, the lack of SDI-12 communications limited the testing and application of the model at USGS measurement sites until two vendors offered pulse radars with SDI-12. The Ohmart Vega Puls 62 and the Design Analysis Associates H3611, equipped with SDI-12 communications, were made available in 2006. Both models were tested against a float-encoder system at the Salt River Project, Horse Mesa Dam in Arizona during a 35-ft drawdown of the reservoir. The H3611 compared well with the float-encoder system measurements and had no obvious trend with increasing air gap. However, the Puls 62 had a linear trend with air gap of 0.009 ft per ft that was likely due a correctable error in either the model firmware or calibration. No effects of waves or diurnal temperature cycling on the measurements were noticed in the collected data for either model. However, laboratory testing using a crude wave maker in a tank at the HIF Hydraulic Laboratory found that both sensors' default measurement settings resulted in under measurement of the water level at wave heights of 0.15 ft. Results of these tests are presented in "Accuracy of radar water-level measurements" (Fulford and others, 2007). Because of the good performance of the H3611 documented during HIF testing, several USGS Water Science Centers (WSC) opted to use the H3611 as a stage sensor at suitable sites.

Most WSC installed the H3611 on bridges, and were successful in operating the model. However, some WSC noted that the model would give erroneous stage measurements when spider webs and other insects were inside the horn antenna of the H3611. Simple horn covers that closed off the open end of the antenna were installed to eliminate the insects. Unfortunately, these simple covers frequently resulted in condensation collection inside the horn that caused erroneous measurements. In response to those problems manufacturers offered enclosed antenna models targeted for the streamflow measurement market, the Ott RLS and the DAA H3613. These enclosed antenna models eliminated most of the

problems from insects and based on HIF laboratory and field testing met USGS needs for stage measurement.

○ Field Experiences

Several radar sensors are being used that meet USGS OSW requirements and have reduced maintenance and installation efforts at many sites. However, site conditions and less than ideal installation locations can result in radar measurements that are not as good as those made with other types of sensors. And some locations will not be suitable for radar water-level sensors that are currently used by the USGS.

Proper location of the radar sensor is critical to good water-level measurements over the water-level range possible at a station. Radars should be located on a stable platform over a smooth water surface. The radar should be positioned so that large radar reflecting surfaces such as pier and beams are located outside of the beam angle of the radar. On a bridge, the radar sensor should be located near a pier or near to the end of a span, but far enough away that the radar beam angle doesn't impinge on the pier during low flow conditions.

When installing the radar, the range of valid water-level measurements for the sensor should be determined. The valid range of measurements can be used to help verify the data measured by the radar sensor. The maximum valid water level that the radar can measure at a site is equal to the current water-level reading plus the distance to the water surface measured by the radar minus the radar's blanking distance. The minimum valid water level that the radar can measure is equal to the distance measured with a weighted tape from the radar to the bottom of the channel underneath the radar sensor or to the previously measured water level at which no flow in the river or stream occurs (point of zero flow). If the point of zero flow is used, the radar will not measure changes in water level below the point of zero flow.

Some problems noticed at some streamflow stations using radar for water-level measurements are: small changes in water level occurring on a diurnal cycle, periodic jumps to a slightly lower reading for some period of time before returning to the slight higher reading, large jumps in stage, and noisy data during low or no flow conditions. Diurnal cycling of water level can result from excessive heating of the radar sensor housing and may be minimized by better ventilation or shading

of the sensor housing. Diurnal water level cycling can also result from thermal expansion of bridge spans or traffic loads deflecting the span and is most noticeable when the sensor is mounted too far from the supported end of the bridge span.

Infrequent or periodic jumps in water level reading of up to tenths of a foot can also occur and are suspected to be caused by wind driven waves. Measurements of wind at some sites show a correlation between wind and drops in measured water levels. This phenomenon has been noted at various locations by several field hydrographers throughout the USGS and it has been difficult to correct. Radars with a tighter beam angle may be somewhat less susceptible to this problem. Use of different sampling and filtering schemes for the radar measurements may have potential to reduce this problem.

Large jumps in measured water levels have occurred when the radar reflectivity of the water changes and an object in the beam angle then becomes the dominate radar reflecting object. Prior to ice cover forming over the water, a radar mounted close to a metal beam accurately measured the water level. However, after the ice cover formed and reduced the radar energy returned by the water surface, the bridge near the radar became the major reflector of radar energy and the source of an erroneous water-level measurement. Relocating the radar sensor so that the metal beam was outside the radar beam angle corrected this problem. Similarly, radar reflectivity can change during very low water levels and drying channel conditions. The exposure of bed sediment forms and the changing moisture of the bed sediments can result in noisy radar measurements when water levels are at or below the point of zero flow. Measurement of an appropriate point of zero flow and adjusting the location of the radar to ensure that at low water levels the radar is over water can help mitigate this problem.

○ Summary

Radar water level sensors provide several advantages over the older water level instruments. They require less effort to install than float-well, bubbler, or pressure sensor systems. Radar sensors require less maintenance than traditional water-level sensors because they are not in contact with the water. Because radar is a “non-contact” measurement method, it is not susceptible to being obstructed by sediment or debris and does not require that sediment be flushed from a stilling well. Radar water-level sensors may not work at all sites. However, testing and field experience has proven that radar water level sensors can be used at many sites to provide water-level measurements that have accuracy similar to or better than that of the older water-level instruments.

○ References

- Design Analysis Associates, Inc, 2003, Model H-360 Owner's Manual, Version 1.0, Logan, Utah, Design Analysis Associates, Inc., A-1p.
- Fulford, Janice M. and Davies, William J. 2005a, March “Radar Water-Level Measurement for Open Channels”, in Proceedings of Third International Conference on Irrigation and Drainage (USCID), San Diego, CA.
- Fulford, Janice M. and Davies, William J. 2005b, May “Radar Stage Uncertainty”, in Proceedings of EWRI/ASCE 2005 Conference, Anchorage, AK.
- Fulford, Janice M., Ester, Lee W., Heaton, John W. and Chandler, Howard, 2007, September, “Accuracy of radar water-level measurements”, in Proceedings of EWRI/ASCE 2007 Hydraulic Measurements and Experimental Methods Conference, Lake Placid, NY.
- Sauer, V.B. and Turnipseed, D.P., 2010, Stage measurement at gaging stations: U.S. Geological Survey Techniques and Methods book 3, chap. A7, 45 p. (Also available at <http://pubs.usgs.gov/tm/tm3-a7/>.)
- SDI-12 Support Group, (January 2013) SDI-12 A Serial-Digital Interface Standard for Microprocessor-Based Sensors, Version 1.3, accessed March 15, 2015, at <http://www.sdi-12.org/specification.php?fileID=1>
- U.S. Geological Survey, 2015, Waterwatch, accessed January 27, 2016, <http://waterwatch.usgs.gov/2014/summary/>



United Nations
Educational, Scientific and
Cultural Organization



Intergovernmental
Oceanographic
Commission

Intergovernmental Oceanographic Commission

United Nations Educational, Scientific and Cultural Organization
7, place de Fontenoy
75352 Paris 07 SP, France
Tel: +33 1 45 68 10 10
Fax: +33 1 45 68 58 12
Website: <http://ioc.unesco.org>