

# Microstructure Measurements around Deep Sea floor

-Direct Measurements of the Deep Sea Turbulence flow-





## Cross-ministerial Strategic Innovation Promotion Program

The Strategic Innovation Promotion Program (SIP) was launched by the Council for Science, Technology, and Innovation (CSTI), which oversees projects that target scientific and technological innovation in line with Japanese government directions as stated in the Comprehensive Strategy on Science Technology and Innovation and the Japan Revitalization Strategy. This interdisciplinary program among government agencies, academic institutes and private sectors addresses eleven issues. One of these issues is Next-Generation Technology for Ocean Resources Exploration.

### Zipangu in the Ocean Program and Protocols for Environmental Survey Technologies

Zipangu in the Ocean Program is a technical study of the development of submarine mineral deposits that takes into consideration the wise use of these resources.

One research area is the ecological survey of organisms and their long-term monitoring. However, an ecosystem consists of various interrelated factors; thus, in addition to a comprehensive understanding of the system, observation and analysis of each component to its most elemental level are unavoidable. Recently, increased environmental awareness and the necessity of forming a consensus have become key issues in conducting development activities. Growing concern for the environment by the public and the diversification of the use of maritime areas have complicated the interests of stakeholders. To facilitate the formation of a consensus under these conditions, it is important for standardized methods to be implemented. This will ensure that research processes are transparent and that the collection of survey data is objective.

This protocol series aims to introduce more accurate, user-friendly, objective and effective underlying technologies required to understand the environmental impact of submarine mineral resource development. We believe that creating such a technology tool-kit will allow us to develop these resources in a sustainable manner.

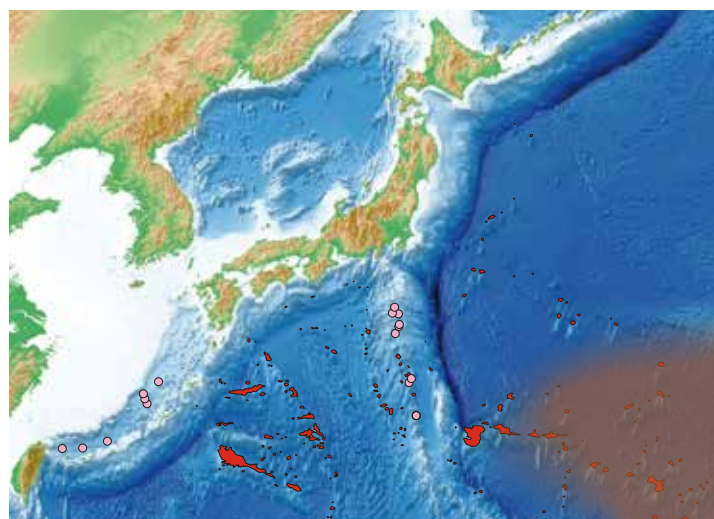

○ Thermal activity ● Cobalt-rich crust ● REY-rich mud ※1 based on Usui et.al(1994)

# Table of Contents

chapter 1	
Introduction.....	2
chapter 2	
Direct Deep Sea Turbulence Measurement Workflow.....	4
2-1 The Necessity of Direct Turbulence Measurements in Deep Seas	
2-2 Expendable Vertical Microstructure Profiler (VMP-X)	
2-3 Turbulence Measurement Workflow	
2-4 Turbulence Data Analysis and Processing	
2-5 Validation and Future Predictions of the Bottom Mixed Layer Dynamics	
chapter 3	
Setup 1 (Assembly).....	6
chapter 4	
Setup 2 (Testing).....	9
chapter 5	
Dispatch.....	13
chapter 6	
Recovery.....	17
chapter 7	
Deep Sea Turbulence Survey—Item Checklist—.....	18
chapter 8	
Maintenance (1): After Use.....	21
chapter 9	
Maintenance (2): Data Logger.....	2
chapter 10	
Maintenance (3): Rupture Disk Release.....	25
chapter 11	
Maintenance (4): Beacons.....	26
chapter 12	
Maintenance (5): General Maintenance for Voyages.....	27
[Attachment 1] Viewing the Setup File and Retrieving Data and Log File	
[Attachment 2] Viewing the Log File	
[Attachment 3] —VMP-X release logic sequence—	
[Attachment 4] Deployment Check List	
[Attachment 5] Maintenance Log Table (Ex.)	
[A p p e n d i x] VMP-X Assembly Drawings	



# Introduction



Hydrothermal fields are distributed over the deep sea floor, and contain abundant marine resources. Moreover, unique ecosystems are formed in the areas surrounding hydrothermal vents. The significant disturbance of deep-sea ecosystems and surrounding areas by drilling (stirring of suspended particulates and transport, diffusion, and re-deposition of muddy water) is a concern with respect to the exploration and development of marine resources<sup>1,2</sup> (Fig. 1).

The International Seabed Authority (ISA) compiled evaluation guidelines regarding the environmental impact of exploration activities of contracted explorers searching for polymetallic nodule (2001: ISBN/6/A/18, revised 2010: ISBN/16/LTC/7). The guidelines were revised in 2013 and now include activities associated with the exploration of polymetallic sulfides and cobalt-rich crust (ISBA/19/LTC/8). Regardless of the mineral species, the guidelines assume that the plumes generated by ore collectors (operational plume) and ore processing (discharged plume) and the re-deposition of the plumes seriously impact the deep-sea environment and ecosystem. It is imperative to accurately predict the re-deposition and diffusion areas to evaluate the negative effect of these plumes on the environment. In other words, the volume of suspended particulates generated by seabed exploration, drilling, and parallel and vertical diffusion in the seabed and bottom mixed layer and the volume of re-deposition in the deep-sea ecosystem must be evaluated quantitatively. There is also a need to predict the environmental impact on the deep seabed before and after exploration using numerical model simulation and environmental change data from affected sites and to develop mitigation plans accordingly.

The microstructure in the deep sea bottom, which dominates the dynamics of suspended particulates, needs to be identified first. However, flow environment measurements in the deep sea bottom to study the environmental impact on the marine resource development, such as for seabeds with hydrothermal fields, are rare. The authors measured the seabed current using an Acoustic Doppler Current Profiler (ADCP) to understand the flow environment with respect to the egg and larvae transport of species in the deep sea<sup>1,3</sup>. The observations satisfied the points of concern outlined in the aforementioned guidelines (Annex 10) for measuring the flow environment on bottom (place current meters as close to the bottom as possible; a distance of 1–3 m is recommended). However, current measurements are impractical in the case of the ADCP because the values obtained between the bottom and 4 m above the bottom become blank due to the characteristics of the instrument.

The dynamics (turbulence intensity) of the bottom mixed layer need to be understood to appropriately evaluate the environmental impact of the sedimentation and disturbance of suspended particulates in deep sea floor. In particular, understanding the dynamics of the bottom mixed layer between the bottom and a height of 60 m<sup>2,3</sup> is important, not only to understanding the re-deposition and disturbance of suspended particles but also the coalescence and dispersion of biological communities, behavior of hydrothermal circulation and hydrothermal plumes, and changes in biota and



biomass in chemosynthetic ecosystems. Direct turbulence measurements down to the bottom and analyses using numerical models<sup>2,4</sup> and past measurements, including current measurements with ADCPs and electromagnetic current meters and *in-situ* environmental measurements such as the vertical observation of water temperature and salinity with CTD, are required to understand the depth, range, and intensity of vertical mixing during the observations. Many studies focused on turbulence measurements (vertical mixing intensity) in coastal regions (basins and shallow sea areas)<sup>5-9</sup>. Recently, direct turbulence measurements in deep seas have been employed more frequently<sup>11</sup>.

With respect to microstructure measurements in deep-sea areas (measurements of the physical environment), this booklet focuses on direct turbulence measurements in deep seas. Note that *in-situ* measurements, analysis of existing data, and numerical models are combined in the protocol design to understand the microstructure in deep-sea areas (dynamics of the bottom mixed layer).

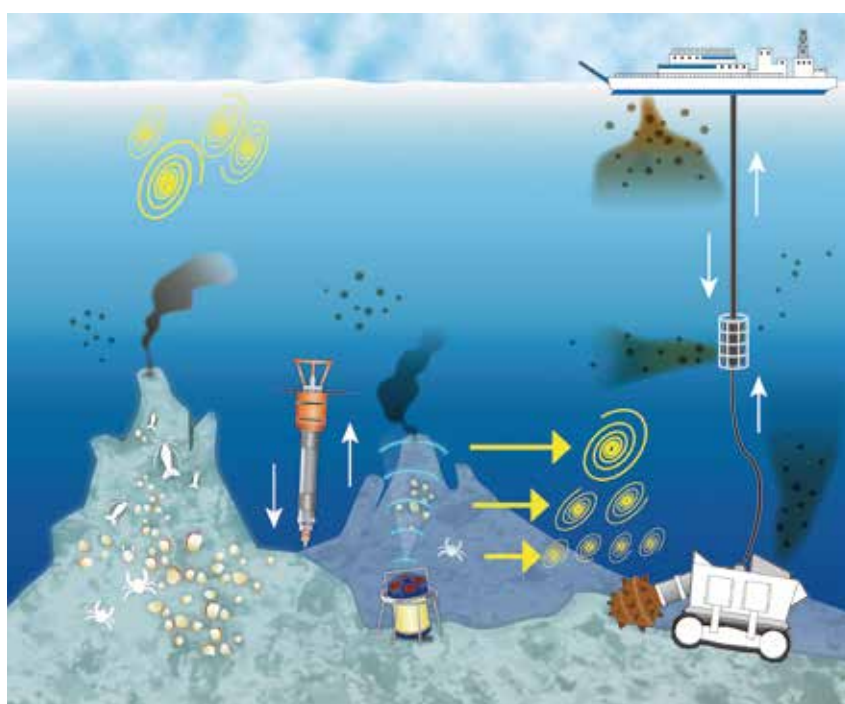

Fig. 1 Measurement of microstructure in the deep sea area.

## References

- 1) Furushima Y. and H. Yamamoto: Periodic behavior of deep sea current in the Hatoma Knoll Hydrothermal System. In: *Subseafloor Biosphere Linked to Hydrothermal Systems: TAIGA Concept*, Eds. J.-I. Ishibashi et al., Springer Japan, Tokyo, pp. 625–637, 2015.
- 2) Furuichi N., H. Higashi, and Y. Furushima: Towards the development of a dynamic model for suspended particulates in deep sea - LES experiment in current seabed boundary layer, *Aquabiology*, 38(2), pp. 145–150, 2016.
- 3) Furushima Y., N. Furuichi, H. Higashi, H. Koshikawa, and H. Yamamoto: Periodic behaviors of deep-ocean flow and turbulent mixing in hydrothermal field on the Okinawa Trough, Japan, *Proceedings of OCEANS 2016 MTS/IEEE Monterey*, ISBN DVD: 978-1-5090-1537-5, 2016.
- 4) Furuichi N. and H. Higashi: Fundamental analysis on particulate matter dynamics in bottom boundary layer by LES, *Journal of JSCE B2 (coastal engineering)*, 70: L1096–L1100, 2014.
- 5) Ito S: A study on the water mass and its changes in Oyashio and Kuroshio region and its relationship to the marine ecosystem, *Oceanography in Japan*, 21(2), pp. 33–50, 2012.
- 6) Saita T., S. Yano, A. Tai, S. Shiki, S. Shigeta, and T. Komatsu: *In-situ* measurements on vertical mixing in the Ariake Bay in winter, *Proceedings of Coastal Engineering*, 55, pp. 421–425, 2008.
- 7) Hashimoto E. and Y. Takasugi: Measurements of vertical mixing in the inner bay by floating MSP, *Proceedings of Coastal Engineering*, 45, pp. 966–970, 1998.
- 8) Nagao M., E. Hashimoto, and Y. Takasugi: Measurements of vertical mixing in Seto Inland Sea, *Proceedings of Coastal Engineering*, 51, pp. 946–950, 2004.
- 9) Nagao M., E. Hashimoto, Y. Takasugi, S. Chiba, and Y. Yamagata: Measurements of vertical mixing in Ago Bay, *Proceedings of Coastal Engineering*, 52, pp. 341–345, 2005.
- 10) Higashi H. and H. Maki: In situ measurements of vertical mixing and anoxic water mass in Tokyo Bay, *Journal of JSCE B2 (coastal engineering)*, 68(2), pp. L966–L970, 2012.
- 11) Hibiya T.: Challenges towards the mystery of the deep sea, *The University of Tokyo School of Science Department of Earth and Planetary Science web magazine*, Issue 3, (<http://www.eps.s.u-tokyo.ac.jp/webmagazine/wm003.html>)

# Direct Deep Sea Turbulence Measurement Workflow

## 2-1. The Necessity of Direct Turbulence Measurements in Deep Seas

It is well known that the re-deposition and stirring of suspended particulates during marine resource development can affect the surrounding ecosystems and environment. The basic flow environment needs to be understood to accurately assess the environmental impact. The development of the bottom mixed layer is an important environmental factor in understanding the re-deposition and stirring of suspended particles, dispersion of unique biological communities, hydrothermal circulation and hydrothermal plume. The depth, range, and intensity of the vertical mixing need to be identified through monitoring to determine the development of the bottom mixed layer. In other words, there is a need to directly measure the vertical microstructure of the turbulence with a turbulence profiler. Multiple turbulence measurements are required to guarantee the usefulness of the data because the temporal representativeness of single-shot data is very weak. A self-levitating profiler capable of measuring the turbulence from the bottom to the upper layers is needed to carry out multiple measurements.

This booklet includes detailed instructions on how to use the expendable vertical microstructure profiler (VMP-X; see cover photo) implemented by JAMSTEC in the end of 2015.

## 2-2. Expendable Vertical Microstructure Profiler (VMP-X)

The expendable vertical microstructure profiler (VMP-X, Fig. 2) consists of a data logger (VMP-X) and an expendable sensor (MicroXM). The device was developed by Rockland (Rockland Scientific International Inc.) in Canada; the expendable sensor component (MicroXM) was produced by JFE Advantech Co.,Ltd, in Japan.

The VMP-X is dropped off the ship and measures the current shear, water temperature, and pressure from the ocean surface layer to the bottom. After reaching the bottom, the VMP-X separates the sensors with a spindle (MicroXM) and starts floating back up. The device uses three types of separation mechanisms to float. The first separation mechanism involves the burn wire. The second mechanism uses a galvanic link for depths of 6,000 m or less; the third mechanism employs a rupture disk for depths of 6,000 m or more, which structurally ensures that the device will float upward. Once it floats up, an iridium beacon, radio beacon, and LED light will be activated at the sea surface and inform the user of its position. The device weighs 50 kg in the air and 5 kg in water. An optical fiber is used for data communication between the VMP-X and MicroXM. The MicroXM comprises two shear sensors, one water temperature sensor, and one pressure sensor.

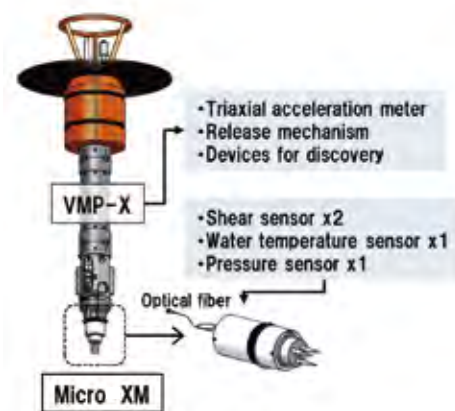

Fig. 2 Overview of the expendable vertical microstructure profiler. (VMP-X)

### 2-3. Turbulence Measurement Workflow

Fig. 3 shows the general turbulence measurement procedures using VMP-X. The turbulence data should be measured and recorded using VMP-X by conducting a turbulence survey following the procedures described in detail in Chapter III of this booklet.

The turbulence measurements should be planned such that multiple measurements are taken at a single location, although this might depend on the ship time. As discussed earlier, the temporal representativeness of single-shot turbulence measurement data is very weak. Therefore, multiple measurements are needed to guarantee the usefulness of the data. Be aware of tidal variations at the measurement location. Note the exact turbulence measurement time. The tidal details need to be taken into the account, for example, whether the tide was a spring or neap tide and flood or ebb when the device was dropped.

Current measurements using ADCP, vertical measurements of the water temperature and salinity with CTD or XCTD, and environmental measurements, such as the turbidity, should be conducted in addition to turbulence measurements.

### 2-4. Turbulence Data Analysis and Processing

The turbulence profiler data is processed using ODAS(turbulence analysis software). However, ODAS is based on MATLAB (m-file), which needs to be installed on the PC. If you are experienced in MATLAB, it is possible to make customizations by modifying the m-file.

Please see the “ODAS MATLAB Library Technical Manual Version 4.0” to learn how to use ODAS.

### 2-5. Validation and Future Predictions of the Bottom mixed Layer Dynamics

Understanding the dynamics of the bottom mixed layer is important to evaluate the impact of the sedimentation and stirring of suspended particulates during the marine resource development on the ecosystem and environment. The deep-sea turbulence needs to be measured directly. Fortunately, *in-situ* turbulence measurements in deep seas are used more frequently nowadays. However, the results of the turbulence measurements are merely a snapshot of the turbulence intensity in a given sea area. The turbulence changes over time. Therefore, data from multiple turbulence measurements need to be taken into account.

On the other hand, analysis tests using a numerical model are essential for validating and predicting the dynamics of the bottom mixed layer. The abundance of flow environment data is important to improve the accuracy of the numerical model. In other words, the design of an observation method (protocol) that integrates the *in-situ* measurements, analysis of existing data, and a numerical model is required to understand the microstructure of the flow in deep-sea areas (dynamics in the bottom mixed layer).



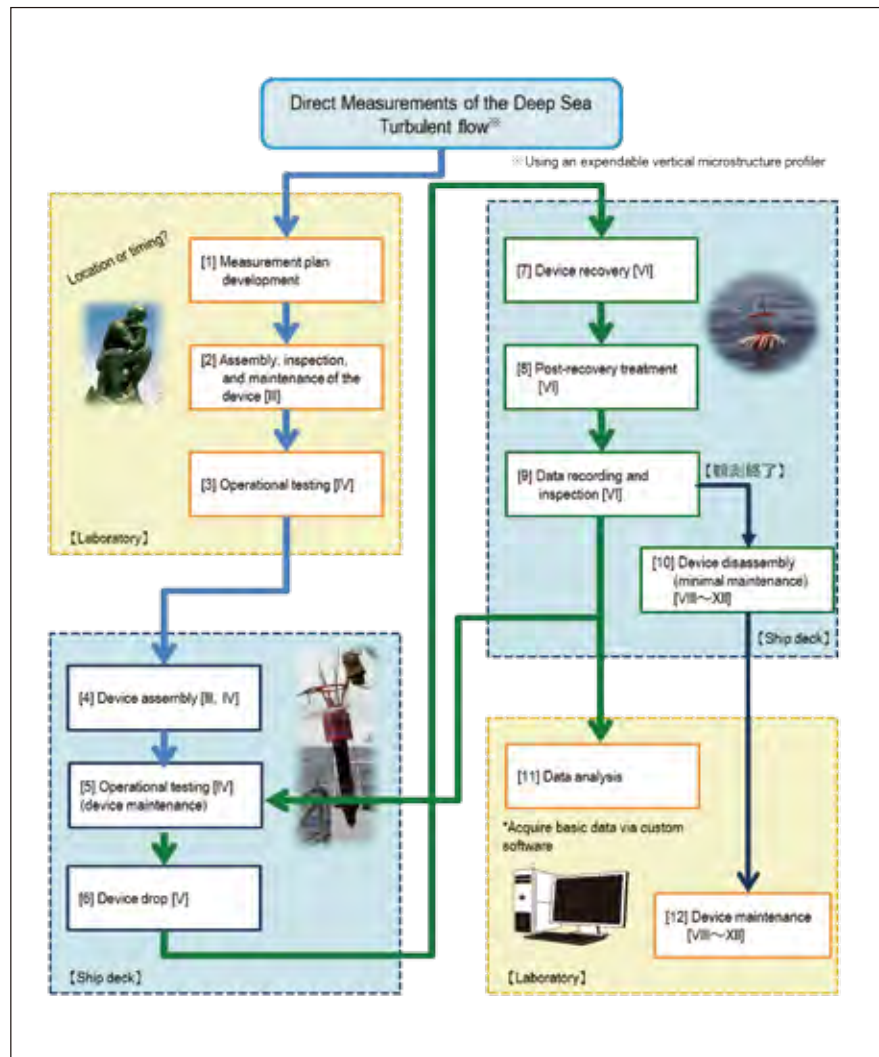







Fig. 3 Turbulence measurement workflow using expendable vertical microstructure profiler (VMP-X).

# chapter 3 Setup 1【Assembly】

No.	Detailed Steps	Check	Tools Used
1.	<ul style="list-style-type: none"> <li>•Ensure that the bolts and hose clamp of the float and main bodies of the VMP-X (component with data logger) are tightened.</li> <li>•Do not overtighten them.</li> <li>•Make sure that the data logger is sealed tightly.</li> <li>•Ensure that there is no gap in the bulkhead (lid).</li> </ul> 	<input type="checkbox"/> <input type="checkbox"/> <input type="checkbox"/> <input type="checkbox"/>	<ul style="list-style-type: none"> <li>■ Allen wrench [4 mm; bolt]</li> <li>■ Box wrench [8 mm; hose clamp] [10 mm; brush]</li> <li>■ Ratchet [11 mm; body] [13 mm; data logger]</li> </ul>



No.	Detailed Steps	Check	Tools Used
2.	<ul style="list-style-type: none"> <li>• Make sure that the hose clamp loosens freely.</li> <li>• Make sure that the hose clamp string (for fall prevention) is in the right position.</li> </ul> 	<input type="checkbox"/> <input type="checkbox"/>	
3.	<ul style="list-style-type: none"> <li>• Connect the float and main bodies (component with data logger) of the VMP-X. Align the orientation and fix the connection with bolts and a hose clamp. Do not overtighten them. This step is easier if the main body is raised vertically.</li> </ul> 	<input type="checkbox"/>	<ul style="list-style-type: none"> <li>■ Allen wrench [4 mm]</li> <li>■ Box wrench [8 mm]</li> </ul>
4.	<ul style="list-style-type: none"> <li>• Attach the communication and burn wire cables.</li> <li>• Attach a locking sleeve to each connector.</li> </ul> 	<input type="checkbox"/> <input type="checkbox"/>	
5.	<ul style="list-style-type: none"> <li>• Pull each cable out of the side hole of the front body (COMM/BURN) and attach the front body. Align the orientation again and fix the bodies using bolts and a hose clamp. Ensure that the bolts and hose clamp are tightened.</li> <li>• Ensure that the bolts and hose clamp are tightened</li> </ul> <p style="color: red;">※Do not overtighten them.</p> 	<input type="checkbox"/> <input type="checkbox"/>	<ul style="list-style-type: none"> <li>■ Allen wrench [4 mm]</li> <li>■ Box wrench [8 mm]</li> </ul>











## chapter 4

## Setup 2 [Testing]

No.	Detailed Steps	Check	Tools Used
1.	<ul style="list-style-type: none"> <li>•Connect the deck cable to the VMP-X connection cable.</li> </ul> 	<input type="checkbox"/>	<ul style="list-style-type: none"> <li>■Multimeter</li> </ul>
2.	<ul style="list-style-type: none"> <li>•Attach a banana jack to the deck cable box and measure the voltage of the battery with a multimeter (reference voltage: <b>14.8 V</b>, full battery <math>\geq</math> <b>16.7 V</b>). Charge the battery if the voltage is <math>&lt;</math> 14 V (full charge is recommended, even if the voltage is <math>&gt;</math> 14 V).</li> <li>※ Warning: The MicroXM is automatically separated if the voltage drops below 13 V!</li> </ul> 	<input type="checkbox"/>	<ul style="list-style-type: none"> <li>■Multimeter</li> </ul>
3.	<ul style="list-style-type: none"> <li>•Clean the tip of the optical fiber connector of the MicroXM with a cleaner.</li> <li>•Clean the optical fiber connector of the VMP-X data logger with a cleaner.</li> </ul> 	<input type="checkbox"/>  <input type="checkbox"/>	<ul style="list-style-type: none"> <li>■Optical fiber cleaner</li> <li>■Light</li> </ul>

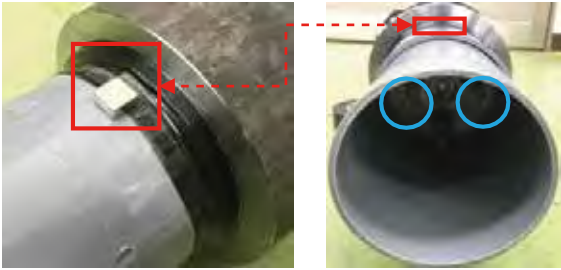
No.	Detailed Steps	Check	Tools Used
4.	<ul style="list-style-type: none"> <li>Loosely tie the MicroXM optical fiber connector and connect it to the VMP-X data logger.</li> </ul> <p>【Do not over-tighten the cap nut of the connector】            ※Be careful not to tie the knot too small            (a small knot causes communication errors).</p> <div style="display: flex; justify-content: space-around; align-items: center;"> <div style="border: 1px solid red; padding: 5px; width: 150px; text-align: center; color: red;">             The knot cannot be too small!           </div> <div style="border: 1px solid red; padding: 5px; width: 150px; text-align: center; color: red;">             The connector direction has to be correct. Insert the plug key (knob) into the groove of the receptacle.           </div> </div> <div style="display: flex; justify-content: space-around; align-items: center; margin-top: 10px;">   </div>	<input type="checkbox"/>	<ul style="list-style-type: none"> <li>■Light</li> </ul>
5.	<ul style="list-style-type: none"> <li>Ensure that the direction of the shear probe is appropriate.</li> <li>Ensure that the position of the engraving line on the shear probe and the dot on the flange are aligned.</li> </ul> <p>※ Rotate the axis and make adjustments if they are not aligned.</p> <p>※Rotating it will not be a problem up to <math>\pm 20^\circ</math>.</p> 	<input type="checkbox"/>  <input type="checkbox"/>	
6.	<ul style="list-style-type: none"> <li>Temporarily fix MicroXM to VMP-X. Attach a dummy burn wire and a galvanic link used for monitoring to the hose clamp; tighten enough, so that MicroXM does not fall off.</li> </ul> <p>※Be careful not to clamp the optical fiber.            ※Insert until the MicroXM stopper is in contact with the VMP-X.</p> 	<input type="checkbox"/>	<ul style="list-style-type: none"> <li>■Box wrench [8 mm]</li> </ul>
7.	<ul style="list-style-type: none"> <li>Connect Dsub 9 pin and USB from the deck cable box to the PC.</li> </ul> 	<input type="checkbox"/>	<ul style="list-style-type: none"> <li>■PC</li> </ul>

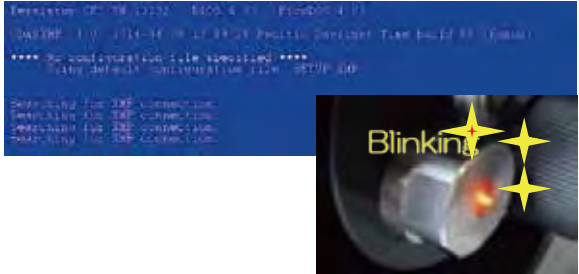

No.	Detailed Steps	Check	Tools Used
8.	<ul style="list-style-type: none"> <li>Temporarily fix MicroXM to the magnet. Attach the magnet on top of the sensor cover without removing the cover.</li> </ul> <p style="color: red; text-align: center;">Attach between the shear probes</p> 	<input type="checkbox"/>	<ul style="list-style-type: none"> <li>■ Plastic tape</li> </ul>
9.	<ul style="list-style-type: none"> <li>Start "Motocross" on the PC and turn on the deck cable box. Ensure that the LED light of the VMP-X is on.</li> </ul> 	<input type="checkbox"/>	
10.	<ul style="list-style-type: none"> <li>After turning on the cable box, the message "Searching for XMP connection..." will appear on the Motocross screen.</li> <li>If there is no connection problem between the VMP-X and MicroXM, a serial number will be displayed. Ensure that the number is correct.</li> <li>Ensure that the LED is blinking.</li> <li>Wait for 5 minutes.</li> </ul>  <p>※The following symptoms arise if there is a communication problem between the VMP-X and MicroXM.</p> <ol style="list-style-type: none"> <li>①The serial number is not displayed, it is displayed but the number is wrong, or it takes too long for it to be displayed (normally, the number is displayed after the fourth "Searching for XMP connection" message).</li> <li>②The message "Bad Buffer" is displayed within 5 minutes after the observation starts. In such cases, clean the tip of the optical fiber of the MicroXM and the optical fiber connector of the DLV-X with a cleaner. If the problem persists, replace the MicroXM with a new one.</li> </ol>	<input type="checkbox"/>  <input type="checkbox"/>  <input type="checkbox"/>  <input type="checkbox"/>	<ul style="list-style-type: none"> <li>■ Optical fiber cleaner</li> </ul>







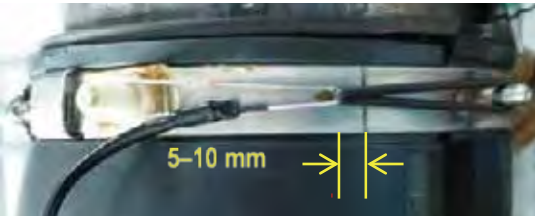

# chapter 5

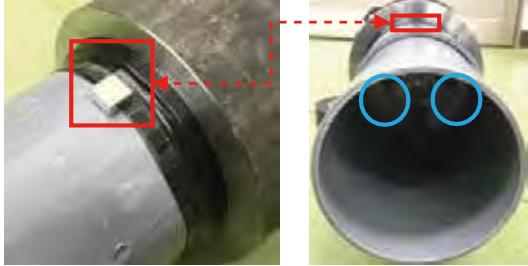



# Dispatch

No.	Detailed Steps	Check	Tools Used
1.	<ul style="list-style-type: none"> <li>•One hour prior to throwing the device into the water, test if the iridium beacon works properly.</li> <li>•After checking, wait with the power turned on.</li> <li>•Ensure that the radio beacon and flasher work properly before throwing in the device in the water and turn the power off after testing.</li> </ul> <p>※Mind the remaining battery power for both devices.</p>	<input type="checkbox"/>  <input type="checkbox"/>  <input type="checkbox"/>	<ul style="list-style-type: none"> <li>■Magnets</li> </ul>
2.	<ul style="list-style-type: none"> <li>•Exchange the dummy burn wire attached to the VMP-X with a real wire using a hose clamp.</li> </ul> <p>※Ensure that the burn wire does not have any scratches, neither on the O-ring nor the wire itself.</p> <p>※Do not use a used burn wire (the O-ring expands and its holding force declines when the wire is used).</p>	<input type="checkbox"/>	
3.	<ul style="list-style-type: none"> <li>•Tighten the hose clamp and fix the MicroXM.</li> <li>•Tighten the hose clamp until the edge of the O- ring of the burn wire exceeds the baseline of the hose clamp by 5 mm.</li> <li>•Shake the Micro-XM at this stage; if it slips, tighten the hose clamp more (the maximum baseline is 10 mm).</li> </ul> <p>※Ensure that the hose clamp does not hang out of or floats above the fix groove(it should be in contact with the groove over the entire perimeter).</p> 	<input type="checkbox"/> <input type="checkbox"/> <input type="checkbox"/>	<ul style="list-style-type: none"> <li>■Box wrench [8 mm]</li> </ul>
4.	<ul style="list-style-type: none"> <li>•If the depth is greater than 6,000 m, ensure that the rupture disk release is placed properly.</li> <li>•Ensure that the blade is positioned against the guard and fixed properly.</li> </ul> 	<input type="checkbox"/> <input type="checkbox"/>	<ul style="list-style-type: none"> <li>■Box wrench [8 mm]</li> </ul>

No.	Detailed Steps	Check	Tools Used
5.	<ul style="list-style-type: none"> <li>•Connect the deck cable to the VMP-X connection cable.</li> <li>•Connect the deck cable with the PC.</li> </ul> 	<input type="checkbox"/> <input type="checkbox"/>	
6.	<ul style="list-style-type: none"> <li>•Temporarily attach a magnet to the MicroXM. Attach the magnet on top of the sensor cover without removing the cover.</li> </ul> <p style="color: red; text-align: center;">Attach it between the shear probes</p> 	<input type="checkbox"/>	<ul style="list-style-type: none"> <li>■ Plastic tape</li> </ul>
7.	<ul style="list-style-type: none"> <li>•Start “Motocross” on the PC and turn on the deck cable box.</li> <li>•Ensure that the LED light inside the VMP-X turned on.</li> </ul> 	<input type="checkbox"/> <input type="checkbox"/>	

No.	Detailed Steps	Check	Tools Used
8.	<ul style="list-style-type: none"> <li>•After turning on the cable box, the message "Searching for XMP connection..."will appear on the Motocross screen. If there is no connection problem between the VMP-X and MicroXM, a serial number will be displayed; ensure that the number is correct.</li> <li>•Ensure that the LED is blinking.</li> <li>•Wait for 5 minutes.</li> </ul>  <p>If there is a communication problem between the VMP-X and MicroXM, the following symptoms will arise.</p> <ol style="list-style-type: none"> <li>①Serial number is not displayed, it is displayed wrong, or it takes a long time to be displayed (normally, the number is displayed after the message "Searching for XMP connection" is displayed for the fourth time).</li> <li>②The message "Bad Buffer" is displayed within 5 minutes after the observation starts.</li> </ol> <p>In such cases:      ※Clean the tip of the optical fiber of the MicroXM and optical connector of the DLV-X with a cleaner.      If the problem persists, replace the MicroXM with a new one.</p>	<input type="checkbox"/>   <input type="checkbox"/> <input type="checkbox"/>	
9.	<ul style="list-style-type: none"> <li>•If the message "Bad Buffer" is not displayed after 5 minutes, press the "q" button on the PC and stop the observation.</li> </ul>	<input type="checkbox"/>	
10.	<ul style="list-style-type: none"> <li>•Check the configurations of the depth trigger (pressure.txt) and time trigger (time.txt).</li> <li>•Type the following commands in the "Motocross" screen (see 2.12 for changes).            【View】Command: type            "type pressure.txt", "type time.txt"</li> <li>※If the configurations of the depth and time are erroneously set to be equal, format the CF card inside the VMP-X.</li> </ul>	<input type="checkbox"/> <input type="checkbox"/>	
11.	<ul style="list-style-type: none"> <li>•Turn off the deck cable box and remove the MicroXM magnet.</li> <li>•Remove the cables.            ※Do not forget to remove the magnet.</li> </ul>	<input type="checkbox"/> <input type="checkbox"/>	
12.	<ul style="list-style-type: none"> <li>•Connect the burn wire to the cable.</li> </ul> 	<input type="checkbox"/>	
13.	<ul style="list-style-type: none"> <li>•Move the VMP-X to the back of the deck.</li> </ul>	<input type="checkbox"/>	



No.	Detailed Steps	Check	Tools Used
14.	<ul style="list-style-type: none"> <li>•Attach the tested iridium beacon, radio beacon, and flasher to the VMP-X.</li> <li>•Fix the flag to the flasher.</li> </ul> <p>※ Keep the iridium beacon turned on.</p> 	<input type="checkbox"/> <input type="checkbox"/>	<ul style="list-style-type: none"> <li>■PC</li> </ul>
15.	<ul style="list-style-type: none"> <li>•Connect a short plug to the VMP-X and fix the locking sleeve.</li> <li>•Fix the short plug to the VMP-X body with a plastic tape.</li> <li>•After connecting the short plug, ensure that the LED light inside the VMP-X is turned on.</li> </ul> 	<input type="checkbox"/> <input type="checkbox"/> <input type="checkbox"/>	<ul style="list-style-type: none"> <li>■Plastic tape</li> </ul>
16.	<ul style="list-style-type: none"> <li>•Pour water over the MicroXM attachment of the VMP-X and ensure that it will not slip when shaking it.</li> </ul> 	<input type="checkbox"/>	<ul style="list-style-type: none"> <li>■Water</li> </ul>
17.	<ul style="list-style-type: none"> <li>•Move the VMP-X to the back end of the deck (or dropping site).</li> <li>•Wrap the dropping rope around the back ring of the VMP-X.</li> </ul> 	<input type="checkbox"/> <input type="checkbox"/>	<ul style="list-style-type: none"> <li>■Dropping rope</li> </ul>
18.	<ul style="list-style-type: none"> <li>•Turn on the radio beacon and flasher.</li> </ul>	<input type="checkbox"/>	<ul style="list-style-type: none"> <li>■Each Magnet</li> </ul>

No.	Detailed Steps	Check	Tools Used
19.	<ul style="list-style-type: none"> <li>•Remove the sensor cover and fix the magnet firmly with a plastic tape.</li> <li>•Ensure that the LED inside the VMP-X is blinking.</li> </ul> 	<input type="checkbox"/> <input type="checkbox"/>	<ul style="list-style-type: none"> <li>■ Magnet</li> <li>■ Plastic tape</li> </ul>
20.	<ul style="list-style-type: none"> <li>•Ensure that nothing is sticking out of the VMP-X (nothing that would get in the way of reaching the bottom).</li> </ul>	<input type="checkbox"/>	
21.	<ul style="list-style-type: none"> <li>•Throw it in!</li> <li>•Ensure that the MicroXM has not slipped until it lands in the water.</li> <li>※If it slips 5 mm or more, stop and recover the device.</li> <li>※The time trigger starts counting when the device starts to descend.</li> <li>※If you do not let it descend, the MicroXM will be automatically separated one hour after the monitoring starts.</li> </ul>	<input type="checkbox"/> <input type="checkbox"/>	

## chapter 6

# Recovery

No.	Detailed Steps	Check	Tools Used
1.	<ul style="list-style-type: none"> <li>•Hook the rear ring of the VMP-X floating in the sea and tow the device back onto the ship deck.</li> </ul>	<input type="checkbox"/>	<ul style="list-style-type: none"> <li>■ Recovery hook</li> </ul>
2.	<ul style="list-style-type: none"> <li>•Take the VMP-X to a designated location, rinse it with water, and wipe off the moisture (especially at the connector)</li> </ul>	<input type="checkbox"/>	<ul style="list-style-type: none"> <li>■ Water</li> </ul>
3.	<ul style="list-style-type: none"> <li>•Turn off the iridium beacon, radio beacon, and flasher.</li> </ul>	<input type="checkbox"/>	<ul style="list-style-type: none"> <li>■ Each Magnet</li> </ul>
4.	<ul style="list-style-type: none"> <li>•Remove the short plug connected to the VMP-X connection cable and check that the LED light inside the VMP-X is off.</li> </ul> 	<input type="checkbox"/>	
5.	<ul style="list-style-type: none"> <li>•Retrieve the data (log file, setup file).</li> <li>•See attachment 1 for instructions how to retrieve the data.</li> </ul>	<input type="checkbox"/> <input type="checkbox"/>	<ul style="list-style-type: none"> <li>■ PC</li> </ul>

# chapter 7



## Deep Sea Turbulence Survey

### —Item Checklist—

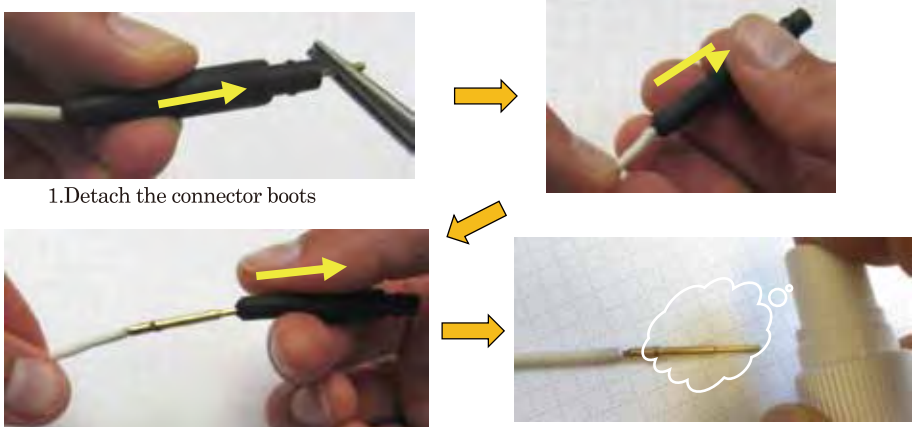

No.	Check		Category	Item	Quantity	In Charge	Note
	Start	Final					
1.			MicroXM	Micro-XM body	5		
2.			VMP-X	VMP-X body	1		
3.			VMP-X	MetOcean iridium beacon	1		MMI-7500
4.			VMP-X	MetOcean flasher	1		MMF-7500
5.			VMP-X	MetOcean radio beacon	1		MMB-7500ST
6.			VMP-X	Radio beacon receiver	1		KS-5551
7.			VMP-X	Radio beacon receiver antenna	1		
8.			VMP-X	Radio beacon receiver power source	1		
9.			VMP-X	Radio beacon receiver speake	1		
10.			VMP-X	Extra battery for MetOcean	100		CR123A
11.			VMP-X	Burn wire	5		Inside VMP-X box
12.			VMP-X	Galvanic link	5		Inside VMP-X box
13.			VMP-X	XMP stand	1		
14.			Tool	Tool set	1		
15.			Tool	Kimwipes	1		
16.			Tool	Kimwipes	1		
17.			Tool	Harnessing tape (electrical)	1		
18.			Tool	Plastic tape (mechanical)	3		
19.			Tool	Fiber cleaner	2		Inside VMP-X box
20.			Tool	Blow can	1		
21.			Tool	PC	1		Preinstalled software

# chapter 8

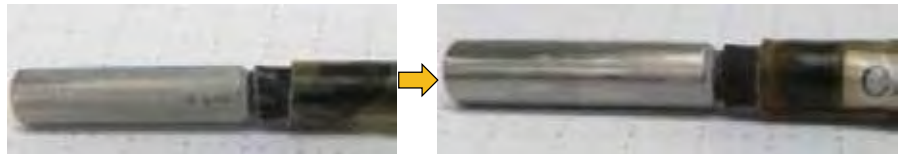
## Maintenance 1): After Use

No.	Detailed Steps	Check
1.	<ul style="list-style-type: none"> <li>•After recovering the VMP-X, attach a dummy plug to every cable and connector. ※The connector pin may short if it comes in contact with water, which will damage the instrument.</li> <li>•After recovering the VMP-X, fix the instrument to a designated stand and rinse off the seawater from the body with fresh water.</li> </ul>	<input type="checkbox"/>  <input type="checkbox"/>
2.	<ul style="list-style-type: none"> <li>•Dry the instrument. ※Thoroughly remove the moisture with an air duster.</li> <li>•Disassemble the VMP-X into three parts (front body, central body, and float).</li> <li>•Disassemble the VMP-X following the instruction manual 6.6 “Final Assembly” in reverse order.</li> </ul>	<input type="checkbox"/> <input type="checkbox"/> <input type="checkbox"/>
3.	<ul style="list-style-type: none"> <li>•Remove the connector boots from the used burn wire and store them for future usage.</li> </ul>  <p>1. Detach the connector boots</p> <p>2. Spray silicon onto the burn wire</p> 	<input type="checkbox"/>
4.	<ul style="list-style-type: none"> <li>•Remove white deposits from the cathode pin to ensure electric conductivity for the next cutting of the burn wire. ※White deposits: substance created by electrolysis during the cutting of the burn wire</li> </ul>  <p>Before maintenance (end of observation)      After maintenance</p>	<input type="checkbox"/>
5.	<ul style="list-style-type: none"> <li>•Inspect the connectors, bulkhead (lid for pressure-resistant case), and seal nut for corrosion and stains of the data logger. ※If an abnormality is confirmed on the surfaces, see the instruction manual 8.2 “Data Logger Maintenance” and take appropriate measures.</li> </ul>	<input type="checkbox"/>



No.	Detailed Steps	Check
6.	<ul style="list-style-type: none"> <li>•Rinse off the seawater (salt) from the cable with fresh water and let it dry.</li> <li>•Inspect the cable for damages and the pins for rusting.            ※If problems are detected, contact JFE Advantech (or RSI) to address them.</li> </ul>	<input type="checkbox"/> <input type="checkbox"/>
7.	<p>Inspect the release clamp (hose clamp) following the points below.</p> <ul style="list-style-type: none"> <li>•Inspect the polyethylene tape (UHMW tape) on the release clamp.            ※Replace the polyethylene tape if the tape is cut or if the surface beneath the tape looks like it might get damaged in the future.</li> <li>•Ensure that the mark (baseline) to appropriately extend the O-ring of the burn wire is visible.</li> <li>•Check if the groove edge of the stick for hooking the O-ring of the burn wire has sharpened.            ※Sand the edge with a fine sand cloth if it is sharp because it might otherwise cut the O-ring.</li> <li>•Inspect the release clamp for any corrosion. Replace the clamp if it is too weak for fixation.</li> <li>•If the release clamp is not circular, bend the band and restore the circular shape.</li> <li>•Ensure that the release clamp opens and closes smoothly.            ※Replace the release clamp if it does not open and close smoothly after restoring its circular shape.</li> </ul>  <p>★The role of the polyethylene tape (UHMW tape)</p> <p>Polyethylene tape is applied to prevent the burn wires and galvanic link from being in contact with the release clamp. If they come in contact, the release clamp corrodes faster due to galvanic action. Apply the tape to the attachment part of the burn wire and galvanic link when exchanging the polyethylene tape.</p>	<input type="checkbox"/> <input type="checkbox"/> <input type="checkbox"/> <input type="checkbox"/> <input type="checkbox"/> <input type="checkbox"/>
8.	<ul style="list-style-type: none"> <li>•Inspect the rubber-coupling hole on which the release clamp is fixed.            ※Exchange the coupling if the hole is ruptured, expanded, or if the release clamp cannot be tightened properly</li> </ul> 	<input type="checkbox"/>



# chapter 9



# Maintenance 2): Data Logger







We strongly recommend the maintenance (inspection) of the data logger in its entirety after the voyage (and if a long stretch of time has passed since the last use of the VMP-X).

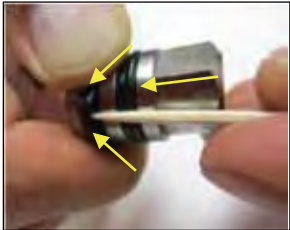
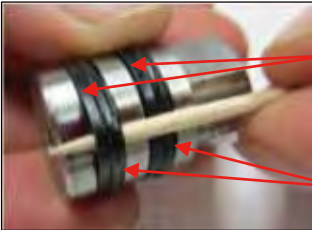

This is important to monitor the corrosion state and to ensure that the seal surface is intact and the data logger is maintained in a measurable state. Before disassembling the data logger, see [Reference Image 1] RSI Blueprint (Blueprint ID 010-062-07 Rev 2) and check its status.

No.	Detailed Steps	Check
1.	<ul style="list-style-type: none"> <li>•Ensure that a dummy plug is attached to the connector.</li> <li>•Rinse off the seawater (salt) from the data logger with fresh water and let it dry.</li> <li>•Detach the bulkhead (lid) on the back.</li> </ul> <p>■Tool used: 1/2”(13 mm) socket wrench, ratchet wrench</p> 	<input type="checkbox"/> <input type="checkbox"/> <input type="checkbox"/>
2.	<ul style="list-style-type: none"> <li>•A small brass tab is attached to the inside of the bulkhead on the back. The bulkhead is electrically connected to the zinc plate on the bulkhead.</li> <li>•Ensure that the protrusion on the brass tab is in contact with the base located in the inner diameter of the pressure case (silver ring that has not been processed with alumite).</li> </ul> 	<input type="checkbox"/> <input type="checkbox"/>
3.	<ul style="list-style-type: none"> <li>•Remove the flat-head bolt (1/4-20 × 0.5”) and zinc plate from the outside of the bulkhead (Figure 117)</li> </ul> <p>■Tool used: 5/32” (4 mm) Allen wrench, ratchet wrench (11 mm)</p>  <p>※The Galvanic anode has changed since the repair in April 2016. Remove with a ratchet wrench (11mm).</p>	<input type="checkbox"/>
	<ul style="list-style-type: none"> <li>•Rinse off the seawater (salt) and trash from the screw holes of the bulkhead (1/4-20”) with fresh water.</li> <li>•Do not leave water inside the screw holes.</li> </ul>	<input type="checkbox"/> <input type="checkbox"/>

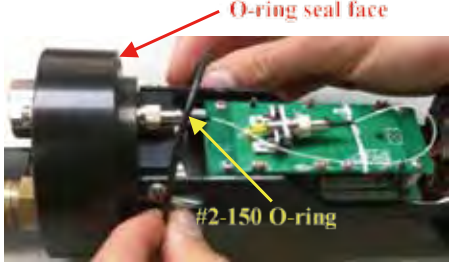
No.	Detailed Steps	Check
6.	<ul style="list-style-type: none"> <li>• Repeat steps 2–3 for the zinc plate on the front side of the bulkhead.</li> </ul>	<input type="checkbox"/>
	<ul style="list-style-type: none"> <li>• Wet a soft tissue that does not produce lint (cloth, kimwipes) with fresh water (or ethanol) and wipe all surfaces and seals.</li> <li>• Remove the remaining seawater (salt) and trash and dry the surface.</li> </ul> <div style="display: flex; justify-content: space-around; align-items: center;">   </div> <p style="text-align: center; margin-top: 5px;"> <span style="margin-right: 150px;">O-ring face</span> <span>1/4-20" hole</span> </p> <ul style="list-style-type: none"> <li>• Repeat step 5 with isopropyl alcohol and clean all seals of the bulkhead.</li> </ul>	<input type="checkbox"/> <input type="checkbox"/> <input type="checkbox"/>
6.	<ul style="list-style-type: none"> <li>• Ensure that there are no abrasions on the O-ring grooves of the bulkhead and seal nut.</li> <li>※ If there are abrasions, do not use the data logger because the instrument might get flooded.</li> <li>※ The component needs to be repaired or exchanged in this case; contact JFE Advantech (or RSD).</li> </ul>	<input type="checkbox"/>
7.	<ul style="list-style-type: none"> <li>• Use a toothpick to remove the O-ring (#2-014) and the backup ring (#8-014).</li> <li>• Be careful not to damage the O-ring groove.</li> <li>• Ensure that no holes were punched in the O-ring with the toothpick.</li> <li>• Pinch the O-ring and remove it from the groove.</li> </ul> <div style="display: flex; justify-content: space-around; align-items: center;">   </div> <p style="text-align: right; margin-top: 5px;"> <span>#8-014 Backup ring</span>   <span>#2-014 O-ring</span> </p>	<input type="checkbox"/> <input type="checkbox"/> <input type="checkbox"/> <input type="checkbox"/>
8.	<ul style="list-style-type: none"> <li>• Wet a soft tissue that does not produce lint (cloth, kimwipes) with fresh water (or ethanol) and wipe the O-ring and the backup rings of the sealing nut.</li> <li>• Remove the remaining seawater (salt) and trash and dry these surfaces.</li> <li>• Repeat the above-mentioned 2 steps using isopropyl alcohol and clean the O-ring and backup ring.</li> </ul>	<input type="checkbox"/> <input type="checkbox"/> <input type="checkbox"/>
9.	<ul style="list-style-type: none"> <li>• Ensure that the O-ring and backup ring of the seal nut have no scratches, distortions, or flattened surfaces.</li> <li>※ Exchange the parts if there the surfaces have defects. Regardless of their state, all O-rings <b>must be exchanged one year after use.</b></li> </ul>	<input type="checkbox"/>
10.	<ul style="list-style-type: none"> <li>• Ensure that no hair, dust, or tissue lint is found on the O-ring groove; remove them if detected.</li> </ul>	<input type="checkbox"/>

No.	Detailed Steps	Check
11.	<ul style="list-style-type: none"><li>•Thinly apply grease to the O-ring and attach it to the seal nut.</li><li>•Attach the O-ring to the high-pressure side of the ring groove (outside).</li><li>•Attach the backup ring to the low-pressure side of the O-ring groove (inside) and assemble the concave surface and the O-Ring.</li></ul> 	<input type="checkbox"/> <input type="checkbox"/> <input type="checkbox"/>
12.	<ul style="list-style-type: none"><li>•Detach the bulkhead and circuit board from the front side of the pressure-resistant case.</li><li>•Be careful not to damage the entrance of the pressure-resistant case (O-ring seal side)</li></ul>  <p>Pull the bulkhead and circuit board on the front side out of the pressure-resistant case.</p>  <p>Bulkhead and circuit board</p> <p><b>【Extra】</b> A lithium battery(CR123A)is attached to the power supply board. Exchange the battery at least once a year, although this might depend on the frequency of use. ※Exchange the battery if the data logger does not turn on, even if the charged battery voltage of VMP-X is above 14 V; the battery is dead. ※The time and date of the clock on the board computer need to be reconfigured after the battery exchange (see page 8 of the 「Software User Guide」).</p> 	<input type="checkbox"/> <input type="checkbox"/>
13.	<ul style="list-style-type: none"><li>•Remove the O-ring (#2-150) from the inner frame of the bulkhead on the front side of the data logger.</li><li>•Ensure that there are no scratches on the lead and circuit board.</li></ul> 	<input type="checkbox"/> <input type="checkbox"/>



No.	Detailed Steps	Check
14.	<ul style="list-style-type: none"> <li>•Wet a soft tissue that does not produce lint (cloth, kimwipes) with fresh water (or ethanol) and wipe the below-mentioned components.</li> <li>•Remove the remaining seawater (salt) and trash and dry these surfaces.</li> <li>•Repeat the above-mentioned two steps using isopropyl alcohol to clean the surfaces and let them dry.</li> </ul> <ul style="list-style-type: none"> <li>◎O-ring seal on the bulkhead (13)</li> <li>◎Both ends of the pressure-resistant case</li> <li>◎O-rings (#2-150”) on the front and back of the bulkhead</li> </ul> 	<input type="checkbox"/> <input type="checkbox"/> <input type="checkbox"/>
15.	<ul style="list-style-type: none"> <li>•Clean the tip of the optical fiber of the Micro-XM with a one-click cleaner.</li> <li>•If possible, clean the optical connector with isopropyl alcohol and dry it with an air duster (compressed air).</li> </ul>  <ul style="list-style-type: none"> <li>◆Do not touch the glass core inside the optical connector.</li> <li>◆Scratching the glass core might inhibit the optical signal reception of the data logger.</li> </ul> <ul style="list-style-type: none"> <li>•Inspect the optical connector screw for any damage.</li> <li>•Inspect the O-ring surface inside the optical connector for damages and dents by corrosion.</li> <li>•Inspect the connector surface for dents by corrosion.</li> </ul> <p>※Do not use the data logger if there are damages or corrosion because the instrument is likely to flood. Contact JFE Advantech (or RSD) for repair or exchange of the components.</p>	<input type="checkbox"/> <input type="checkbox"/>  <input type="checkbox"/> <input type="checkbox"/> <input type="checkbox"/>
16.	<ul style="list-style-type: none"> <li>•Inspect the O-ring of the bulkhead for scratches, distortions, or a flattened surface.</li> <li>※Exchange the parts if there the surface has defects. Regardless of their state, all O-rings <b>must be exchanged one year after use.</b></li> <li>•Ensure that no hair, dust, or tissue lint is found on the O-ring groove and remove them if they are found on the front and back of the bulkhead.</li> </ul>	<input type="checkbox"/> <input type="checkbox"/>
17.	<ul style="list-style-type: none"> <li>•Apply a thin layer of grease to the O-ring of the front and back of the bulkhead and both ends of the pressure-resistant case (O-ring seal face).</li> <li>•Attach the O-ring of the front and back of the bulkhead to respective grooves and thread the inner frame of the data logger through the pressure-resistant case.</li> <li>•Be careful not to damage the insertion aperture (seal face) of the pressure-resistant case.</li> <li>•Thread the back of the bulkhead to the male screw on the back of the inner frame and attach it so that the protrusion on the brass tab is in contact with the base (silver ring that has not been processed with alumite) on the inner diameter of the pressure case.</li> </ul>	<input type="checkbox"/> <input type="checkbox"/> <input type="checkbox"/> <input type="checkbox"/>

No.	Detailed Steps	Check
18.	<p>• Insert the seal nut into the central hole on the back bulkhead and tighten the seal nut until there is no gap between the pressure-resistant case and each bulkhead.</p> <p>■ Tool used: 1/2" (13 mm) socket wrench, ratchet wrench</p>  <p>◆ Be careful not to let the O-ring stick out of the seal nut upon tightening the seal nut. Flooding might occur if it sticks out.</p>	<input type="checkbox"/>

## chapter 10

# Maintenance

## 3): Rupture Disk Release

Disassemble, clean, and inspect the rupture disk with care after its use.

No.	Detailed Steps	Check
1.	• Follow the instructions in the instruction manual 6.5 "Assembling the Rupture Disk Release" in reverse order.	<input type="checkbox"/>
2.	• Rinse off the seawater (salt) and trash on the components with fresh water.	<input type="checkbox"/>
3.	• Wet a soft tissue that does not produce lint (cloth, kimwipes) with fresh water (or ethanol) and wipe all surfaces.	<input type="checkbox"/>
4.	• Repeat the above-mentioned two steps using isopropyl alcohol to clean the surfaces and let them dry.	<input type="checkbox"/>
5.	<p>• Inspect all seal surfaces. In particular, ensure that there are no scratches on the cylinder hole, O-ring groove on the piston, and surface that comes in contact with the rupture disk.</p> <p>※ If there are scratches on these surfaces, do not use the rupture disk release. Contact JFE Advantech (or RSD) because the component needs to be repaired or exchanged.</p>	<input type="checkbox"/>
6.	• Follow the instructions in the instruction manual 6.5 "Assembling the Rupture Disk Release" and reassemble the disk.	<input type="checkbox"/>





# chapter 11

## Maintenance 4): Beacons

To avoid the risk of flooding, open the beacon lids only to exchange the battery.



No.	Detailed Steps	Check
1.	•Remove the beacons from the VMP-X float and rinse off the seawater and trash with fresh water.	<input type="checkbox"/>
2.	•Remove the sensor head and bottom lid. •There is a clear plastic tube inside the pressure-resistant case that insulates the pressure-resistant case, batteries, and circuit board. <b>Do not remove the plastic tube from the pressure-resistant case.</b>	<input type="checkbox"/> <input type="checkbox"/>
3.	•Wet a soft tissue that does not produce lint (cloth, kimwipes) with fresh water (or ethanol) and wipe the O-ring, O-ring groove, and edges of the pressure-resistant case (O-ring contact surfaces).	<input type="checkbox"/>
4.	•Repeat step 3 with isopropyl alcohol and dry the cleaned surface.	<input type="checkbox"/>
5.	•Ensure that the O-ring groove and edges of the pressure-resistant case (O-ring contact surfaces) are not damaged. ※If these surfaces are damaged, do not use the beacons to avoid flooding. Contact JFE Advantech for repair and exchanges of the components.	<input type="checkbox"/>
6.	•Ensure that the O-ring has no damages, distortions, or flattened surface. ※Replace it if there are any defects. Regardless of their state, be sure to replace all O-rings one year after their use.	<input type="checkbox"/>
7.	• Ensure that there is no hair, lint, or dust on the O-ring or O-ring groove.	<input type="checkbox"/>
8.	•Apply a thin layer of grease to the O-ring and edges of the pressure-resistant case.	<input type="checkbox"/>
9.	•Attach the O-ring to the groove and reassemble the beacons. •Be careful not to damage the edges of the pressure-resistant case (O-ring contact surfaces).	<input type="checkbox"/> <input type="checkbox"/>
10.	•Replace the batteries either after every voyage or depending on the frequency of use. See the instruction manual for information about the battery consumption.  【Reference on Battery Consumption】 ■Radio beacon MMB-7500ST battery life: approximately 4 days (4°C) ■Iridium beacon MMI-7500 battery life: signals every day for a year after 1.5 years on the seabed ■Flasher MMF-7500 battery life: approximately 16 days under standard configuration (4°C)	<input type="checkbox"/>
11.	•See the instruction manual for more information on the beacons.	<input type="checkbox"/>

# chapter 12 Maintenance 5): General Maintenance for Voyages

No.	Detailed Steps	Check
1.	<ul style="list-style-type: none"> <li>Disassemble the VMP-X following the instruction manual 6 "Assembling the VMP-X", in reverse order.</li> <li>Line up your parts inside a container large enough to hold all parts to reduce the risk of wrong assembly.</li> </ul>	<input type="checkbox"/>  <input type="checkbox"/>
2.	<ul style="list-style-type: none"> <li>Rinse off the seawater (salt) and trash thoroughly with fresh water and dry the parts thoroughly.</li> </ul> 	<input type="checkbox"/>
3.	<ul style="list-style-type: none"> <li>Ensure that the plastic parts are not damaged and there are no problems with respect to the screw holes (whether heli-coil is sticking out or not).</li> </ul>	<input type="checkbox"/>
4.	<ul style="list-style-type: none"> <li>Ensure that the parts are not damaged or rusted.</li> <li>※If a component needs to be repaired or exchanged, contact JFE Advantech (or RSD).</li> </ul>	<input type="checkbox"/>
5.	<ul style="list-style-type: none"> <li>Ensure that there are no damages to the polyethylene tape (UHMW tape) underneath the hose clamps (float, rupture disk release, retaining ring, and beacon). Replace the polyethylene tape if it is damaged or its surface has scratches.</li> </ul>  <p>Reapply polyethylene tape (UHMW tape) to the hose clamp groove of the float.</p>	<input type="checkbox"/>
6.	<ul style="list-style-type: none"> <li>Apply an anti-seizure lubricant (Aqualube) to each bolt thread.</li> </ul>  <p>Applying an anti-seizure lubricant to the bolt threads (Aqualube).</p>	<input type="checkbox"/>
7.	<ul style="list-style-type: none"> <li>Reassemble the VMP-X for the next voyage.</li> <li>Test the VMP-X after assembly and store the device.</li> <li>[See instruction manual 6 "Assembling the VMP-X"]</li> </ul> 	<input type="checkbox"/>





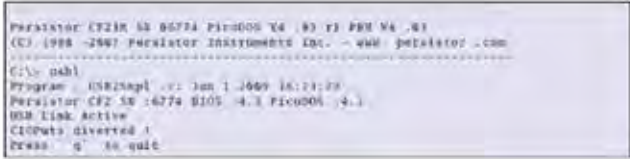



**【Attachment 1】 Viewing the Setup File and Retrieving Data and Log File**

No.	Detailed Steps	Check	Tools Used
1.	<p><b>【Common Procedures】</b></p> <ul style="list-style-type: none"> <li>•Connect the deck cable to the VMP-X connection cable.</li> <li>•Connect the deck cable and the PC.</li> </ul> 	<input type="checkbox"/> <input type="checkbox"/>	<p>■PC</p>
2.	<p><b>【Common Procedures】</b></p> <p>(1)Start “Motocross” on the PC and turn on the deck cable box.</p> <p>(2)Ensure that the LED inside the VMP-X turned on.</p>  <p>(3)After turning on the cable box, a continuous string of letters will appear on the “Motocross” screen.</p> <p>(4)After confirming, type command “q” and stop the display of letters.</p>  <p>(5)Type command “usb1” and start “RSILink”.</p> <p>(6)Press the 『Open USB Link』 button on the 『CF2 to PC』 screen and read in the data into the VMP-X.</p>	<input type="checkbox"/> <input type="checkbox"/> <input type="checkbox"/> <input type="checkbox"/> <input type="checkbox"/> <input type="checkbox"/>	

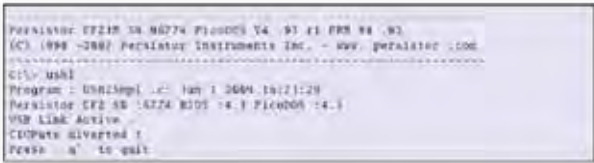

**【Attachment 2】 Viewing the Log File**

No.	Detailed Steps	Check	Tools Used
1.	<ul style="list-style-type: none"> <li>•Connect the deck cable to the VMP-X connection cable.</li> <li>•Connect the deck cable and the PC.</li> </ul> 	<input type="checkbox"/> <input type="checkbox"/>	<p>■PC</p>
2.	<p><b>【Common Procedures】</b></p> <p>(1)Start “Motocross” on the PC and turn on the deck cable box switch.</p> <p>(2)Ensure that the LED inside the VMP-X turned on.</p>  <p>(3)After turning on the cable box, a continuous string of letters of letters will appear on the “Motocross” screen.</p> <p>(4)After confirming, type command “q” and stop the display of letters.</p> 	<input type="checkbox"/> <input type="checkbox"/> <input type="checkbox"/> <input type="checkbox"/>	
3.	<p><b>【How to view the log file】</b></p> <p>Type the following commands into the Motocross screen.</p> <p>(1)Change the directory using the command “cd” (Change Directory)  <b>【View】</b> Command:del  “cd data”</p>  <p>-----</p> <p>(2)Display the log file  <b>【View】</b> Command: type  “type logfile.tx”</p>  <p>-----</p> <p>(3)Revert the directory to the original path after viewing the log file  <b>【View】</b> Command:del  “cd..” (two periods)</p> 		
4.	<ul style="list-style-type: none"> <li>•Type “q” in the “Motocross” screen and quit “Motocross”.</li> <li>•Turn off the deck cable box.</li> </ul>	<input type="checkbox"/> <input type="checkbox"/>	

## 【Attachment 3】—VMP-X release logic sequence—

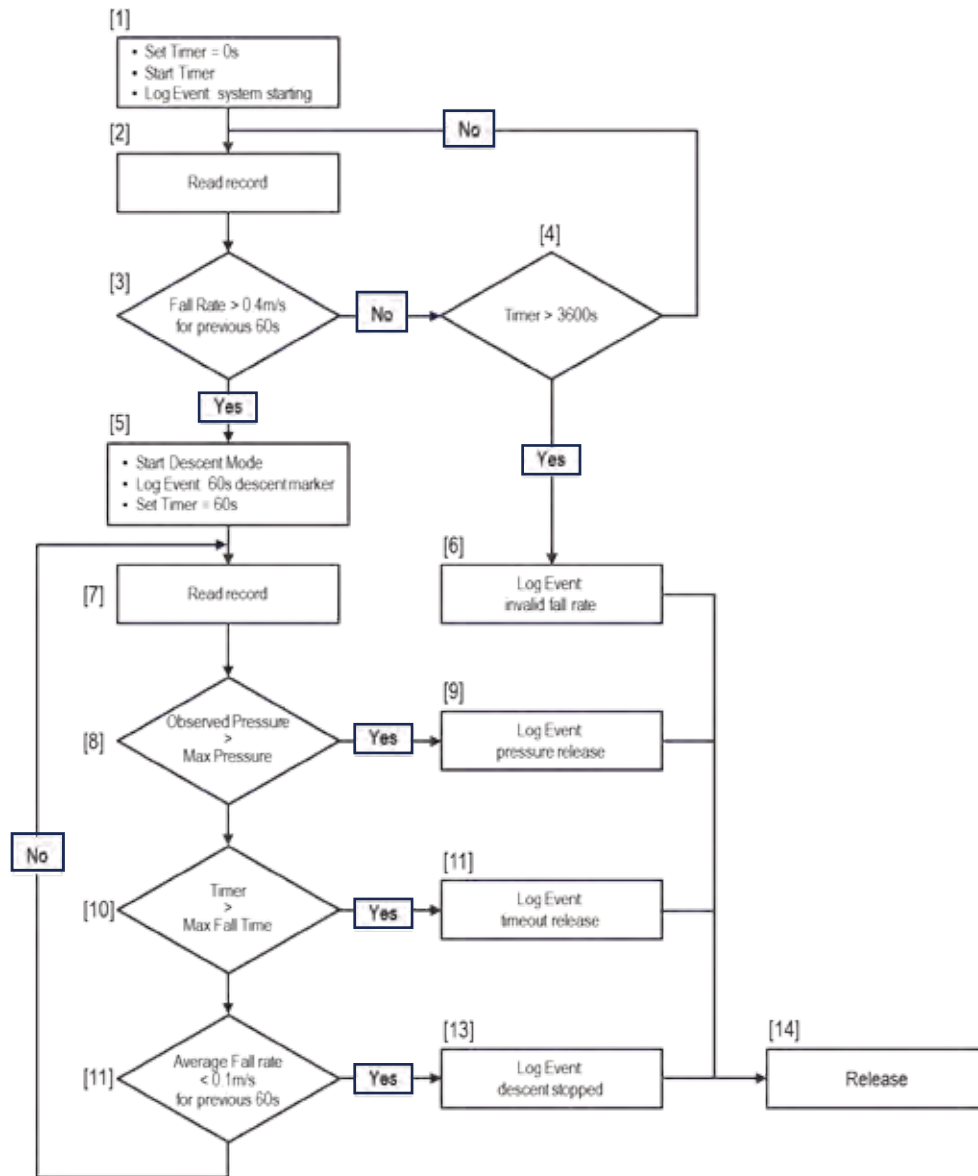

## 【Attachment 4】Deployment Check List

It is assumed that the VMP-X has been assembled per the Rockland Scientific International VMP-X User Manual and is ready to be deployed.

Once the preparation is complete, be sure to check the following before dropping the device.

## 【VMP-X】

- Ensure that all bolts and hose clamps are tightened. Make sure they are not too tight.
- Ensure that all instruments are firmly fixed (beacons, float, and spindle). Ensure that there are no loose spots.
- Ensure that the cable is fixed. Align the communication and burn wire cables neatly.
- Ensure that a locking sleeve is attached to all connectors.

## 【Data Logger】

- Ensure that the data logger is firmly sealed. Make sure that there are no gaps in the bulkhead (lid).
- Ensure that the cables are connected properly and that the air inside the connectors is removed.
- Ensure that a locking sleeve is attached to all connectors.

### **【Beacons】**

- Turn the power of all beacons on.
  - Test the communication of the radio beacon using a portable compass.
  - Test the communication of the iridium beacon using the iridium receiver.
  - Ensure that the flashers flash properly.
- 

### **【MicroXM】**

- Ensure that there is a knot in the optical fiber.
  - Ensure that the optical fiber connector is clean.
  - Ensure that the optical fiber connector is connected to the VMP-X.  
Make sure the optical fiber connector is not too tight.
  - Test the communication with the VMP-X. Verify that data files with a correct serial number are created. Check the calibration output and make sure that the sensors are functioning properly.
  - Ensure that the direction of the shear probe is appropriate.
- 

### **【Release】**

- Ensure that the hose clamp expands smoothly before attaching it.
  - Ensure that the galvanic link is firmly fixed.
  - Ensure that the release clamp string (fall prevention) is positioned correctly.
  - Ensure that the O-ring edges of the burn wires are within a 5–10-mm range from the baseline.
  - Ensure that the O-ring of the burn wire does not have scratches or cracks.
  - Ensure that the distance between the aluminum clamp of the burn wire and the exposed part is short.
  - Ensure that the burn wire is connected.
  - If the depth exceeds 6,000 m, ensure that the rupture disk release is positioned properly (including the position and fixation of the blade against the guard).
  - Ensure that the O-ring of the burn wire does not have scratches or cracks.
  - Ensure that the hose clamp does not hang out of or floats above the fixed groove (it should be in contact with the groove over the entire perimeter).  
Also, ensure that the Micro-XM does not slip off when twisting it.
- 

### **【Pre-Drop】**

- Ensure that the front parts of the VMP-X and float are wrapped.
- Ensure that nothing sticks out of the VMP-X (might prevent proper landing at the seabed).
- Activate the Micro-XM.
- Ensure that the magnet is firmly fixed.
- Activate the VMP-X and fix a locking sleeve at the junction between the dummy connector and extension cable.
- Ensure that the data logger LED is blinking (which denotes that data recording is in progress).
- Ensure that a release rope is firmly attached to the tail ring of the VMP-X.
- Ensure that the sensor cover pipe is removed from the Micro-XM.



## 【Attachment 5】Maintenance Log Table (Ex.)

## VMP-X Maintenance Log Table

No.	Data YYYY/ MM/DD	Description of Service	Remarks	Operator
1.	2016/ 10/31		KR16-15 (11/9-11/16) [purchase] O-ring	T.F. & H.I.
2.				
3.				
4.				
5.				
6.				

**【Appendix】 VMP-X Assembly Drawings**

a) 010-061-07 Rev 1 “Assembly, VMP-X”

Item NO.	Part Number	REV	Description	QTY
1	500-865-10	2	Rubber Coupling, VMP-X	1
2	013-099-20	0	Assembly, Front Hull, VMP-X	1
3	013-091-20	2	Assembly, Release Clamp, VMP-X	1
4	780-000-10	-	Galvanic Link, AAO.5, International Fishing Devices	1
5	013-088-20	2	Assembly, Burn Wire, VMP-X	1
6	013-096-20	1	Assembly, Rupture Disk Release, VMP-X	1
7	500-906-10	2	Rupture Disk Release Holder, VMP-X	1
8	500-866-10	1	Mounting Bracket, Rupture Disk Release, VMP-X	1
9	500-916-10	0	Liner, Rupture Disk Release, VMP-X	1
10	750-033-10	-	Reducing Bushing, ABS Pipe, 4 x 3 Pipe Size	1
11	500-930-10	0	Ballast, Front Hull, VMP-X	2
12	500-931-10	0	Ballast, Rupture Disk Release, VMP-X	1
13	013-095-20	1	Assembly, Middle Hull, VMP-X	1
14	010-062-20	2	Assembly, Data Logger, VMP-X	1
15	013-101-20	0	Assembly, Mounting Ring, Data Logger, VMP-X	2
16	500-855-10	1	Clamp Ring, Data Logger, VMP-X	2
17	014-056-20	2	Assembly, Welded, Recovery Ring, VMP-X	1
18	013-100-20	0	Assembly, Rear Hull, VMP-X	1
19	013-102-20	0	Assembly, Flotation Core Lower Retainer, VMP-X	1
20	013-103-20	0	Assembly, Flotation Core Upper Retainer, VMP-X	1
21	013-104-20	0	Assembly, Flotation Collar Half, VMP-X	2
22	565-020-10	2	Flotation, Core, 6000m, VMP-X	1
23	500-859-10	1	Foam, Open Cell, Lower Core, VMP-X	1
24	500-914-10	1	Foam, Open Cell, Upper Core, VMP-X	1
25	014-058-20	0	Assembly, Weldment, Brush, VMP-X	1
26	020-031-10	-	Flasher, 11000m rated, XMF-11K, Xeos	1
27	020-029-10	-	RF Beacon, 11000m, Xeos	1
28	020-028-10	-	Xeos, XMi-11K, Iridium Beacon	1
29	591-163-10	-	O-Ring, 2-237 Buna-N, 70A	2
30	630-250-10	-	Screw, Cap, 1/4-20 x 0.75, Socket Hd Flat, SS316	27
31	859-007-10	-	Hose Clamp, 1/2" band, 1-1/4 -- 2-1/4, 32-57mm dia, 300SS (SAE No. 28)	1
32	630-628-10	-	Screw, Cap, 1/4-20 x 1.5, Socket Button Head	4
33	634-009-10	-	Nut, Hex, 1/4-20, SS316	10
34	633-011-10	-	Washer, Flat, 1/4, Nylon	18
35	633-018-10	-	Washer, Lock, Split-Ring, 1/4, SS316	20
36	630-622-10	-	Screw, 1/4-20 x 0.5, Button Hd, Socket, 316SS	2
37	630-198-10	-	Screw, Mach, 10-32 x 1/2", Flat Hd, Slot Drive, 316SS	1

Item NO.	Part Number	REV	Description	QTY
38	634-003-10	-	Nut, Hex, #10-32, AISI316	2
39	859-022-10	-	Hose Clamp, 1/2" band, 5-3/4 -- 7-3/4, 146-197mm dia, 300SS (SAE No. 116)	3
40	630-512-10	-	Bolt, 1/4-20 x 1.25, SS316	8
41	640-180-10	-	18-8 SS Unthreaded Round Spacer 5/16" OD, 3/4" Length, #10	1
42	630-507-10	-	Screw, Cap, Socket, #10-32 x 2" long, 1-1/8" Thread, 316SS	1
43	859-033-10	-	Hose Clamp, 1/2" band, 11-3/4 -- 13-3/4, 298-349mm dia, 300SS (SAE No. 212)	2
44	859-008-10	-	Hose Clamp, 1/2" band, 1-1/2 -- 2-1/2, 38-64mm dia, 300SS (SAE No. 32)	3
45	630-511-10	-	Screw, 1/4-20 x 1.25, Flt Hd, HCS, SS316	6
46	750-037-10	-	Flag, Bicycle Safety	1

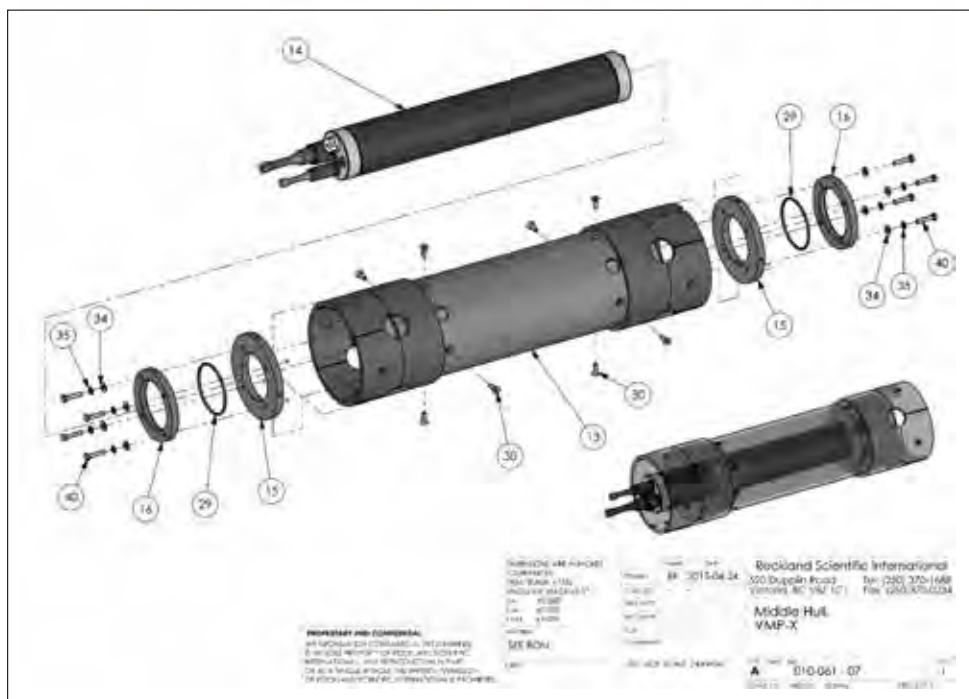
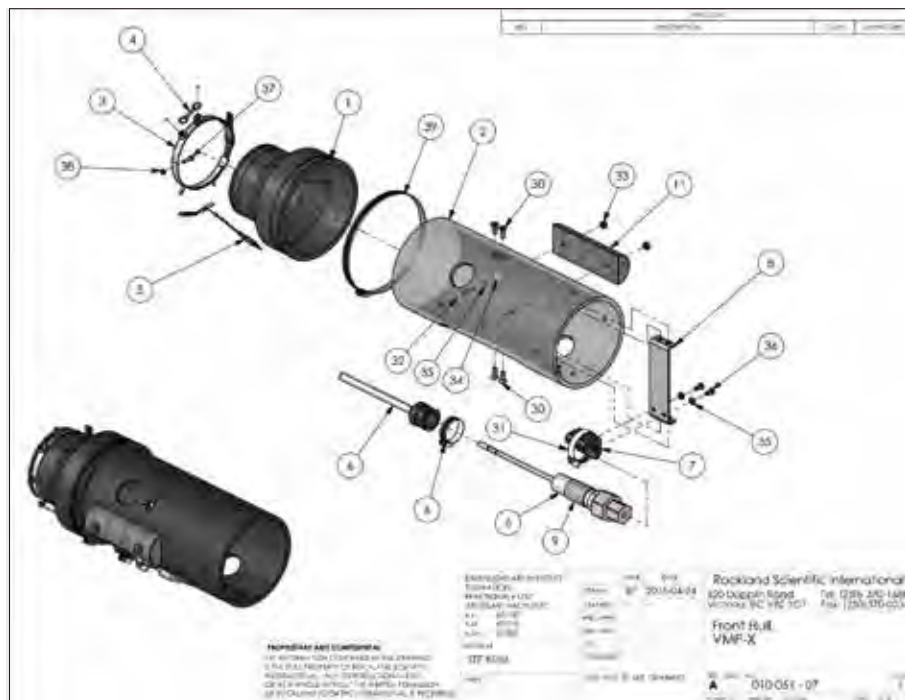

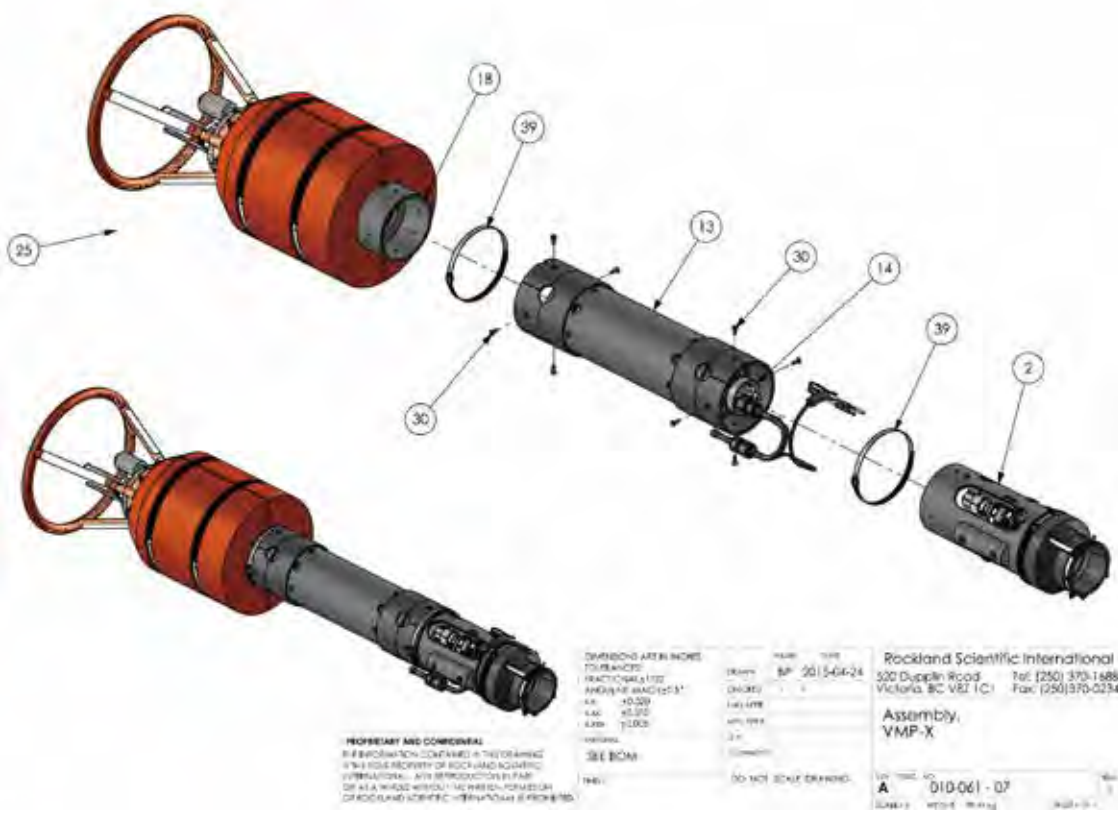
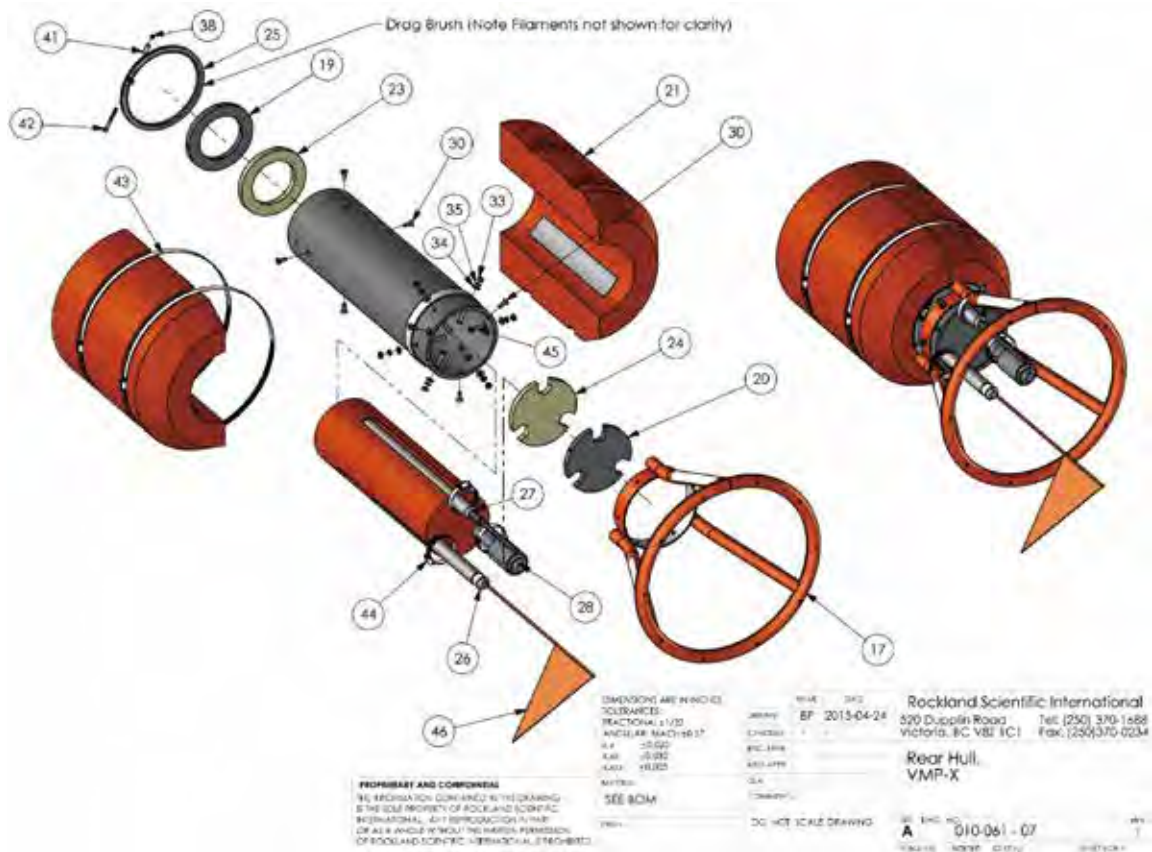

## b) 010-062-07 Rev 2” Assembly, Data Logger Unit, VMP-X”

Item No.	Part Number	REV	Description	QTY
1	500-850-10	3	Front Bulkhead, Data Logger, VMP-X	1
2	500-851-10	2	Rear Bulkhead, Data Logger, VMP-X	1
3	500-852-10	2	Pressure Tube, Data Logger, VMP-X	1
4	500-853-10	1	Frame Mounting Block, Data Logger, VMP-X	1
5	500-854-10	2	Internal Frame, Data Logger, VMP-X	1
6	500-385-10	0	Yoke Bracket, micro-Rider 6000-6	1
7	500-386-10	2	Sealing Nut, micro-Rider 6000-6	1
8	500-389-10	2	Anode, 0.72inch OD x .15, for 1/4 mount	2
9	500-419-10	0	Pressure Tube Contact Wiper	1
10	013-092-20	1	Assembly, LED, Data Logger, VMP-X	1
11	185-004-10	-	Battery, 14.8V, 1800mAh, polymer Li-Ion with PCB	1
12	185-002-10	-	Battery, Lithium, CR123A	1
13	880-009-10	-	Patch Cord, Optical, FC-FC, SM Simplex 9um	1
14	750-025-10	-	Foam, Adhesive-Back, 1/2 inch thick, 1 inch width	2
15	750-025-10	-	Foam, Adhesive-Back, 1/2 inch thick, 1 inch width	1
16	750-026-10	-	Hook & Loop, Adhesive Back, 2 inch width, Black	1
17	750-034-10	-	Cable Tie, Hook and Loop, 1/2 inch width, Black	2
18	651-016-10	-	Cable Tie Block .75 x .75, #6 Screw Mounting Hole	2
19	P031	2	Assembly, PCB, Solenoid Release	1
20	P046	3	Assembly, PCB, Optical Receiver, XMP	1
21	P040	1	Assembly, PCB, Persistor CF-2 Interface	1
22	P050	2	Assembly, PCB, Power-LP	1
23	023-005-10	-	CF Card, 4GB	1
24	640-112-10	-	Standoff, M/F, 4-40 x .50, Zinc Plated Brass	10
25	640-110-10	-	Standoff, M/F, 4-40 x .25, Zinc Plated Brass	5
26	640-113-10	-	Standoff, M/F, 4-40 x .625, Zinc Plated Brass	4
27	631-008-10	-	Screw, Pan Head, Phillips, #4-40 x 0.25 Lg, 304SS	12
28	630-616-10	-	Screw, Cap, Button HD, 10-32x3/8, SS304	8
29	630-248-10	-	Screw, Cap, Hex Head, 1/40-20 x 1/2, SS316	2
30	630-257-10	-	Screw, Cap, Hex Head, 1/40-20 x 2, Full Thread, SS316	1
31	630-392-10	-	Screw, Cap, 10-32 x 3/4, Socket Head, SS316	4
32	633-018-10	-	Washer, Lock, Split-Ring, 1/4, SS316	2
33	633-011-10	-	Washer, Flat, 1/4, Nylon	2
34	634-009-10	-	Nut, Hex, 1/4-20, SS316	1
35	536-005-20	0	Kit, Wiring Harness, VMP-X	1
36	591-013-10	-	O-Ring, 2-014 Buna-N, 70A	3
37	591-014-10	-	O-Ring, 2-015 Buna-N, 70A	2
38	591-098-10	-	O-Ring, 2-150 Buna-N, 70A	2
39	592-013-10	-	Backup Ring, 8-014 Buna-N, 90A	2



Item No.	Part Number	REV	Description	QTY
40	591-354-10	-	O-Ring, Custom, Xyfluor, Lancer #501-0026	1
41	875-065-10	1	Cable, Underwater, Comms, Extender, VMP-X	1
42	875-066-10	1	ON Switch, Data Logger, VMP-X	1
43	875-072-10	1	Cable, UW, Burn Wire, VMP-X	1
44	550-065-10	-	Impulse MCBH-10-MP bulkhead	1
45	550-069-10	-	Impulse, Locking Sleeve, DLSA-F	1
46	550-070-10	-	Impulse, Locking Sleeve, DLSA-M	1
47	550-081-10	-	Impulse MCBH(WB)-2-FS bulkhead	1
48	550-079-10	-	Dummy Plug MCDL-2-FS	1
49	550-080-10	-	Dummy Plug MCDL-2-MP	1
50	550-067-10	-	Dummy Plug MCDL-10-MP	1
51	550-068-10	-	Dummy Plug MCDL-10-FS	1
52	550-083-10	-	Impulse, Locking Sleeve, MCDL-F	1
53	550-074-10	-	Impulse, RMA-MPD-HP	1
54	013-097-20	1	Assembly, Cathode, Burn Wire, VMP-X	1
55	880-008-10	-	Lancer, 500-BFC-S1-B01-000, FC-DRY HP Feedthrough, Long, 10kpsi	1
56	880-009-10	-	500-DFC-S0-N01-000; FC-DRY HP Dust Cap	1
57	871-006-20	0	Cable, Deck, VMP-X	1
58	871-007-20	0	Cable, Charging, 14.8V Li-Ion Battery	1
59	871-008-20	0	Cable, Alligator Clip	1

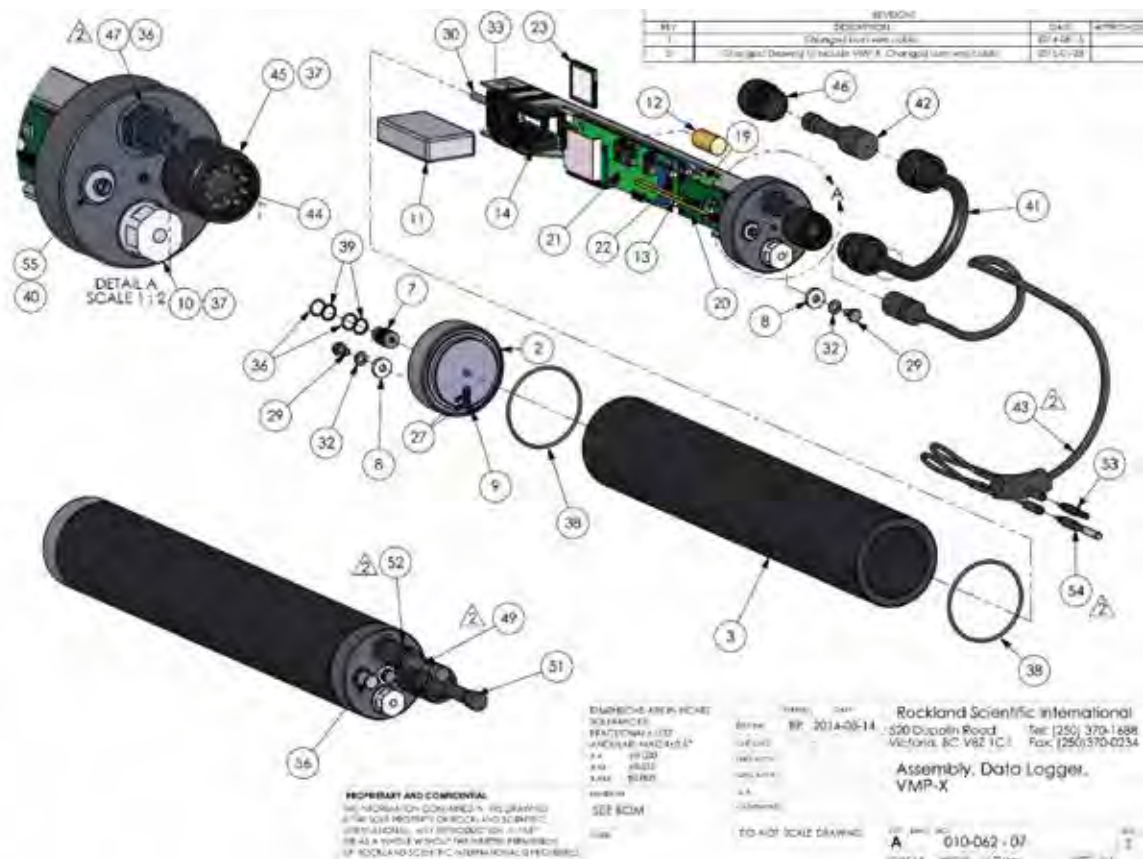

c) 013-096-07 Rev 1 "Assembly, Rupture Disk Release"

Item No.	Part Number	REV	Description	QTY
1	500-898-10	1	Cylinder, Rupture Disk Release, VMP-X	1
2	500-899-10	1	Piston, Rupture Disk Release, VMP-X	1
3	500-900-10	1	Base, Rupture Disk Release, VMP-X	1
4	500-901-10	3	Cap, Rupture Disk Release, VMP-X	1
5	500-902-10	4	Shaft, Rupture Disk Release, VMP-X	1
6	500-907-10	1	Mounting Collar, Blade Guard, Rupture Disk Release, VMP-X	1
7	500-908-10	2	Guard, Rupture Disk Release, VMP-X	1
8	591-016-10	-	O-Ring, 2-017 Buna-N, 70A	2
9	591-017-10	-	O-Ring, 2-018 Buna-N, 70A	2
10	591-022-10	-	O-Ring, 2-023 Buna-N, 70A	1
11	592-016-10	-	Backup Ring, 8-017 Buna-N, 90A	2
12	592-017-10	-	Backup Ring, 8-018 Buna-N, 90A	2
13	770-000-10	-	Rupture Disc, PB, 1/4" Diameter, AISI316, ZOOK	1
14	859-005-10	-	Hose Clamp, 1/2" band, 3/4 -- 1-3/4, 19-44mm dia, 304SS (SAE No. 20)	1
15	964-008-10	-	X-Acto Sleeve for #1 Light-Duty Knife	1
16	964-008-10	-	X-Acto Collet for #1 Light-Duty Knife	1
17	964-009-10	-	X-Acto Blade #17, Chisel, for #1 Light-Duty Knife	1

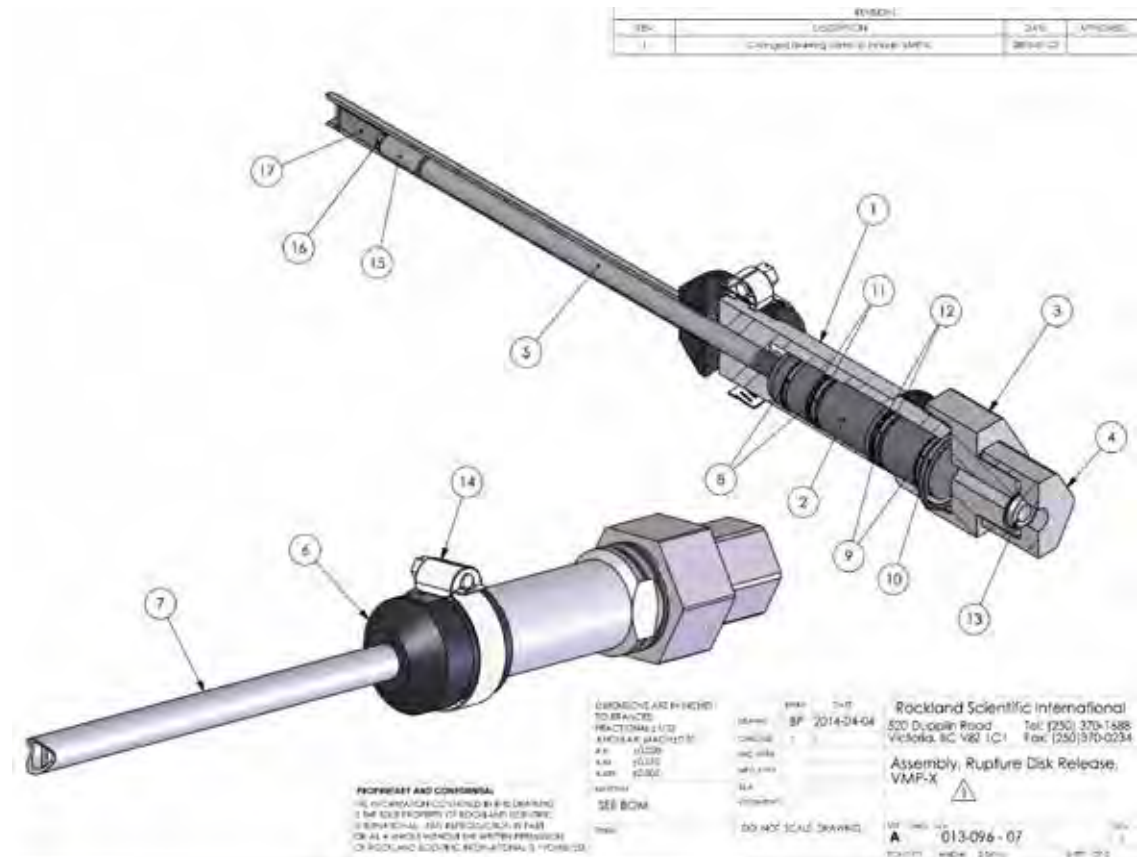



# SIP Protocol Series

## SIP Protocol No.1

Application of environmental metagenomic analyses for environmental impact assessments

## SIP Protocol No.2

Genetic Connectivity Survey Manuals

## SIP Protocol No.3

A rapid method to analyze meiofaunal assemblages using an Imaging Flow Cytometer

## SIP Protocol No.4

Acquisition of Long-Term Monitoring Images Near the Deep Seafloor by Edokko Mark I

## SIP Protocol No.5

Microstructure Measurements around Deep Sea floor  
-Direct Measurements of the Deep Sea Turbulence flow-

### Contact

JAMSTEC (Japan Agency for Marine-Earth Science and Technology)  
2-15, Natsushima-cho, Yokosuka-city, Kanagawa, 237-0061, Japan

**TEL** +81-46-866-3811

**FAX** +81-46-867-9755

**E-mail** sip-pc@jamstec.go.jp

