



| | |
|---|---|
| Joint European Research Infrastructure network for Coastal Observatory - Novel European eXpertise for coastal observaTories - JERICO-NEXT | |
| Deliverable title | Report on the status of HF-radar systems and cabled coastal observatories |
| Work Package Title | WP2 - Harmonization of technologies and methodologies - technical strategy |
| Deliverable number | D2.1 |
| Description | Report on the status of HF-radar systems and cabled coastal observatories |
| Lead beneficiary | AZTI |
| Lead Authors | Julien Mader (AZTI), Jochen Horstmann (HZG), Joaquin del Rio (UPC), Rajesh Nair (OGS) |
| Contributors | Anna Rubio (AZTI), Lorenzo Corgnati (ISMAR-CNR), Carlo Mantovani (ISMAR-CNR), Céline Quentin (MIO), Emma Reyes (SOCIB), Matias Carandell (UPC), Laurent Delauney (IFREMER), Jean François Rolin (IFREMER), Lauri Laakso (FMI) |
| Submitted by | Rajesh Nair (OGS), Wilhelm Petersen (HZG) |
| Revision number | 2.0 |
| Revision Date | 24/11/16 |
| Security | Consortium Only |





| History | | | |
|-----------------|-------------|-------------------------------------|---------------------------------|
| Revision | Date | Modification | Author |
| 1 | 11/10/2016 | Revision of first draft of document | Julien Mader Joaquin del Rio |
| 2 | 24/11/2016 | Revision of first draft of document | Rajesh Nair |
| | | | |
| | | | |
| | | | |
| | | | |

| Approvals | | | | |
|--------------------|------------------|---------------------|-------------|-------------|
| | Name | Organisation | Date | Visa |
| Coordinator | Patrick FARCY | Ifremer | 01/12/2016 | PF |
| WP Leaders | Rajesh Nair | OGS | 01/12/2016 | RN |
| | Wilhelm Petersen | HZG | 01/12/2016 | WP |

PROPRIETARY RIGHTS STATEMENT

THIS DOCUMENT CONTAINS INFORMATION, WHICH IS PROPRIETARY TO THE **JERICO-NEXT** CONSORTIUM. NEITHER THIS DOCUMENT NOR THE INFORMATION CONTAINED HEREIN SHALL BE USED, DUPLICATED OR COMMUNICATED EXCEPT WITH THE PRIOR WRITTEN CONSENT OF THE **JERICO-NEXT** COORDINATOR.





Table of contents

| | |
|--|----|
| 1. Executive Summary..... | 4 |
| 2. Introduction..... | 5 |
| 3. HF-Radars..... | 7 |
| 3.1 Introduction to HF-radar..... | 8 |
| 3.2 Phased array and direction finding systems | 9 |
| 3.3 Applications | 10 |
| 3.4 Planning and installation phase | 12 |
| 3.5 Main Operational Issues | 13 |
| 3.6 Quality Assessment..... | 15 |
| 3.7 Data Management | 18 |
| 3.8 References | 21 |
| 4. Cabled Observatories..... | 23 |
| 4.1 Issues during the installation phase..... | 23 |
| 4.2 Main operational issues | 36 |
| 4.3 Site maintenance | 45 |
| 4.4 Quality assessment | 49 |
| 4.5 Data management | 51 |
| 4.6 Applications | 54 |
| 4.7 Biofouling | 56 |
| 5. Conclusions..... | 57 |





1. Executive Summary

The JERICO network is constantly working to improve its core functionality, which is the ability to provide comprehensive observations of Europe's coastal seas and oceans. This means integrating new, promising observing technologies that can expand its spatial reach. While building the JERICO-NEXT project, HF-radar systems and cabled coastal observatories were identified as particularly attractive choices from this point of view, and a distinct task, Task 2.3 in Work Package 2 (WP2), was designed to facilitate their assimilation into the network's established observing system.

High Frequency radar (HF-radar) technology offers the means to gather information on surface currents and sea state over wide areas with relative ease in terms of technical effort, manpower and costs. There are twelve HF-radar sites, operated by five JERICO-NEXT partners, involved in Task 2.3. Together, they constitute 23.5% of the HF-radars currently operating in Europe.

Cabled observatories, on the other hand, offer the attractive advantage of freeing marine observing activity from the merciless restrictions of limiting power and constrained bandwidth for communication and data transfer. Such observatories can therefore be used with a broad variety of sensors and systems, and allows measurements to be made even under extreme conditions (e.g., storm events, under ice, etc.). Six such observatories are being operated by JERICO-NEXT partners, all of whom are participating in Task 2.3.

Task 2.3 of JERICO-NEXT deals specifically with the harmonization of the two types of observing elements mentioned above within the JERICO infrastructure network. It is divided into two subtasks, one for each kind of technology involved. The present document, constituting Deliverable D2.1 of the JERICO-NEXT project, gathers and reports on the outcomes of the two parts of the first workshop on HF-Radars and Cabled Observatories (MS9) that was planned within the task. From the standpoint of HF-radars, it provides an overview of the state-of-the-art methodologies utilized during the planning and installation phase of HF-radar sites, and reviews the main relevant operational aspects, applications, and quality assessment and data management issues. Additional information concerning the HF-radar event can be found here: http://www.jerico-ri.eu/download/JericoNext-HFR-workshop-Minutes_vf.pdf, and here: <http://www.jerico-ri.eu/project-information/meeting-reports/>. In the case of Cabled Observatories, the document provides descriptions of such systems and the way they are run, and critically assesses their current level of development from the specific perspective of operations in coastal waters.





2. Introduction

JERICO-NEXT aims to develop the infrastructural base necessary to meet Europe's present and future informational needs as concerns its coastal marine systems. One of the ways it plans to do this is by strengthening pan-European cooperation to render interoperable new observing systems and the existing JERICO observing network. HF-radars and cabled coastal observatories are examples of two such systems. HF-radar will contribute significantly to a better understanding and assessment of surface currents, sea states, and transport in the coastal zones. Cabled coastal observatories, appropriately instrumented, will permit sustained multi-disciplinary observations, including much-needed long-term time-series of biological variables. The assimilation of the two systems into the network will greatly advance its capacity to deliver data describing: (1) the interactions between physics, chemistry, biogeochemistry and biology in Europe's coastal seas, and (2) how marine ecosystems react to anthropogenic disturbances and global environmental change.

The first step in achieving this integration has been to describe and establish the current status of HF-radar systems and cabled coastal observatories within the JERICO network by bringing together the experts on the respective technologies in two separate workshops. The HF-radar workshop (MS9-1) was organized at San Sebastian in Spain from 09 to 11 March 2016, and the Cabled Observatories workshop (MS9-2) was held at Vilanova i la Geltrú in Portugal from 19 to 20 April 2016. This deliverable gathers and presents the outcomes and results of these workshops.

HF-radars, when they are utilized for marine monitoring purposes, typically operate in the band between 8 and 37 MHz corresponding to wavelengths of 8 - 37 m. At these wavelengths, the electromagnetic waves propagate along the electrically conductive water surface. Therefore, HF-radars enable to measure the radar backscatter beyond the line of sight, meaning beyond the horizon, which is why they are also called Over the Horizon Radars. In general, an HF-radar sends out pulses and listens to the returned signals, which are mainly affected by the surface waves propagating along the radar look direction. The returned signals are on the order of half the wave-length of the transmitted signal. From the measured backscatter, several parameters relevant to marine phenomena, such as ocean surface currents (Paduan and Rosenfeld, 1996; Gurgel et al., 1999), waves (Lipa and Barrick, 1986; Heron and Heron, 1998), winds (Heron and Rose, 1986; Shen et al., 2012), and tsunami [Lipa et al., 2006; Gurgel et al., 2011], can be retrieved. Attempts have also been made to use the technology for ship detection (Ponsford et al., 2001; Dzvonkovskaya et al. 2008) and tracking (Maresca et al., 2014).

Today, the two principal HF-radar paradigms that are being utilized in oceanography are the phased array and the direction-finding concepts. When it comes to their practical implementation, however, the two approaches sometimes have distinct





requirements from the viewpoints of installation, operation, and maintenance of hardware, as well as data quality control and management, due to their underlying differences. Therefore, where needed, this report distinguishes between phased array and direction-finding systems.

HF-radar systems have proved to be a cost-efficient way to monitor coastal waters up to 200 km offshore, making them a very attractive observing tool in coastal regions all over the world. Over the last years, the HF-radar community has been working towards the coordinated development of coastal HF radar technology and its products, based on the observation of surface ocean currents, at both the European and international levels. This effort is being carried out in the framework of the following different European and international initiatives: the EuroGOOS Ocean Observing HF-radar Task Team, EMODnet Physics, and the GEO GLOBAL HF-Radar Task. The EuroGOOS HF-Radar Task Team was set up in 2014 to promote coordinated activities in Europe in relation to the development and use of HFR technology. This dynamic group is linking its activities to the GEO GLOBAL HF-Radar Task to facilitate the adoption of harmonized HF-radar technologies at the European and international levels, and support relevant European end user requirements. In 2015, a pilot action coordinated by EMODnet Physics, with the support of the HF Radar Task Team, began to develop a strategy of assembling HF radar metadata and data products within Europe in a uniform way to make them easily accessible and more interoperable. The Group on Earth Observations (GEO) is also coordinating international efforts to build a Global Earth Observation System of Systems (GEOSS). The GEO Work Plan 2012-2015 endorsed a task to plan a Global HF-Radar Network for data sharing and delivery and to promote the proliferation of HF radars. NOAA (USA), with an international co-chaired group, has taken the lead in building this network, and in promoting activities relative to the task. An example of an integrated HF-radar network is provided by IOOS, which is already covering extensive coastal areas of the continental USA as well as Alaska, Hawaii and Puerto Rico using this technology. All these programmes are permitting access to HF-radar data from various regions in the world (e.g. <http://hfradar.ndbc.noaa.gov/>; <http://www.emodnet-physics.eu/Map/>).

Cabled observatories offer the attractive advantage of freeing marine observing activity from the merciless restrictions of limiting power and constrained bandwidth for communication and data transfer. Such observatories can conduct a wide range of long-term and innovative experiments within its confines using real-time control over the entire cabled system. A broad variety of sensors and systems can be used, and measurements can be made even under extreme conditions (e.g. storm events, under ice, etc.).





EMSO (European Multidisciplinary Seafloor Observation) is the European large-scale deep-sea observatory infrastructure for long-term monitoring of environmental processes relating to ecosystems, climate change, and geohazards. The EMSO initiative is based on developments stemming from EU projects dating back to 1990 that aimed at realizing and validating seafloor observatory and network prototypes. JERICO-NEXT will work with EMSO, seeking common solutions to technical challenges.

3. HF-Radars

In order to build an up-to-date inventory of operational HF-radar systems and operators, the EuroGOOS HF-radar Task team, in close collaboration with the JERICO-Next project and CMEMS' Service Evolution INCREASE project, launched a survey to diagnose the present status of different HFR systems available in Europe in summer 2016. The survey collected responses from 28 European institutions active (or planning to be active) in HF-radar work, and gathered aspects concerning several technical aspects on their installations (location, working parameters, data formats, sharing protocols and policies, QA/QC, applications). A total of 51 HF-radar sites (20 networks) were listed as operational.

| Operator | Country | Number & Type | Applications | Network | Location |
|--------------------------------------|---------|---------------|---------------------------|----------------|------------------|
| Euskalmet – Basque Government / AZTI | Spain | 2 DF | Cur, DA | Basque Country | SE Bay of Biscay |
| HZG | Germany | 3 PA | Cur, Wav, DA, SD | COSYNA | German Bight |
| ISMAR-CNR | Italy | 2 DF | Cur, DA (expected) | TirLig | Ligurian Sea |
| MIO-CNRS | France | 3 DF | Cur | MOOSE HF-Radar | Ligurian Sea |
| SOCIB | Spain | 2 DF | Cur, RT-MV, DA (expected) | Ibiza Channel | Ibiza Channel |

Table 1. HF-radar networks operated by JERICO-NEXT project partners. The acronyms are defined as follows: PA = phased array, DF = direction-finding, Cur = surface currents, Wav = surface waves, RT-MV: real-time, model-validation, DA = data assimilation, and SD = ship detection.

The operational networks identified in the ROOS areas were distributed as follows: 50% (10 networks) in MONGOOS, 30% (6 networks) in IBIROOS and 20% (4 networks) in NOOS. Details of the survey results can be found in Mader et al. 2016.





The JERICO-NEXT organizations involved with HF-radar systems contributing to the present report are listed in table 1, above. Together, they are responsible for 23.5% of the HF-radars being operated in Europe today. The table lists organization, country, HF-radar type, radar network and location. As can be seen, these radar networks are quite well-distributed geographically, representing three ROOS areas.

3.1 Introduction to HF-radar

The era of HF-radar for oceanographic applications started with Crombie [1955] who, observing the behavior of pulses transmitted at HF frequency (3 - 30 MHz) over the sea, noted Doppler shifts of the returned signal. He correctly identified these shifted signals, characterized by a wavelength half of that of the transmitted pulses, as the result of Bragg scattering from waves on the sea surface travelling along the look direction of the radar. As HF-radars operate with wavelengths of tens of meters, they interact directly with the energetic ocean surface waves. At these wavelengths, the electromagnetic waves propagate along the electrically conductive water surface, and can therefore be used to measure the radar backscatter beyond the line of sight. HF-radar systems used for oceanographic applications estimate the range distance and azimuthal direction as well as the Doppler frequency and returned power of the ocean surface.

The simplest method for measuring the range distance is by sending out a short pulse and measuring the time between the transmission and reception. However, for a good resolution, a short pulse is needed, which leads to low transmitted power and in turn to a low signal to noise ratio. To overcome these drawbacks, today's HF-radars transmit long frequency-modulated (interrupted) continuous-wave (FM(I)CW) signals. The radar transmits a linear frequency chirp, where the frequency shift between the transmitted and received signal determines the range distance of the ocean surface patch to the radar. The range cell resolution is related to the bandwidth of the chirp.

For getting an azimuthal coverage over the ocean surface, one method is to point the radar (beamforming) in different directions (radar look directions). To achieve this condition, several systems have been developed, which differ mainly in their antenna design. The simplest antenna system is a phased array of identical receiving elements spaced at an equal distance below half the electromagnetic wavelength along a line perpendicular to the center of the desired beam directions. The time delay between antennas on this line is used to sequentially point the radar in different directions. An alternative to the beamforming method is the so called direction-finding technique. It is based on comparing the relative phases and amplitudes of the returned signals on a number of directional antennas located at the same point. With a known antenna beam pattern for each receiving antenna, the direction of the received signal can be retrieved via the MUSIC (MUltiple Signal Classification) algorithm. In contrast with the phased-array method where a sequential set of spectra is used to get information over the azimuth, in the direction-finding method, a single composite spectrum is analyzed.





The Doppler resolution is retrieved by repeating the range measurements at a regular rate and performing a time series analysis on each individual range measurement. The coherent integration time T provides a frequency resolution $\Delta f = 1/T$, which in turn gives the velocity resolution of $\Delta v = \lambda \Delta f / 2$ where λ is the radar wavelength.

3.2 Phased-array and direction-finding systems

The phased-array and direction-finding concepts differ significantly in terms of antenna design, and therefore setups. Figure 1 shows a typical phased-array system, which consists of a transmit Tx and a receive Rx antenna array. Each antenna is a pole with a height varying usually between 1 to 3 m depending on the manufacturer and the utilized transmission frequency. The Tx array consists of 4 antennas set up in a rectangular pattern ($0.45\lambda \cdot 0.15\lambda$) at a distance of at least 100 m with respect to the Rx array which extends over a distance of $0.45\lambda \cdot (n - 1)$, where n is the number of antennas.

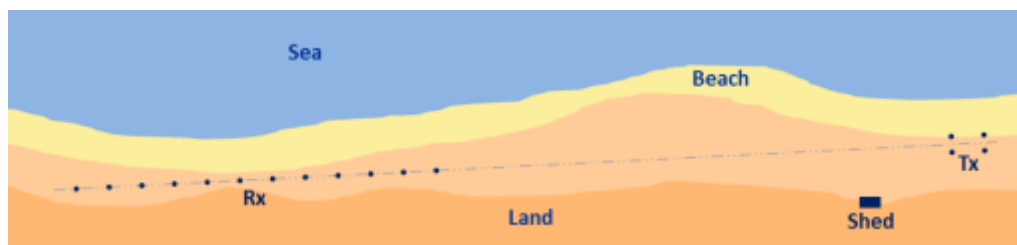

Figure 1. Typical setup of a phased array HF-radar system.



Figure 2. The photos show a phased array setup of a Wera system on the island of Sylt on the German coast of the North Sea. The left hand side shows the transmitter antenna array (Tx) and the right hand side the receive array (Rx). The system is one of the three HF-radars installed within the framework of the COSYNA Project to help monitor the German Bight.

The Rx setups can comprise between 8 and 16 antennas; the greater the number of antennas, to the higher the azimuthal resolution. Figure 2 illustrates the setup of a phased array on the island of Sylt on the German coast of the North Sea.





In Figure 3, the setup of a standard/long range direction-finding system is illustrated. A system of this kind typically consists of one Tx antenna with a height on the order of 10 m, depending on the operating frequency, and one separate Rx antenna system constituted by one dome loopstick antenna unit and a vertical element with dimensions similar to those of the transmitting antenna. On new systems, with the exception of long range ones (operating at about 4MHz), the Tx and Rx antennas are combined on the same pole.

The older direction-finding systems operate with 4 receiving antennas which are set up in a rectangle like the Tx antennas of a phased array system. In Figure 3 (right), the standard range (13,5 MHz) SeaSonde direction finding system operating at Marina Di Ragusa in Sicily, Italy, is shown.



Figure 3. The left panel illustrates a typical setup of a standard/long range direction-finding HF-radar system. The right panel shows a SeaSonde direction-finding system installed at Marina Di Ragusa in Sicily, Italy. This system is one of the four HF-radars that were set up within the CALYPSO Project to monitor sea-surface currents in the Malta-Sicily Channel.

3.3 Applications

Today, oceanographic HF-radars are mainly utilized to measure ocean surface current fields (Paduan and Rosenfeld, 1996; Gurgel et al., 1999) for various applications such as search and rescue (Ullman et al., 2006), oil spill monitoring (Abascal et al., 2009), marine traffic information (Breivik and Sætra, 2001) or improvement as well as data assimilation of numerical circulation models (Paduan and Schulman, 2004; Barth et al., 2008). The considerable number of existing HF-radar networks, in particular along the European, Australian and North American coasts, provides near-real-time ocean surface velocity maps covering large areas. Figure 4 shows a surface current field resulting from the HF-radar network at the Hook of Holland, North Sea, as well as the associated eastward and northward components over time from the location marked by the red dot. These surface





current fields are retrieved by the Dutch Rijkswaterstaat on an operational basis every 20

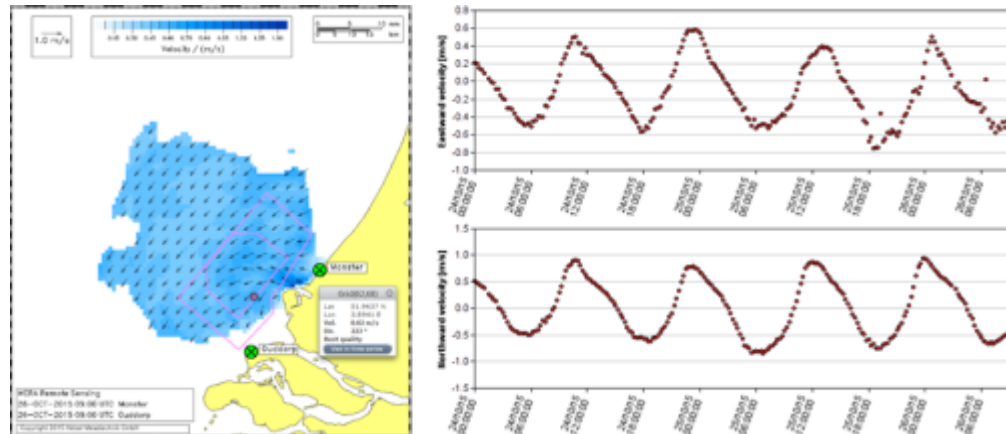

minutes for ship guidance to the port of Rotterdam.

Figure 4. Surface current map from 26.October 2015 at 9:00 UTC resulting from the HF-radar network at the Hook of Holland, southern North Sea (left panel). The upper and lower panels on the right show the eastward and northward components of the surface currents over a 56 h period at the location marked by the red dot in the map on the left.

In addition, several HF-radar systems also provide information on the significant wave height (Heron and Heron, 1998), and a few systems even on spectral wave properties such as the wave spectrum (Wyatt, 1990). Other applications of HF-radars include surface wind retrieval (Heron and Rose, 1986; Shen et al., 2012), as well as tsunami (Lipa et al., 2006; Gurgel et al., 2011) and ship detection (Ponsford et al., 2001; Maresca et al., 2014). Of these, the last two are becoming more and more widespread. Figure 5 shows ship detection and tracking results from 01 August 2013 between 6:00 and 9:00 UTC obtained by means of the HF-radar systems operating in the German Bight.



Figure 5. Map of ship detects in the German Bight resulting from the fusion of HF-radars at Wangerooze and Büsum, covering the German Bight of the southern North Sea. The ship detects are plotted in green and the corresponding positions of the Automatic Identification System (AIS) are depicted in grey.



3.4 Planning and installation phase

One of the most important activities in the planning phase is the selection of the desired resolution, range and coverage of the HF-radar, together with the major parameter of interest (in the majority of today’s setups, these are ocean surface currents). Depending on these criteria, the operating frequency as well as the number of systems and their relative locations can be defined. Table 2, lists the typical operating ranges and resolutions for phased array as well as direction-finding systems. Note that these numbers are those given by the manufacturers of Wera and SeaSonde systems, and they may differ from systems produced by other manufacturers. It is very important to evaluate the different advantages and disadvantages of the individual systems available so as to come up with the best system suited for a specific application and area.

| | ITU frequency bands (kHz) | Radar wavelength (m) | ocean wavelength (m) | ocean wave period (s) | Equivalent integration depth for current (cm) | Typical range resolution (km) | Typical maximum range for current analysis (km) |
|-----------------|---------------------------|----------------------|----------------------|-----------------------|---|-------------------------------|---|
| Long Range | 4.438 4.488 | 67 | 34 | 4,6 | 420 | 12 | 220 |
| | 5.250 5.275 | 57 | 28 | 4,3 | 356 | 12 | 175 |
| | 9.305 9.355 | 32 | 16 | 3,2 | 201 | 12 | 80 |
| Medium range | 13.450 13.550 | 22 | 11 | 2,7 | 139 | 3 | 60 |
| | 16.100 16.200 | 19 | 9 | 2,4 | 116 | 3 | 60 |
| | 24.450 24.600 | 12 | 6 | 2,0 | 76 | 1 | 30 |
| High Resolution | 26.200 26.350 | 11 | 6 | 1,9 | 71 | 1 | 30 |
| | 39.000 39.500 | 8 | 4 | 1,6 | 48 | 300 m | 20 |
| | 42.000 42.500 | 7 | 4 | 1,5 | 44 | 250 m | 15 |

Table 2. Typical operational frequencies of HF-radar systems, and the corresponding coverage and resolution.

The next step is to identify potential installation sites. This has to be done carefully taking into account many things: relative location (of the sites to each other), available space (depending on the type of system), infrastructure availability and status (power supply, accessibility), and sources of possible interaction (e.g. other nearby antennas, metal fences, etc.). Possible sites should be chosen to satisfy logistical prerequisites first, before going on to fulfill the specific requirements in relation to the particular application, the coverage and the resolution. It is recommended to monitor the HF-spectrum at the selected sites in order to identify any interference issues and to plan appropriate countermeasures, e.g. selecting the most suitable frequencies. Figure 6 shows a simple setup that was used to monitor the background noise prior to the installation of a system for the Ligurian Sea in the Mediterranean basin in 2009.





Figure 6. A simple radio setup used by the Nato Undersea Research Center, Italy, to monitor the HF-radio band for identifying the most suitable frequency and site from the standpoint of background noise.

3.5 Main Operational Issues

During operation, there are various factors which either affect the radar performance directly, and therefore the accuracy of the measurements, or lead to an interruption of the data flow. Generally, data coverage is not regular for a number of reasons. Spatial and temporal data gaps may occur at the outer edge, as well as inside the measurement domain. This can be due to several environmental and/or electromagnetic causes: the lack of Bragg scattering ocean waves or severe ocean wave conditions, low salinity environments, and the occurrence of radio interference (Figure 7).

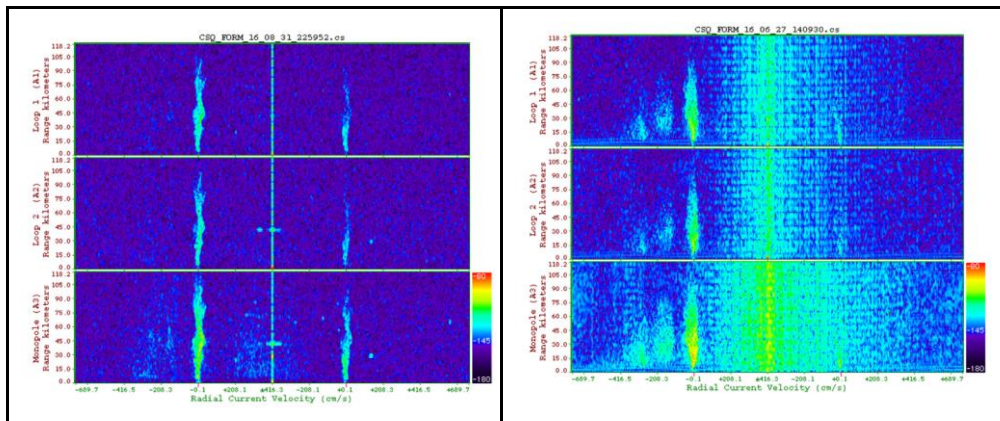



Figure 7. Spectral plots showing vertical electromagnetic interference stripes over range for the three antennas of the 13.5 MHz SeaSonde at FORM in the Ibiza Channel. The plot on the left shows spectra without electromagnetic interferences.

In the worst case of a complete system failure, a permanent gap in the time record will occur. With respect to radar performance, the most frequent problems arise from environmental changes, which lead to changes of the electromagnetic field in the vicinity of the antennas and therefore to invalid antenna patterns and calibration parameters. Changes of antenna patterns are more significant for direction-finding systems than for phased array systems. Another problem is the quality loss or failure of antennas due to the environment. This happens more frequently to phased array systems as significantly more antennas are involved. For phased array systems, the performance is strongly affected if the Tx array and/or antennas close to the center of the Rx array are compromised in some way. Usually, these problems arise from damaged or broken cables, connectors or radials caused by wildlife or vandalism (Figure 8).

The unreliability of internet connections is also a complication. A breakdown of the internet connection can lead to measurement gaps in the long-term record. The stability of the power supply, particularly at very remote sites, can also be a problem. These can lead to permanent data gaps but typically do not occur very often, and can be mitigated by using UPSs.

Further dangers to operational integrity include malfunctions or downtime arising from air-conditioning failures, electromagnetic interferences, lightning strikes, accidental fires, coastal erosion and inherent system weaknesses.





Figure 8. Damaged antenna.

3.6 Quality Assessment

The first integrated approach to define a standard set of Quality Assurance (QA) and Quality Control (QC) procedures for HF-Radar data is presently being pursued in the framework of the cooperation between JERICO-NEXT, the EuroGOOS HF-radar Task Team and EMODnet Physics. The current step of this process has been the analysis of the state of the art of QC testing procedures for HF-Radar surface current observations. The results of the analysis will be complemented by discussions aimed at identifying the best set of QC tests to be adopted as a standard procedure for real-time HF-Radar data at the European level.

The analysis of the state of the art was mostly based on the activity of the US Integrated Ocean Observing System (IOOS), that continues to establish written, authoritative procedures for the QC of real-time data through the Quality Assurance of Real-Time Oceanographic Data (QARTOD) program. In particular, the manuals on the real-time QC of HF-Radar surface currents periodically produced by the QARTOD program were used as references for the discussion. The latest draft version of this manual, available at the URL: https://ioos.noaa.gov/wp-content/uploads/2016/06/HFR_QARTOD_Manual_05_26_16.pdf, has already identified some shortcomings of earlier versions, and includes suggestions for some new QC tests that may be employed.

The focus of the manual is on the real-time QC of data collected, processed, and disseminated by the U.S. IOOS Regional Associations, and is limited to HF-Radar surface current data. Data are evaluated using QC tests, and the results of the tests are recorded by inserting flags in the data record. The flags used by the IOOS are the UNESCO 2013 QC flags for real-time data. Table 3 lists these flags and the associated descriptions.

| Flag | Description |
|-------------------------------|--|
| Pass=1 | Data have passed critical real-time quality control tests and are deemed adequate for use as preliminary data. |
| Not evaluated=2 | Data have not been QC-tested, or the information on quality is not available. |
| Suspect or Of High Interest=3 | Data are considered to be either suspect or of high interest to data providers and users. They are flagged suspect to draw further attention to them by operators. |
| Fail=4 | Data are considered to have failed one or more critical real-time QC checks. If they are disseminated at all, it should be readily apparent that they are not of acceptable quality. |
| Missing data=9 | Data are missing; used as a placeholder. |



Table 3. UNESCO 2013 Quality control flags for real-time data.

The QARTOD manuals review a variety of tests that can be performed to evaluate data quality in real-time. These tests presume a time-ordered series of observations, and are listed in Table 4.

| Test Type | Test Name | Status | Test Control |
|--|---|-----------|--------------------|
| Signal (or Spectral) Processing | Signal-to-Noise Ratio (SNR) for Each Antenna (Test 1) | Required | Embedded |
| | Cross-Spectra Covariance Matrix Eigenvalues (Test 2*) | Suggested | Embedded |
| | Single and Dual Angle Solution - Direction of Arrival (DOA) Metrics (magnitude) (Test 3*) | Suggested | Embedded |
| | Single and Dual Angle Solution - Direction of Arrival (DOA) Function Widths (3 dB) (Test 4*) | Suggested | Embedded |
| | Single and Dual Angle Solution - Direction of Arrival (DOA) Signal Amplitude Matrices (Test 5*) | Suggested | Embedded |
| | Signal-to-noise Ratio for Bragg Peaks (Test 6~~) | Suggested | Embedded |
| | Separation of 1st order Bragg Lines (Test 7~~) | Suggested | Embedded |
| | Broadening of Bragg Lines (3 dB) (Test 8~~) | Required | |
| Radial Components | Syntax (Test 9) | Required | National |
| | Max Threshold (Test 10) | Required | Local and National |
| | Over-Water (Test 11) | Required | Local and National |
| | Angular Section Coverage (Test 12*) | Required | Local and National |
| | Median Filter (Test 13*) | Suggested | Local and National |
| | Trend Limits (Test 14) | Suggested | |



| | | | |
|----------------------|--|-----------|--------------------|
| | Temporal Gradient (Test 15) | Suggested | |
| | Spatial Gradient (Test 16) | Suggested | |
| | Average Radial Bearing (Test 17) | Suggested | |
| | Synthetic Radial Test (Test 17.5) | Suggested | |
| Total Vectors | Data Density Threshold (Test 18*) | Required | Local and National |
| | GDOP Threshold (Test 19) | Required | Local and National |
| | Max Speed Threshold (Test 20) | Required | Local and National |
| | Trend Limits for u, v components (Test 21) | Suggested | |
| | Median Filter (Test 22*) | Suggested | Local and National |
| | Measured Minus Modeled (Test 23) | Suggested | Local and National |

Table 4. QARTOD list of Quality Control tests for real time HF-radar data. Tests accompanied by “~” apply only to WERA and LERA systems (phased array), while those appended with “*” apply only to SEASONDE systems (direction-finding).

The QARTOD manual divides these tests into three groups: those that are required, strongly recommended, or suggested, according to the QC strategy of the IOOS. Table 5 shows the three groups.

Operators need to select the best thresholds for each test, which are determined at the operator level and may require “trial and error” testing before optimal values can be established. A successful QC effort is highly dependent upon the selection of the proper thresholds, which should not be determined arbitrarily but must be based on historical knowledge or statistics derived from more recently acquired data. The ongoing discussion within the JERICO-NEXT project is focused on this point, and aims to define a set of QC tests which could be adopted as common standard procedures within the European HF-radar network.

Most of the tests presented in the QARTOD manuals are specific for Codar SeaSonde systems due to the fact that the US HF-radar network is mainly employing these kinds of systems. The European situation is quite different, as both Codar and WERA systems are being used. Thus, the JERICO-NEXT partnership is working with both Codar and WERA users in order to identify WERA-relevant QC parameters, tests and flags.



| | | |
|---|--|---|
| <p>Group 1 <i>Required</i></p> | <p>Test 1 Test 8 Test 9 Test 10 Test 11 Test 12 Test 18 Test 19 Test 20</p> | <p>Signal-to-Noise Ratio Broadening of Bragg Lines (3 dB)~~ Syntax Max Threshold Over-Water (radial components) Angular Section Coverage Data Density Threshold GDOP Threshold Max Speed Threshold</p> |
| <p>Group 2 <i>Strongly Recommended</i></p> | | <p>None.</p> |
| <p>Group 3 <i>Suggested</i></p> | <p>Test 2 Test 3 Test 4 Test 5 Test 6 Test 7 Test 13 Test 14 Test 15 Test 16 Test 17 Test 17.5 Test 21 Test 22 Test 23</p> | <p>Cross Spectra Covariance Matrix Eigenvalues* Single and Dual Angle Solution-DOA Metrics (magnitude)* Single and Dual Angle Solution – DOA Function Widths (3 dB)* Single and Dual Angle Solution – DOA Signal Amplitude Matrices* Signal-to-Noise Ratio for Bragg Peaks~~ Separation of 1st order Bragg Lines~~ Median Filter (radial components) Trend Limits (radial components) Temporal Gradient Spatial Gradient Average Radial Bearing Synthetic Radial Trend Limits for u,v components (total vectors) Median Filter (total vectors) Measured Minus Modeled (total vectors)</p> |

Table 5. The QARTOD QC test hierarchy.

The final goal of the discussion at the European level on QC procedures is therefore to integrate the QARTOD list of tests with new tests relevant to WERA and LERA systems, and then to define a set of mandatory tests to adopt as standard QC procedures for the European HF-radar network. These standard tests will cover both radial and total velocity data, and they will be required for labeling the data as Level 2B (for radial velocity) or Level 3B (for total velocity). European HF-radar operators will thus be able to choose the order of QC tests





they want to implement in their processing workflow based on an established, documented test hierarchy. Data processed with additional QC tests aside from the mandatory ones will be labeled as Level 2C (for radial velocity) or Level 3C (for total velocity).

3.7 Data Management

While all radar types share the same principles of operation, differences in signal transmission, reception and processing lead to variations in metadata, Quality Assessment (QA) procedures, Quality Control (QC) metrics and spatial registration. Even when they are of the same type, HF-radars may have different spatial ranges and resolutions, depending typically on the working frequency and bandwidth availability. Building on the successful experience of the Italian RITMARE project and EuroGOOS strategy, many efforts are underway within the European HF-radar community to homogenize HF-radar data and metadata formats and relative QA/QC procedures. These efforts are being promoted in order to try and reach the level of standardization necessary to establish an effective European HF-radar network. In fact, the relevant activities being carried out within JERICO-NEXT are focusing on the definition of recommended common metadata and data models and QC procedures. This will serve to enable HF-radar data collected by the JERICO network to comply with the international standards regarding their quality and metadata, assuring at the same time the interoperability needed to successfully integrate a significant part of Europe's HF-radar systems.

The NetCDF (Network Common Data Form) format has been chosen as the standard data format for HF-radar data in JERICO-NEXT, the main reason being that it is the international standard for sharing data and the one which has already been adopted by the US HF-radar community. This choice is coherent with the long-term goal of integrating the future European HF-radar network with that of the US. Thus, the selected reference conventions for data and metadata structures are the Unidata Dataset Discovery Convention and, consequently the Unidata Attribute Convention for Data Discovery (ACDD), the Climate Forecast Metadata Convention CF-1.6 and the INSPIRE directive. These sets of regulations guarantee adherence to the main international and European conventions for metadata architectures. On the basis of the data format and the metadata conventions, the CF-1.6 standard vocabulary (necessary to build the standard terms that can be used by search services in interoperable and semantic data discovery frameworks) has been adopted. The common set of metadata for the description of data sets (i.e. information about data collection, dataset availability and licensing, etc.), variables (i.e. geophysical quantities and their related statistical accuracy indicators) and attributes (i.e. standard fields describing coverages, keywords, topics, etc.) has also been specified.

Thanks to these steps, JERICO-NEXT is defining a potential European standard for HF-radar data (both radial and total velocity data) and metadata. The discussion concerning the fine-tuning of the final set of metadata, to be endorsed in cooperation with the RITMARE project partnership, the EuroGOOS HF-radar Task Team and the EMODnet community, is still ongoing.





It is obvious that the definition of the standard metadata structure also takes QC into account. A specific variable has been included in the common variable list of the netCDF format to denote the QC-flag that will be used for labelling the data. The values to be assigned to the flags are still under discussion as they will hinge on the final set of standard QC standard procedures that is still being formulated clearly, the delineation of this set of procedures will depend on the characteristics of the processing levels that will be used to differentiate submitted HF-radar data. The organization of the metadata structure includes a specific field for indicating the data processing level. The formalization of the processing levels has been accomplished in a way that makes them manufacturer-independent, i.e. the levels are compatible with all the principal HF-radar systems in use, namely Codar, WERA and LERA. Table 6 lists and describes the different processing levels.

| Processing Level | Definition | Products |
|------------------|---|--|
| LEVEL 0 | Reconstructed, unprocessed instrument/payload data at full resolution; any and all communications artifacts, e.g. synchronization frames, communications headers, duplicate data removed. | Signal received by the antenna before the processing stage. (No access to these data in Codar systems) |
| LEVEL 1A | Reconstructed, unprocessed instrument data at full resolution, time-referenced and annotated with ancillary information, including radiometric and geometric calibration coefficients and georeferencing. | Doppler spectra per antenna |
| LEVEL 1B | Level 1A data that have been processed to sensor units for next processing steps. Not all instruments will have data equivalent to Level 1B. | Directional Doppler spectra (only in beamforming) |
| LEVEL 2A | Derived geophysical variables at the same resolution and locations as the Level 1 source data. | Radial velocity data |
| LEVEL 2B | Level 2A data that have been processed with a minimum set of QC. | Radial velocity data |
| LEVEL 2C | Level 2B data that have been processed with «custom» QC procedures. | Radial velocity data |
| LEVEL 3A | Variables mapped on uniform space-time grid scales, usually with some completeness and consistency | HFR total velocity data |



| | | |
|-----------------|--|--|
| LEVEL 3B | Level 3A data that have been processed with a minimum set of QC. | HFR total velocity data |
| LEVEL 3C | Level 3B data that have been processed with «custom» QC procedures. | HFR total velocity data |
| LEVEL 4 | Model output or results from analyses of lower level data, e.g. variables derived from multiple measurements | Energy density maps, residence times, etc. |

Table 6. Processing levels for differentiating HF-Radar data.

3.8 References

- Abascal, A. J., Castanedo, S., Medina, R., Losada, I. J., & Alvarez-Fanjul, E. (2009). Application of HF radar currents to oil spill modelling. *Marine pollution bulletin*, 58(2), 238-248.
- Barth, A., Alvera-Azcárate, A., & Weisberg, R. H. (2008). Assimilation of high-frequency radar currents in a nested model of the West Florida Shelf. *Journal of Geophysical Research: Oceans*, 113(C8).
- Breivik, Ø., & Sætra, Ø. (2001). Real time assimilation of HF radar currents into a coastal ocean model. *Journal of marine systems*, 28(3), 161-182.
- Crombie, D.D. (1955). Doppler spectrum of sea echo at 13.56 Mc/s. *Nature*, 175, 681-682.
- Dzvonkovskaya, A., Gurgel, K. W., Rohling, H., & Schlick, T. (2008, September). Low power high frequency surface wave radar application for ship detection and tracking. In *2008 International Conference on Radar* (pp. 627-632).
- Gurgel, K. W., Antonischki, G., Essen, H. H., and Schlick, T. (1999). Wellen Radar (WERA): a new ground-wave HF radar for ocean remote sensing. *Coastal Engineering*, 37(3), 219-234.
- Gurgel, K. W., Dzvonkovskaya, A., Pohlmann, T., Schlick, T., & Gill, E. (2011). Simulation and detection of tsunami signatures in ocean surface currents measured by HF radar. *Ocean Dynamics*, 61(10), 1495-1507.
- Heron, M., & Rose, R. (1986). On the application of HF ocean radar to the observation of temporal and spatial changes in wind direction. *IEEE journal of oceanic engineering*, 11(2), 210-218.
- Heron, S. F., & Heron, M. L. (1998). A comparison of algorithms for extracting significant wave height from HF radar ocean backscatter spectra. *Journal of Atmospheric and Oceanic Technology*, 15(5), 1157-1163.
- Lipa, B. J., & Barrick, D. E. (1986). Extraction of sea state from HF radar sea echo-Mathematical theory and modeling. *Radio Science*, 21(1), 81-100.
- Lipa, B. J., Barrick, D. E., Bourg, J., & Nyden, B. B. (2006). HF radar detection of tsunamis. *Journal of Oceanography*, 62(5), 705-716.



- Paduan, J. D., & Rosenfeld, L. K. (1996). Remotely sensed surface currents in Monterey Bay from shore-based HF radar (Coastal Ocean Dynamics Application Radar). *Journal of Geophysical Research: Oceans*, 101(C9), 20669-20686.
- Paduan, J. D., & Shulman, I. (2004). HF radar data assimilation in the Monterey Bay area. *Journal of Geophysical Research: Oceans*, 109(C7).
- Ponsford, A. M., Sevgi, L., & Chan, H. C. (2001). An integrated maritime surveillance system based on high-frequency surface-wave radars. 2. Operational status and system performance. *IEEE Antennas and Propagation Magazine*, 43(5), 52-63.
- Maresca, S., Braca, P., Horstmann, J., & Grasso, R. (2014). Maritime surveillance using multiple high-frequency surface-wave radars. *IEEE Transactions on Geoscience and Remote Sensing*, 52(8), 5056-5071.
- Shen, W., Gurgel, K. W., Voulgaris, G., Schlick, T., & Stammer, D. (2012). Wind-speed inversion from HF radar first-order backscatter signal. *Ocean Dynamics*, 62(1), 105-121.
- Stewart, R. H. and J. W. Joy, (1974). HF radio measurements of surface currents. *Deep-Sea Res.*, 21.1039-1049.
- Ullman, D. S., O'Donnell, J., Kohut, J., Fake, T., & Allen, A. (2006). Trajectory prediction using HF radar surface currents: Monte Carlo simulations of prediction uncertainties. *Journal of Geophysical Research: Oceans*, 111(C12).
- Wyatt, L. R. (1990). A relaxation method for integral inversion applied to HF radar measurement of the ocean wave directional spectrum. *International Journal of Remote Sensing*, 11(8), 1481-1494.





4. Cabled Observatories

The organizations involved with coastal cabled observatories in the JERICO-NEXT network are listed in table 1, together with their countries of provenience and the names and locations of the single installations. An in-depth analysis of the different installations, based on their common functionalities, is presented in the following sub-sections. The goal has been to try and establish the state-of-the-art of this technology within the network, with a view towards identifying strengths, weaknesses and a shared strategy for future development.

| Organization | Country | Installation | Location |
|--------------|---------|--------------|---|
| UPC | Spain | OBSEA | Barcelona, Catalan Coast (Spain), Western Mediterranean |
| SBI | Ireland | CPO | Galway Bay, Ireland, Atlantic Ocean |
| FMI | Finland | UTÖ | Utö Island, Archipelago Sea, Baltic Sea |
| IFREMER | France | EMSO-Molene | Molène Island, France, Atlantic Ocean |
| IMR | Norway | LoVe | Norwegian Sea |
| AWI | Germany | UNH | German Bight, North Sea |
| | | UNS | Kongsfjord (Ny Ålesund), North Sea |

Table 7. Cabled coastal observatories operated by JERICO-NEXT project partners.

4.1 Issues during the installation phase

Issues needing attention: site selection and approvals, manufacturer/s, environmental concerns such as electromagnetic pollution and other kinds of territorial impacts, cable deployment practices, power, and communications.

4.1.1 OBSEA

❖ Site selection and approvals

OBSEA is located in a marine protected area, accessible to divers. It is near a shore station, roughly 5 kilometres away, and is a very lightweight structure. In the design of the installation, the UPC's SARTI group needed to take care of the following:

- the setup of the base structure, to allow for the integration of several kinds of instruments;





JERICO-NEXT

- the setup of the Local Area Network (LAN) UDP & TCP/IP;
- the transmission capacity (1Gbps), which had to be high;
- the Node Power Supply (300 VDC), which had to be affordable;
- the implementation of the system's suite of oceanographic instruments(12/48 VDC);
- transport and commissioning, which had to be as easy as possible;
- system flexibility: multiple-instrument capability;
- the laying of 5 Km of underwater cable, supplied by Telefonica.



Figure 9. The Marine Protected Area where OBSEA is located.

❖ **Manufacturer**

The observatory was engineered using the resources of the UPC, and manufactured by local workshops such as STECMA, FELCO, BASTAN and Simgratec. Most of the electronics (Ethernet switches, power supplies, sun-rack, etc. are standard modules, and the underwater connectors were provided by GISMA, Seacon, Impulse or Subconn, all well-known European companies.

❖ **Environmental concerns (electromagnetic pollution and other territorial impacts)**

The SARTI team made a study of the area before deployment. It was concluded that no vegetation could be affected. In order to avoid problems of inadvertent human contact with the power-data cable on the beach side, this portion of the cable was run through an iron pipe.

❖ **Cabled Deployment, Power and Communications**



JERICO-NEXT

OBSEA uses one fiber optic cable and one power cable from the station to the beach manhole. Instead, from the manhole to the subsea node, a hybrid cable is employed. This cable is composed of a copper tube set to -300 VDC, and an aluminium screen connected to ground.

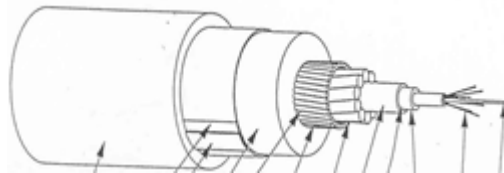

Figure 10. The OBSEA hybrid cable, deployed from land to the subsea node.

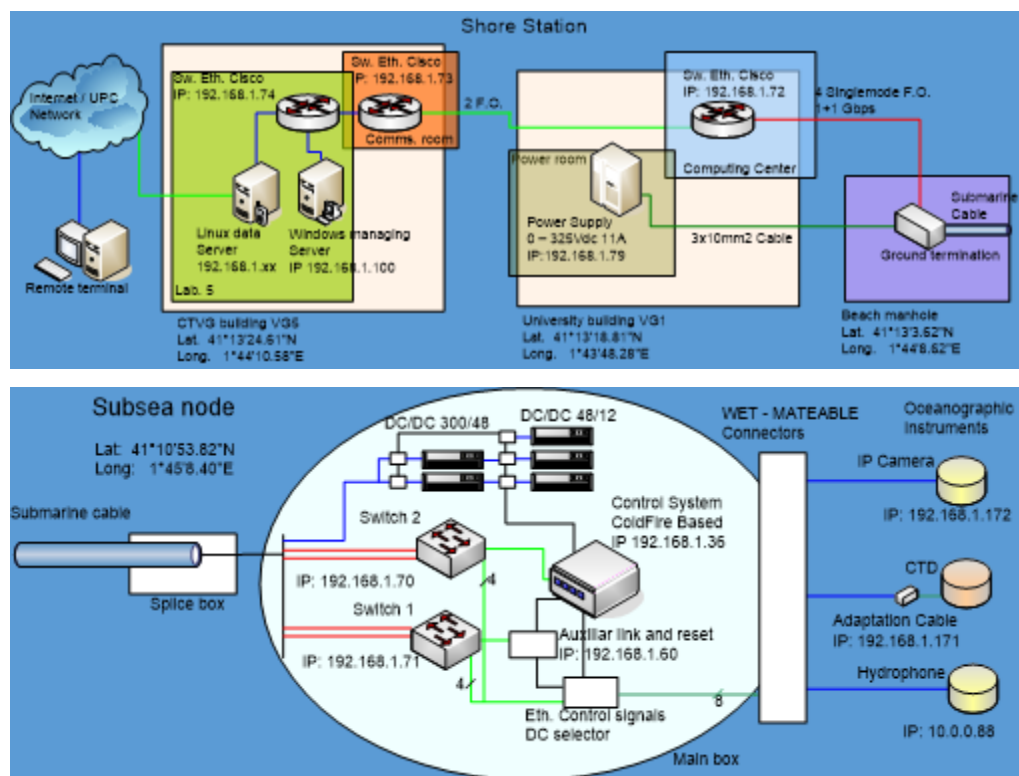

Figure 11. The OBSEA network.

4.1.2 CPO



JERICO-NEXT

The observatory is part of the Galway Bay marine and renewables test site (Smartbay Test Site), located 1.5 km off Spiddal at a depth of about 25 m. The frame holding the underwater node and most scientific instrumentation was deployed in August 2015 in the SW corner of the Test Site. A cable connecting the observatory to shore, providing power and data links to the instruments, was installed in April 2015, running from the Test Site to the pier in Spiddal; after landing in the pier (junction made in a manhole located at the end of the pier), the cable goes underground along the pier and public roads up to the shore station in a public facility nearby.

Site selection for the observatory was included in the overall Test Site selection; however, consenting and licensing aimed at the installation of the cable and observatory was kept separate from the Test Site licensing, with an exclusive application to the Foreshore License Unit; this included specific environmental and archeological assessment, as required; a license was granted for 10 years. There were no major consenting issues except:

1. cable route - possible impact on fishing grounds (local fishermen)
2. observatory site - possible impact on shrimp grounds

The cable to the observatory was laid down in phases:

1. Shore Station to Spiddal Pier end (2014)
2. Spiddal Pier end to Test Site (April 2015) - RV Celtic Explorer temporarily fitted with cable laying equipment
3. the cable was then reinforced with armour shells and rocks in the first 30m from the pier, and then buried in the seabed (to 60cm).



Figure 12. Galway Bay Marine Test and Demonstration Facilities.



JERICO-NEXT

All junctions and cable sections were checked for losses and proper connectivity all along; this allowed the identification of a problem in the fibre in the land section, which was replaced. It has been found recently that some of the rocks and armour shells have been removed by currents/waves, leaving the cable exposed close to the end of the pier; this has been corrected in with further rock laying.

The Cable Termination Unit (CTE) with two underwater mateable connectors was laid together with the last section of the cable (the marine section) in April 2015. The connectors allow for the unmating of the cable at the near end (the Cable End Equipment, see below). The cable is therefore a permanent installation but all the equipment installed underwater can be brought to the surface.

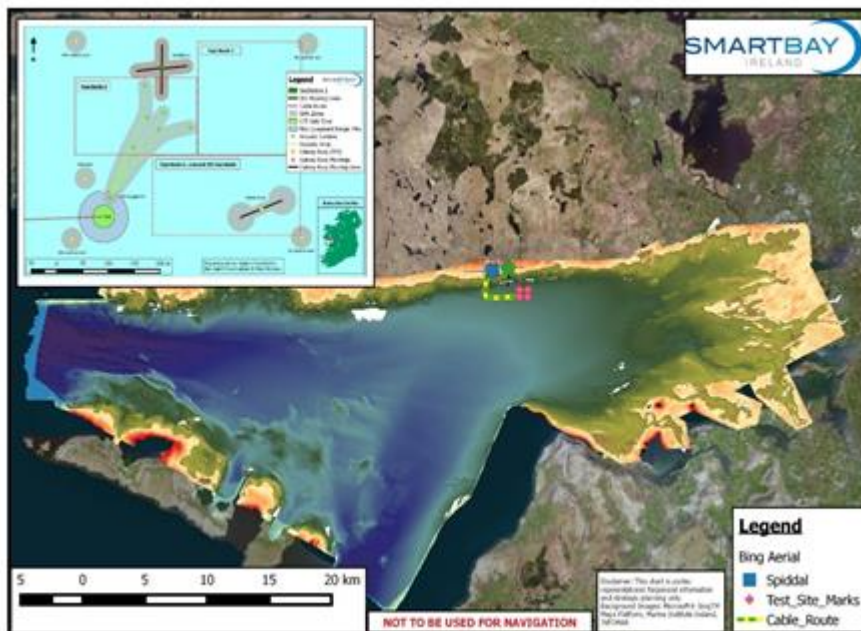

Figure 13. The Galway Bay area.

The Cable End Equipment (CEE) was deployed four months later (August 2015), and connected to the cable via the connectors referred to above. The CEE provides power and data links to a variety of instruments. During testing of the CEE, which took place in the four weeks before deployment, a number of issues were found and solved:

- the underwater lamps did not work properly (this was due to undocumented lamp power inrush at startup);
- reversal of polarity on all adapter whips power terminals (solved with proper whips being made);
- planned position for the underwater camera turned out to be not adequate (reposition of the camera after testing several locations);
- settings on CEE power boards (fine-tuning of the power boards via software).



4.1.3 UTÖ

The Uto Atmospheric and Marine Research Station (<http://en.ilmatieteenlaitos.fi/uto>) on Utö Island in the Baltic Sea has been built during the period 2012-2015 (part of the construction still on-going). The station is located in a military area, which has positive and negative implications. The reason for choosing the site was the large amount of existing measurements FMI has for Utö already: meteorological measurements since 1881, oceanographic measurements since 1900 and air quality measurements since 1980, combined with good logistics (minimum four free ferries to the island per week; availability of electricity and an optical fiber network; the presence of a hotel on island; existing FMI observations for the area; location in the Archipelago Sea). The actual position of the site in a military area is slightly challenging from an international cooperation perspective, but it was determined by the local wind field, bottom bathymetry, archeology, support from the Navy, and safety and building permits (finding a scientifically and legally suitable building site in a national park is difficult).

The technical challenges were many: all cables needed protection for sea-ice; waves make scheduling of underwater work difficult; material selection for instruments are challenging due to corrosion; lightning and signaling safeguards had to be carefully planned, and had to be partly redesigned after the first experiences with them.

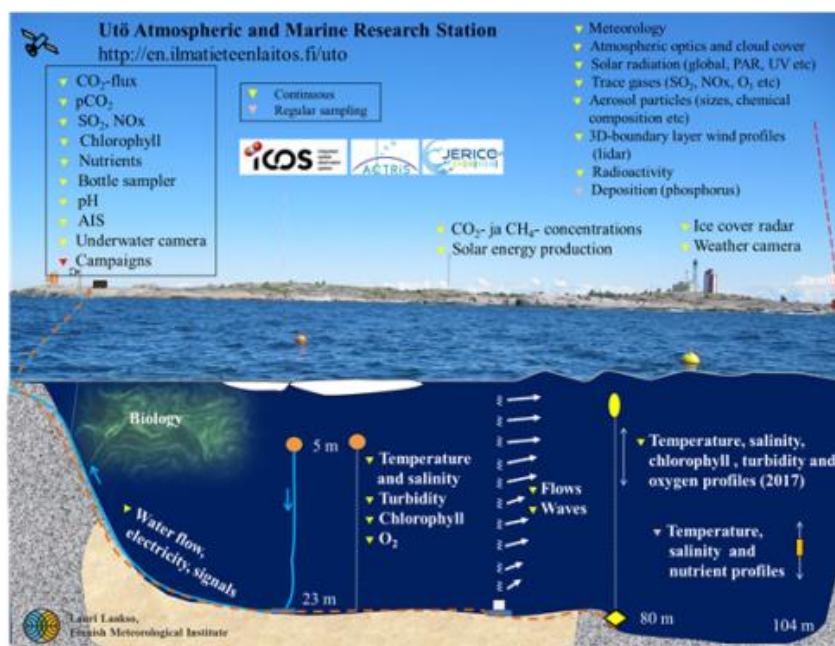

Figure 14. The Utö Atmospheric and Marine Research Station.

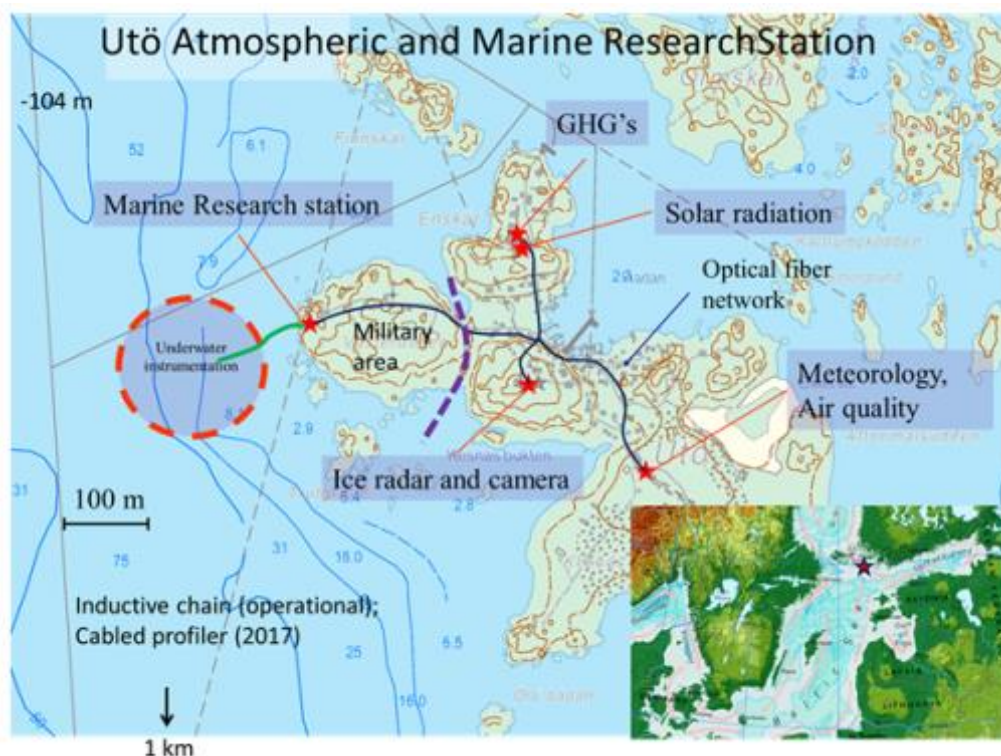

Figure 15. Map of Utö Island; insert: location of Utö in the Baltic Sea.

4.1.4 MOLENE

Maximal operating depth

Rated for 4000 m (actual depth: 20m).

Nominal distance from the coast (Molene-Node)

2 Km.

Remote control of the instruments and data recovery

Each instrument is provided with a virtual computer, accessible via internet, in order to run driver and store data.

Network throughput

1 Gbit; data are transmitted to the subscriber by a land-based server.

Data time stamping

GPS clock, NTP/PTP Network, Network Attached Storage.

Instruments connections

Number of ports: 1 or several modules of 6 inputs (Subconn MCBH12M, Micro Bulkhead, 12 contacts).

Voltage

15 V and 48 V.

Effective rated power for the 6 connections

75 W at 15 V, 5 W at 48 V.



Throughput per port
100 Mbits.

Communication protocols
Ethernet and serial RS232, RS485 and RS422.

❖ **Site selection approvals:**

The choice of the site was a result of a compromise between the the following:

- scientific interest;
- power and Ethernet availability;
- transport and access, regular crossing from Brest;
- on-site availability of personnel.

❖ **Manufacturer**

For the very specific components: Cable, Orange Marine.
Electro-optical wet-mateable connector: ODI, despite cost and time of delivery

❖ **Environmental concerns (electromagnetic pollution and other territorial impacts)**

Marine protected area: Parc Marin d'Iroise.

Little impact as far as EMSO-Molene is concerned:

- small unit, hardly any equipment on the island, and cable just laid on the seafloor;
- the system behave like an artificial reef;
- social impact: additional activity on the island (hotel, transport, etc.).

❖ **Cable deployment**

No major difficulty, use of a small barge by Orange Marine cable ship specialists.

4.1.5 LoVe

❖ **Status of LoVe**

So far:

| | |
|---------------------------------------|---------------------|
| <i>Installed Land node:</i> | <i>August 2012</i> |
| <i>Deployed autonomous Lander:</i> | <i>January 2013</i> |
| <i>Deployed subsea infrastructure</i> | <i>June 2013</i> |
| <i>Deployed Sensor node</i> | <i>June 2013</i> |

To come:

| | |
|--------------------------------------|------------------|
| <i>Update existing sensor node</i> | <i>June 2016</i> |
| <i>Expand LoVe with 5 more nodes</i> | <i>June 2017</i> |

❖ **Site selection**

The site is an environmental "hotspot":

- narrow continental shelf;





JERICO-NEXT

- spawning area;
- migration route;
- sea mammals;
- economically important for fish and petroleum industries;
- scientific cruises with long time series 3-4 times/year.

Challenges:

- high fishery activity;
- contact with fishing gear;
- strong current;
- unstable sediments.

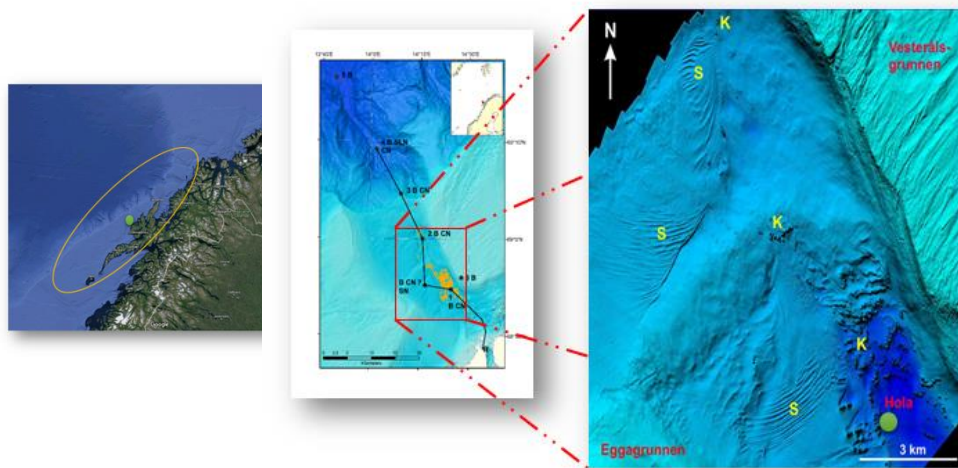

Figure 16. The LoVe observatory location, and deployment depth (256 m) of Node 1.

❖ Main sensors

Scientific Acoustics: Simrad EK-60, with horizontal and vertical transducers

The Simrad EK-60 is a “high end” split beam scientific echo sounder in the scientific market. Based on more than 60 years of research and development in close collaboration with leading marine scientists EK60 is established as the international standard for fish stock assessment.

The Simrad EK60 has been the obvious choice for modern research vessels and environmental monitoring installations requiring high quality scientific data for ecosystem studies and resource assessment and management. Operating frequencies span from 18 to 333 kHz with CW pulse type. The Simrad EK-60 acquisition SW operates on Microsoft Windows platform, with real time display through Internet and recording of RAW data in an open, documented format supported by various 3rd party post-processing software.



The EK80 is the successor of EK60. It is a modular system allowing various combinations of transducers and transceivers to achieve the best possible solution for

the user. It supports broadband operation with chirps giving a close to continuous bandwidth from 18 to 500 kHz,

Hydrophone

Ocean Sonics icListen has become a well-known Ethernet hydrophone used in several Ocean Observatories. The frequency span for the installed hydrophone, SB35-ETH, is rated to 3.500 m depth, covering the frequency range from 10 Hz to 200 kHz with a voltage sensitivity of -169 dBV re μPa

Camera

Metas DSF5210 High Resolution Deep Sea Camera has a High-sensitivity 18 Megapixel. The camera is designed for long-term deployment, with a housing in titanium and carbon fiber rated to 1.500 m depth (Standard Version)

All settings are controlled from shore via Ethernet via the infrastructure's cable.

Flash

Metas DSF 4365 Flash is designed for long-term deployment, with a housing in titanium and carbon fiber rated to 1.500 m depth (Standard Version). The flash is triggered directly by the camera.

❖ **Impact**

Coral reefs;

❖ **Infrastructure Cable**

Manufacturer

Nexans (price: 61000 €/Km).

Cable characteristics:

- 3 kV AC, 1 phase;
- 18 optical fibers, SM;
- TCP/IP;
- \varnothing 42.5 mm;
- Breaking Strength: 500 kN;
- Copper: 10 mm²;
- Weight in water: 3 Kg/m;
- Minimum bend radius: 0.7 m.



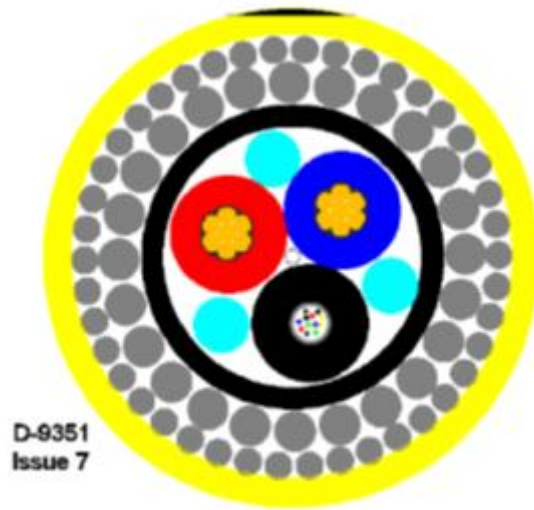

Figure 17. Section of the fiber and power cable.

❖ **Cable deployment**

Deployment Challenges

- Avoid coral reefs.
- High current – up to 1.5 m/sec.
- Cable route discussed with local fishery organizations, and changed to reduce conflicts with fishing equipment.

4.1.6 UNH

❖ **Site Selection Approvals**

- Must be relevant for the North Sea. Site should be in the proximity of different “typical” North Sea habitats/sediment provinces.
- Should be in close distance to the “long-term” measuring station “Helgoland Reede” where data are available since 1889 in a continuous time series.
- Should be easily accessible by divers for system management and maintenance.
- Should be in an area where many research groups work together already. Survey on research groups which are potentially interested in such a facility evidenced:
 - six research groups from the AWI;
 - three research groups from the HZG;
 - four external institutes.

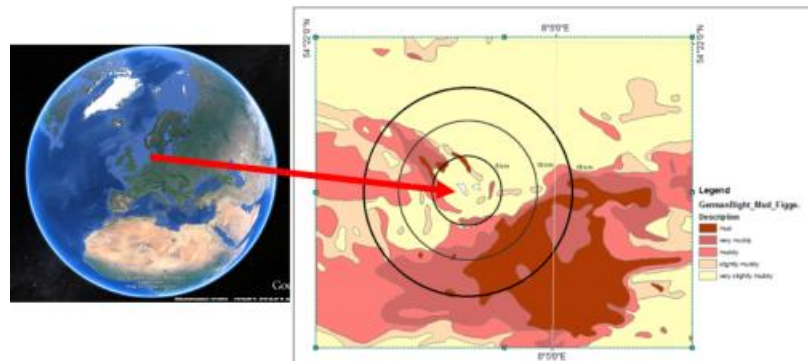

Figure 18. Site of the UNH observatory in the North Sea.



Figure 19. Underwater Node Helgoland location

❖ **Manufacturer**

The planned system was not available on the market. Therefore, cooperation in developing the system was sought from partners in industry (medium-sized enterprises). The following companies were:

- 4H-Jena, Jena, Germany, Hardware and Electronics;
- Loth Engineering, Wiesbaden, Germany, Software and Networking.

❖ **Environmental Concerns (electromagnetic, environmental concerns)**

- Following German environmental regulations, a professional environmental evaluation on the potential impact of the system was carried out by an environmental consultant. The impact of the system was deemed to be low in comparison to the expected knowledge gain.
- Applications for site approval had to be made to the German authorities for ship traffic and waterways. The site was approved, and is now marked as





an “exclusion zone for ship traffic” on the official sea charts of the German Bight.

❖ Infrastructure cable

Getting the right cable with respect to the price and the durability was a challenge. Offers were requested from three different companies. Finally, a heavy-duty, armoured (Kevlar) sea-cable with 6 separate power and three separate fiber-optic lines (priced at about 20000 €/Km) was used.

❖ Power

Because the node system was constructed for a potential operational range of 30 Km, a cable supplying 1000V DC is used as the main power supply. In the node system, this is converted to 48V. The system has an internal power supply (USV-48V) which permits switching off of the main power for about 5-8h during maintenance by divers.

❖ Communications

- Fiber-optic and TCP/IP communication for long-distance (>70m) communication (from the land station to the node).
- Cooper and TCP/IP communication for short-distance communication (< 70m) between the Node and the Lander/Sensors systems.
- Other communication protocols used to attach sensors to the Lander systems/Sensor carriers:RS232, 422, USB, etc.

4.1.7 UNS

❖ Site Selection Approvals

- Site must be relevant for the Arctic ocean.
- Site should be in the proximity of different “typical” Arctic habitats.
- Site should be in an area where many research groups are already working together.



Figure 20. Site of the UNS observatory, North Sea.



4.2 Main operational issues

Issues to be addressed: Power outages and communication failures, deployment of new instruments, cabling and connectors, and security.

4.2.1 OBSEA

❖ Power outages and communication failures

The OBSEA team has had experience with power outages due to many different reasons. The main ones encountered thus far have been a submarine cable break caused by exposure to extreme conditions, a junction box inundation caused by the water pressure and the theft of a land cable. From the standpoint of communication failures, a fibre-optic cable was once destroyed by rats.



Figure 21. Destruction of optical fiber eaten by rats.

❖ Deployment of new instruments

The procedure for deploying new instruments in OBSEA is the following:

- design and construction of a cable adaptor;
- test in the OBSEA network;
- test in a hyperbaric chamber;
- data integration with the OBSEA database, if required.

❖ Cabling and connectors



Figure 22. GISMA Series 10, size 3 underwater connectors.

The OBSEA standard connector is the GISMA Series 10, size 3 connector. Seacon MCIL8F / MCBH8M connectors are used for custom instruments.





❖ Security

Regarding security, the installation process in this observatory was partially covered by UPC's university insurance policy. At the beginning, all the instruments were deployed inside a screwed cage to minimize unauthorized manipulation. Now, however, they are deployed by attaching them to the cage to allow easy access.

4.2.2 CPO

❖ Power outages and communication failures

The system went down three times during the commissioning phase; although there is a UPS in place, problems in the Power Feed Equipment led to these outages. This issue has been solved by the manufacturer.

❖ Cabling and connectors

The observatory has no underwater mateable connectors installed yet, meaning that there is no possibility of installing new instruments or failed instruments without lifting the underwater node. All instruments and cables to be deployed are tested in a workbench replica of the underwater node prior to deployment.

❖ Security

The test site has been equipped with a surveillance camera based onshore, and an AIS receiver will be installed shortly.

4.2.3 UTÖ

The Utö station is mostly operational at the moment, but during the first years the following challenges were encountered.

- Biofouling, which is an issue with all underwater instruments. In some cases, this was resolved partially by pumping water to the coastal station and using the instruments inside a measurement station, where cleaning and maintenance is easy, instead of deploying them directly in the sea.
- Lightning could be a challenge with long signal cables: during the installation phase, some instruments were damaged before the relevant safeguards could be installed.
- Corrosion is a constant threat for both structural elements and instruments. Most instruments are made of acid-proof steel. Despite zinc anodes, corrosion especially crevice corrosion, cannot easily be stopped.
- Planning the maintenance of underwater instruments has proven both difficult and expensive as the site is far out at sea, and weather often can prevent diving operations for up to several weeks.





4.2.4 MOLENE

❖ Power outages and communication failures

The following situations were faced.

- The server reached its safety temperature limit setting: the temperature in the container arose because the air conditioner did not operate when the temperature outside was lower than 18°C.
- A major power loss occurred due to the destruction of the outdoor power equipment during a particularly heavy and long storm. It took some time to fix the system. The area is protected by rocks but divers have to go quite a long way to cross.
- Despite a warning to mariners, the cable was brought to the surface by seaweed gatherers in the area, but without causing it any damage so no power outage resulted.

❖ Deployment of new instruments, cabling and connectors

As permanent equipment

A dissolved oxygen sensor, a CTD and a turbidity sensor.

As temporary test

An OBS was deployed in the field of the camera to help interpret seismic data acquired in the Marmara Sea.

4.2.5 LoVe

❖ Subsea Distribution Unit

Power distribution and communication with Node:

- transforms power from 3 kV AC to 220 Volt AC;
- less challenging regarding connectors;
- oil-filled;
- pressure compensated;
- designed for 25+ years.

Wet mateable connectors:

- for power: Tronic;
- for fibre-optics: Seacon Hydralight.





❖ Land station

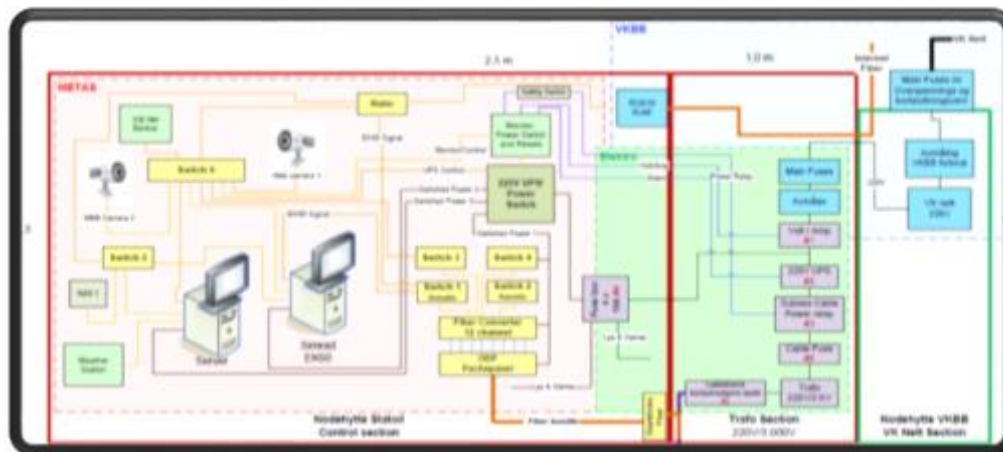

Figure 23. An overview of the LoVe Network.

❖ Sensors installed in Node 1

| Instrument | Brand | Type | Spec |
|---------------------|--------|-------------|--|
| Scientific Sounder | Simrad | EK60 | Frequency: 70 kHz Splitbeam |
| | | | Pulse length: 64 - 2.048 μ s |
| | | | TX Power: 100 W - 1000 W |
| Sounder Transducers | Simrad | ES70-CD | Transducer: Composit |
| | | | Frequency: 70 kHz Splitbeam |
| | | | Transducer beam: 7.0° |
| | | | Side lobes: < -23 dB |
| | | | TX response: 185 dB re 1 μ Pa per V |
| | | | RX Sensitivity: -190 dB re 1V per μ Pa |
| ADCP Long Range | Nortek | Continental | Depth rating: 1500 meters |
| | | | Frequency: 193.5 kHz |
| | | | Beams: 3 beams, slanted at 25° |
| | | | Beam with: 3.0° |
| | | | Max profiling range: 30 - 40 m |
| | | | Cell size: 1 - 4 mm |
| | | | Max # of cells: 128 |
| | | | Accuracy: 1% of measured value |
| ADCP short range | Nortek | Aquadop | Velocity resolution: 0.1 cm/s |
| | | | Frequency: 0.6 MHz |
| | | | Beams: 3 beams, slanted at 25° |
| | | | Beam with: 3.0° |
| | | | Cell size: 1 - 4 m |



JERICO-NEXT

| | | | |
|-----------------------------|-------------|------------------------|--|
| | | | Max # of cells: 128 |
| | | | Accuracy: 1% of measured value \pm 0.5 cm/s |
| Still Camera | METAS | DSF5210 | Size : Ø220 x 336 mm (D x h) |
| | | | Material : Titanium GR2/Carbonfiber |
| | | | Sealing: Dual, Radial and Axial |
| | | | Depth rating: 150 Bar |
| | | | Weight in air: 12.2 Kg |
| | | | Weight in water: -0.6 Kg |
| | | | Camera module: Canon EOS 550 |
| | | | High-sensitivity: 18 Megapixel CCD |
| | | | ISO: 80 - 6400 |
| | | | Lens: 18-55 mm wide-angle zoom lens. f: 3.5 - 5.6 |
| | | | Mission plan: Setup via Web interface. |
| | | | Memory Card: 16 GB memory card (SD) for internal rec. |
| | | | Downloading pictures: USB interface |
| | | | Image recording: RAW or jpeg |
| Camera Flash | METAS | DSF4365 | Size : 120 x 275mm (d x h) |
| | | | Material : Titanium GR2/Carbon fiber |
| | | | Sealing: Dual, Radial and Axial |
| | | | Depth rate: 150 Bar |
| | | | Interface: Camera trigger cable |
| | | | Connector: MB2-8 |
| | | | Max guide number: 58 (at ISO 100, 105 mm zoom setting) |
| | | | Maximum view angle: 14 mm |
| Flash mode: manual or E-TTL | | | |
| Hydrophone: | Ocean Sonic | SB35 ETH | Frequency range: 10 Hz - 200 kHz |
| | | | Peak measured signal: 175 dB re.1 μ Pa |
| | | | Noise: 30 dB re. 1 μ Pa ² /Hz at 10 kHz |
| | | | Sensitivity: -171 dBV re. 1 μ Pa with pre-amp |
| | | | Material: Titanium GR2 |
| | | | Depth rate: 300 Bar |
| Particle sensor dynamic | WetLabs | ECO Triplet | Scattering wavelengths: 470, 532, 650 or 700 nm |
| | | | Range, typical: 0 - 5 m |
| | | | Sensitivity: 0.003m |
| Chlorophyll | Seapoint | Clorophyll Fluorometer | Output Time Constant: 0.1 sec. |
| | | | Excitation Wavelength: 470 nm CWL, 30 nm FWHM |
| | | | Emission Wavelength: 685 nm CWL, 30 nm FWHM |
| | | | Sensing Volume: 340 mm ³ |
| | | | Minimum Detectable Level: 0.02 μ g/l |
| | | | Gain setting: 1X |
| | | | Sensitivity setting: 0.033 v/(μ g/l) |
| | | | Range setting: 150 μ g/l) |
| Depth capability: 6000 m | | | |



JERICO-NEXT

| | | | |
|----------------------------------|------|-------|---------------------------------------|
| Turbidity | AADI | 4112A | Gain: 20X |
| | | | Range: 0 - 125 FTU |
| | | | Sensitivity: 40 mV/FTU |
| | | | RMS Noise: < 1 mV |
| | | | Light source wavelength: 800 nm |
| | | | Sensing distance: < 5 cm from window |
| | | | Linearity: < 2% deviation 0 - 750 FTU |
| | | | Temperature coefficient: <0.05% pr °C |
| Pressure | AADI | 4117D | <u>Pressure:</u> |
| | | | Range: 0 - 20000 kPa (0 - 2900 psia) |
| | | | Resolution: <0.0001% FSO |
| | | | Accuracy: ±0.04% FSO |
| | | | <u>Temperature:</u> |
| | | | Range: 0 - 36°C (32 - 96.8°F) |
| | | | Resolution: <0.001°C (0.0018°F) |
| | | | Accuracy: ±0.1°C (0.18°F) |
| Response Time (63%): <10 seconds | | | |
| Conductivity | AADI | 4319A | <u>Conductivity:</u> |
| | | | Range: 0 - 7.5S/m |
| | | | Resolution: 0.0002S/m |
| | | | Accuracy: ±0.005S/m |
| | | | Response Time (90%): <3s 1) |
| | | | <u>Temperature:</u> |
| | | | Range: -5 - 40°C (23 - 104°F)2) |
| | | | Resolution: 0.01°C (0.018°F) |
| Accuracy: ±0.1°C (0.18°F) | | | |
| Response Time (63%): <10 seconds | | | |

T

Table 8. Sensors installed in Node 1 of the LoVe Observatory.

❖ **Deployment of new instruments**

- X-Frame used as sensor carrier.
- Retrieve X-Frame and deploy again with maintained/new sensors.
- Today, a ROV is needed.
- Node 1 updated in June to new system for retrieval and deployment at maintenance without the use of a ROV.

❖ **Connectors**

Sensor used in Ocean observatories should be considered as “Long-term deployed”. Earlier experience has shown that the standard subsea connector is not suitable for long-term deployments. It is not so critical if used on single sensors, because then only one





sensor may fail. But if used in an interface unit, data from all connected sensors can be lost.

❖ Security

It is important to have a power management system where power to each sensor can be switched off individually:

- to prevent galvanic corrosion in case a sensor or a connector is leaking;
- to reset sensors by switching off power to the sensor, without shutting down the whole network.

❖ Technology

Interface unit

- Carbon fibre tube with titanium flanges and endcaps.
- Depth rating: 1500 m.
- Interface:
 - Ethernet with POE;
 - RS232/422+ power (Ethernet converter inside).

Acoustics

- Splitbeam technology.
- Carbon fiber container with Titanium flanges and endcaps.
- Depth rating: 1500 m.
- Computer inside for data management and sensor control.
- motor-controlled tilt training unit for transducers.

❖ Power supply

- Two UPS installed in the land station, able to keep the Observatory running for half-an-hour:
 - one for necessary equipment at the land station;
 - one for the infrastructure cable (for installed sensors).
- For backup, a generator could have been installed at the land station for charging the batteries in the UPS in case of loss of power.
- Compensation coils to be installed in the powerline in each Node (distribution unit) to reduce charging current in the infrastructure cable:
 - the 18 Km cable is draining 5 A without anything connected.

❖ Power security

- In case of loss of power, and if power is absent for more than 15 minutes, a watchdog system at the land station is performing a controlled shutdown of computers in the Observatory, including the computers in the nodes. All instrument and computers installed in the Observatory should survive loss of power without being damaged.
- Alarm triggered at the office.





- Manual startup of sensors after power failure.

❖ Reduction of interference from noise

The Scientific sounders are sensitive, measuring signal levels down to -120 dB. To keep interference to a minimum from other installed sensors, a shielded subsea cable is used between sensors and the interface, and motors are programmed to run in predefined timeslots

4.2.6 UNH

❖ Power outages and communication failures

The system is operated with 1000 VDC and is shut down during maintenance by divers. It can be operated in USV mode for at least 3-4 hours with 48 V (German/EU safety regulations allow 60 V DC when divers are operating on the system).

❖ Deployment of new instruments

- Deployment of new sensors is done by divers according to a strict procedure.
- System has to pass a test-run in the lab for demonstrating the general functionality of the hardware and software.
- System has to pass a test-run in an indoor test basin (3 m deep, floor dimension: 3 m x 3 m) for 24h.
- Depending on the complexity of the instruments, the deployment can take anywhere from a few hours to days.



Figure 24. Deployment of new underwater elements with the ship crane.

❖ Cabling and connectors

- *Long-distance*: Power/fiber-optic, armoured (Kevlar) underwater cable Kevlar.
- *Short distance*: Subconn hybrid Network/Power cables (max. 70 m).





- *Sensor connection:* Depending on the sensor manufacturer. Required cables are produced (configured) inhouse .

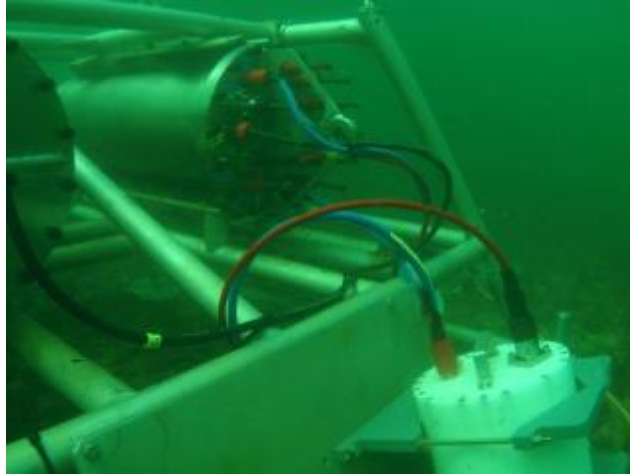

Figure 25. Connection between UNH node and instruments.

❖ Specific procedures for cables and plugs

- Male connectors at fixed installations under water.
- Female connectors for the (removable!) cables.
- Proper greasing is mandatory for proper functioning of the plugs.
- It is absolutely mandatory to use the proper grease before wet-mating the plugs.
- Without or with the wrong grease, the average lifetime of the 1000 V plugs was about 3 month and that of the 48 V plugs was about 6 - 8 months. Using the proper grease, there have been no problems with plugs since about 2.5 years.
- It is recommended to use proper cable “fasteners” to prevent current- induced movements of the plug units.
- Based on experience, in shallow water observatories where the maintenance and installation of sensors or components is done by divers, the use of SUBCONN or similar (cheap) connectors is possible. For long-term exposure and ROV handling, GISMA-like plugs seem to be a better choice.

4.2.7 UNS

- The system parts and the sensors must work for 9 month at least without any physical access; companies/colleagues underestimate the operational difficulties due to restricted access, lack of proper spare part supply, and the limited time available on-site.
- The controlling hardware and software (server, etc.) must be fully remote controllable, and must include reliable redundancies (all server systems at AWIPEV are redundant).
- The system is designed to reduce the chance of being destroyed by an iceberg collision; collisions have occurred 4 times since 2012.





❖ Security

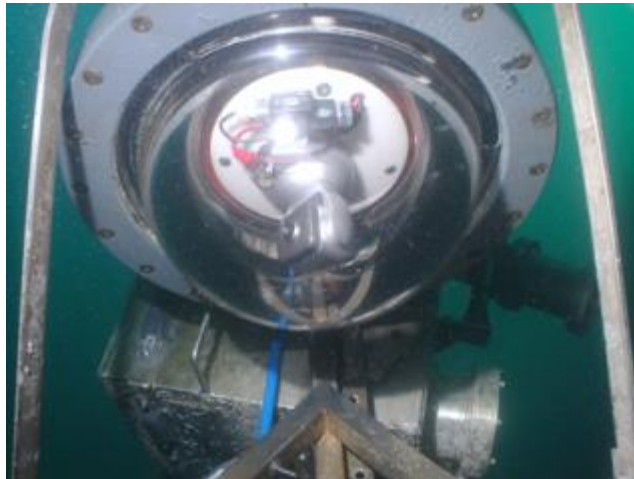

Figure 26. UNS underwater webcam system used to monitor the area.

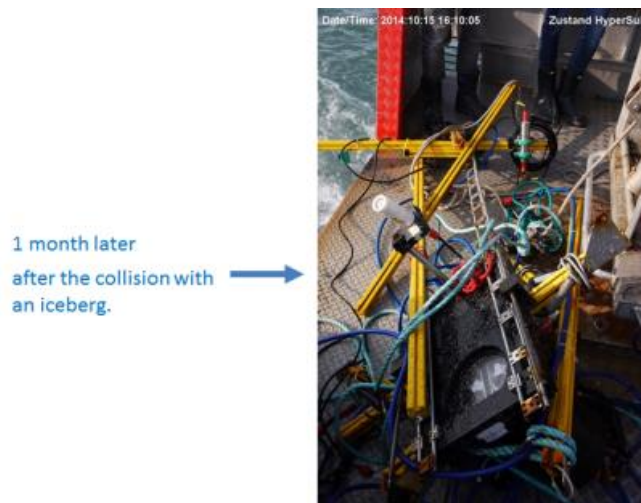

Figure 27. Equipment damaged after one month under the sea.

The possibility of losing equipment is taken into account. A surveillance system via surface and underwater webcams is present. The area is continuously monitored for drifting icebergs, especially in spring.

4.3 Site maintenance

Issues to be addressed: Schedule, tasks, etc.





4.3.1 OBSEA

The servicing schedule of this group contemplates one dive per month in order to guarantee the maintenance of every instrument according to its fouling sensitivity. Nevertheless, it is possible to increase this frequency when a new deployment or some extra maintenance action is. The following tasks are carried out during the routine monthly dives:

- cleaning of the camera;
- visual inspection of the hydrophone, CTD, ADCP, and seismometer;
- inspection of the sacrificial anodes;
- inspection of the buoy chains and anchors.

4.3.2 CPO

In terms of maintenance, the underwater node is planned to be lifted at least once a year. Less frequent haul-up operations are envisaged once sufficient knowledge on fouling and operational conditions is gathered, and specialized equipment has been installed to prevent to permit this reduction.

There will be periodic visits by divers to clean camera and instruments (once every two months, weather permitting) and, in the future, also the eventual installation of other instruments.

The first major node lift is planned for late 2016, with the following operations scheduled to take place:

- installation of underwater lights;
- replacement of instruments that need calibration/service;
- installation of anti-fouling system for the camera;
- installation of UMEC and spare electrical cables.

4.3.3 UTÖ

At Utö, site maintenance is relatively easy (except for underwater work requiring divers). The maintenance operations have been organized in the following ways.

- FMI has one employee living on the island, so weekly instrument maintenance is always available. It is also possible to call this person if something unusual happens.
- All data from the site is sent to the FMI server, where it is visualized. The data is checked several times per week
- Data logging programs are able to identify some error situations, e.g. wrong flows, temperatures, leaks and pressure errors.
- SOPs (Standard Operating Procedures) have been established for all instruments. These are used to make sure all service operations are always done using the same methods and protocols.
- All procedures at the site are documented in an electronic diary, which is available in real-time and online.





- All safety issues are documented in a 25-page occupational health document, which covers risk assessment and safe working practices. Occupational safety devices (life jackets, personal flotation devices, safety goggles, fire extinguishers, first aid kits, defibrillator, eye cleaning liquids, etc.) are regularly checked.
- All electrical installations are planned in a safe way, so that scientists do not risk electrical shocks.
- All chemicals are used and stored in a fume cupboard.

4.3.4 MOLENE

- Visual inspection and cleaning: Every 3 months.
- Swapping components: every 6 months or when required, difficult during winter.

4.3.5 LoVe

Metas has a maintenance contract for the LoVe Observatory until it will be officially taken over by IMR in 2017.

- Initial deployment of the Observatory: June 2013.
- First maintenance of the Observatory: June 2014.
- Next maintenance of the Observatory: June 2016.



Figure 28. LoVe maintenance tasks.

The operations performed during the first maintenance were:
haul to land for maintenance;

- clean all parts externally;
- open all containers for check;
- check equipment and sensors;
- change sacrificial anodes;
- calibrate sensors;





JERICO-NEXT

- add new sensors;
- re-deployment using a vessel of opportunity.

The maintenance operations in June 2016 were:

- recovery onboard R/V G O Sars;
- clean all parts externally;
- check equipment and sensors;
- change sacrificial anodes;
- calibrate sensors;
- add Stereo Camera Satellite;
- install docking station on the seabed;
- re-deployment using new deployment tool.

❖ Biofouling experience

Sensors emitting light

Seaweed growth on light source: added mission plan for running sensors in time-lapse.

Camera lenses

Small shell growing on protective glass: change of material in glass holder ring from titanium to JM7 metal.

❖ Remote management

All sensors can be reached online from the office via Internet.

4.3.6 UNH

Node Helgoland is situated in the main underwater experimental zone “MarGate”, about 400 m north of Helgoland. Daily access to the node is possible within 30 minutes, if necessary. The “Center for Scientific Diving/In situ ecology” Working Group of the UNH is made up of about 12 members (post-docs, PhD students, and Master- and Bachelor-level students). All are divers and do field work, so site maintenance is done as a side job, though there are many other projects requiring diver support in the same area.

4.3.7 UNS

Node Spitzbergen is situated about 150 m in front of the so-called “Old Pier” in one of the main research areas in Spitzbergen. The maintenance of the Node is organized as follows:

- Two 3-week expeditions per year with divers (spring and autumn) for maintenance and sensor installation;
- Emergency expeditions in case of system failure (2 times since 2012);
- Extensive test procedures of new sensors in Germany prior to a deployment;
- System configurations for the Helgoland and Spitzbergen nodes is identical; Sensors which are tested and configured for the Helgoland node work equally well in Spitzbergen.





4.4 Quality assessment

Issues to be addressed: Automatic reporting on changes in status of stations and computer systems, web-based database of incidents and actions, etc.

4.4.1 OBSEA

OBSEA has not yet fully implemented an automatic reporting system for changes in the status of stations and computer systems. However, all instrument port operations are logged, and the general status is monitored, with a web-based software called Zabbix. Received data are visually inspected. Some of the instruments incorporate very elementary data quality control.

| Monitores | Alimentación | CPU0 CPU | CPU0 Mem | CPU0 SW | Labeler | Liama | Mapa de Mesa Frontal M300 | PC_Mesa | Shapel | Zabbix_Mesa |
|---------------------------------|--------------|-----------------|----------------|-----------------|---------|-------|---------------------------------|---------|--------|-------------|
| Average disk read queue length | -- | -- | -- | -- | -- | -- | -- | 0 | -- | -- |
| Average disk write queue length | -- | -- | -- | -- | -- | -- | -- | 0 | -- | -- |
| Buffers memory | -- | -- | -- | -- | -- | -- | -- | -- | -- | 212.73 MB |
| Bytes de salida | -- | 1.67 GBytes | 6.58 MBytes | 1.89 GBytes | -- | -- | -- | -- | -- | -- |
| Bytes entrada | -- | 2.75 GBytes | 1.87 MBytes | 2.25 GBytes | -- | -- | -- | -- | -- | -- |
| Bytes/s de entrada Interfaz 1 | -- | 287.80 Bytes/s | 828.10 Bytes/s | 0 Bytes/s | -- | -- | -- | -- | -- | -- |
| Bytes/s de entrada Interfaz 10 | -- | 0 Bytes/s | 0 Bytes/s | 0 Bytes/s | -- | -- | -- | -- | -- | -- |
| Bytes/s de entrada Interfaz 11 | -- | 0 Bytes/s | 0 Bytes/s | 343.90 Bytes/s | -- | -- | -- | -- | -- | -- |
| Bytes/s de entrada Interfaz 12 | -- | 0 Bytes/s | 474 Bytes/s | 541.07 KBytes/s | -- | -- | -- | -- | -- | -- |
| Bytes/s de entrada Interfaz 2 | -- | 7.35 KBytes/s | 0 Bytes/s | 0 Bytes/s | -- | -- | -- | -- | -- | -- |
| Bytes/s de entrada Interfaz 3 | -- | 5.11 KBytes/s | 162.70 Bytes/s | 0 Bytes/s | -- | -- | -- | -- | -- | -- |
| Bytes/s de entrada Interfaz 4 | -- | 0 Bytes/s | 49.56 Bytes/s | 0 Bytes/s | -- | -- | -- | -- | -- | -- |
| Bytes/s de entrada Interfaz 5 | -- | 2.45 KBytes/s | 0 Bytes/s | 0 Bytes/s | -- | -- | -- | -- | -- | -- |
| Bytes/s de entrada Interfaz 6 | -- | 0 Bytes/s | 0 Bytes/s | 0 Bytes/s | -- | -- | -- | -- | -- | -- |
| Bytes/s de entrada Interfaz 7 | -- | 0 Bytes/s | 0 Bytes/s | 0 Bytes/s | -- | -- | -- | -- | -- | -- |
| Bytes/s de entrada Interfaz 8 | -- | 0 Bytes/s | 0 Bytes/s | 0 Bytes/s | -- | -- | -- | -- | -- | -- |
| Bytes/s de entrada Interfaz 9 | -- | 171.54 KBytes/s | 0 Bytes/s | 10.79 KBytes/s | -- | -- | -- | -- | -- | -- |
| Bytes/s de salida Interfaz 1 | -- | 717.11 Bytes/s | 505.10 Bytes/s | 0 Bytes/s | -- | -- | -- | -- | -- | -- |

Figure 29. A snapshot of part of the Zabbix listing, showing the status of different instrument port operations.

4.4.2 CPO

The status of the Observatory is continuously monitored via a NMS that allows:

- Automatic recording of events;
- Automatic generation of alerts.

The events database of the NMS is kept in its own server at the shore station, powered by a UPS; therefore, it is possible to determine the conditions of the Observatory's equipment right up to the moment of failure. The status of deployed equipment is regularly checked as well (manually, during business hours). Scientific data collected by the Observatory is also monitored periodically, and run through QC procedures at the Marine Institute.

4.3.3 UTÖ

Weekly maintenance is performed utilizing the SOPs mentioned earlier, and an electronic diary documenting all actions taken is kept updated. The latter also acts as an "institutional memory" for the station.



Currently, the following data QC protocols are in place. In a first stage, data visualization programs are automatically plotting received data. To support quality assurance, many additional sensors observing process variables like water flows, voltages and positions of valves, system temperatures and pressures, etc. have also been integrated. Some parameters (like $p\text{CO}_2$) are being measured with multiple devices, in order to analyze potential problems in the instruments themselves as well as for developing “instrument functions” for different measurement setups, for e.g. a flow-through system.

The QAQC is far from complete, and is being continuously improved.

4.4.5 LoVe

Reporting and database:

- still in development;
- to be completed before deployment of the next 5 nodes.

4.4.6 UNH

- Automatic reporting of changes in the status of stations and computers, and a multi-level reporting system.
- Web-based Node configuration (operations managed by the node steering group) to:
 - switch power and network on/off;
 - configure ports;
 - control the functioning of systems;
 - error reporting in case of system change (power down, network failure, transmission rate failure etc.).
- Web-based protocol for maintenance work (operations managed by the dive group in cooperation with the node steering group):
 - planning (e.g. which sensors are installed where, when was the last cleaning/maintenance etc.).
- Control system for data availability based on e-mails:
 - check every 60 min if data files for the different sensors are available and of correct size;
 - report errors in case a sensor is not online or no data are available.
- Wiki with all specific information on the node systems:
 - node specifications;
 - sensor configuration;
 - all information which are not assessed by the other reporting systems (electric drawings, sensors available in the entire project, etc.).
- *Under development*: a single web-based COSYNA reporting and information system integrating the above-mentioned wiki and a second separate reporting and information system.

4.5 Data management





Issues to be addressed: data formats; Quality Control, data processing, and data flow for dissemination.

4.5.1 OBSEA

❖ Format

Instruments have been categorized into the following three groups when considering data formats.

Low rate instruments (e.g. a CTD)

A Serial/Ethernet converter is employed. Data is transmitted via UPD packets. Then, a custom software program in the server receives, decodes and inserts the data in the database. Interoperability protocols like Puck are being developed.

High rate instruments (e.g. a hydrophone)

Here, the data is redirected to users.

Instruments with proprietary communication protocols (e.g. AWAC)

With these instruments, the data is received using manufacturer-provided software, and stored in files. Then, an in-house software program is developed to parse these files and insert the data in the DB.

❖ Quality control

Data is monitored using the Zabbix open software, which allows the integration of oceanographic and engineering data.

Graphical views of data can be easily configured, and a system of alarms has been developed to account for aberrant conditions, for e.g. data out-of-range, no data, etc. In addition, quality control algorithms are being implemented for data transmitted to external data collectors.

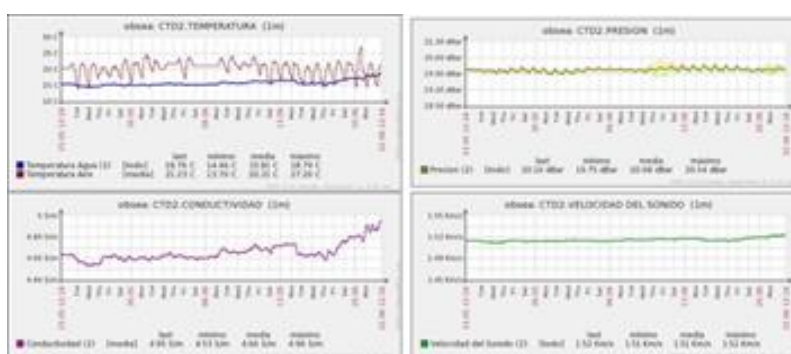

Figure 30. Example of web-based charts of one year of data for different variables, as monitored using Zabbix.





❖ Data processing

Data is stored in a database. There are custom web-based retrieval tools available for analysing the data. Some specific types of data are processed by external groups. A few examples are given below:

- sound detection data at LAB (Bioacoustics Laboratory);
- fish count data at ICM from CSIC (Marine Sciences Institute);
- sediment movement data at ICM from CSIC.

❖ Data flow for dissemination

OBSEA data is also automatically transmitted to some clients, for example:

- hydrophone data -> LAB;
- images and currents -> ICM;
- CTD and meteorological data -> SOS;
- meteorological data -> Meteoclimàtic.

4.5.2 CPO

This is still an on-going task, but the following has been achieved.

- Data collected “continuously” from instruments (i.e., at high sampling rates) in an automatic fashion.
- Data is not converted to any standard common format, but kept “raw” in the native instrument format; no quality control performed yet.
- Timestamp applied to data from equipment without RTC.
- Data stored in a fileserver; directories being made available in the net via FTP or HTTP.
- Metadata stored in SQLServer database.

4.5.3 UTÖ

All data from Utö is going to a central, back-upped server at FMI. It is stored in a pre-planned data structure, including also the necessary documents for the sampling methods. Part of the data is directly analyzed and plotted on the same server. The server is also built so that all data can be sent through ftp after automatic data quality checks. In the long-term, part of the data is automatically analyzed and corrected, and then used as part of FMI's operational services. This includes especially the data relevant for marine forecasting, like wave observations, underwater currents, regional ice cover, and vertical profiles of temperature and salinity. As soon as the data quality assurance procedures are good enough, most of the data will be distributed through the FMI open access data portal (<https://en.ilmatieteenlaitos.fi/open-data>) using Open Geospatial Consortium standards and following the recommendations of the EU INSPIRE Directive.

4.5.4 MOLENE



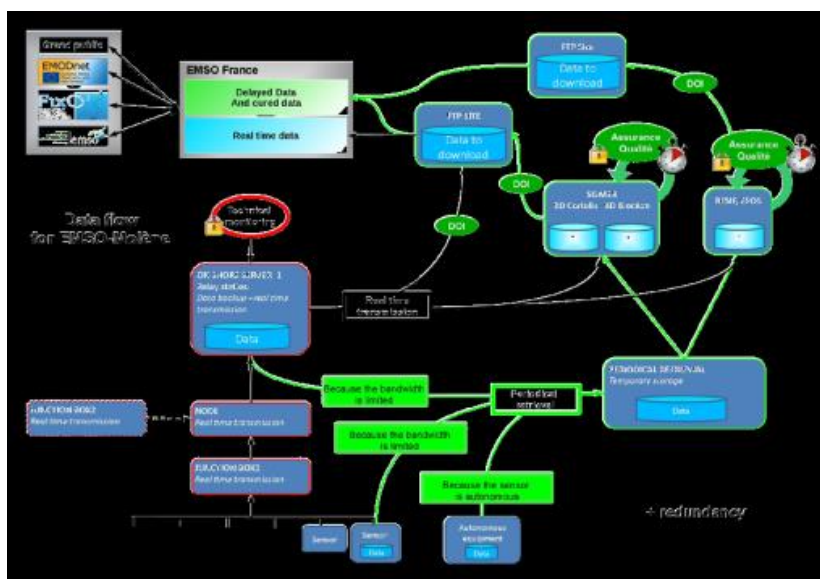

Figure 31. Data management system of the EMSO-Molène Observatory.

Data are available at “<http://www.emso-fr.org/>, Access to DOIs, Real time Data plot, sensor metadata”.

4.5.5 LoVe

Uploading of data to LoVe webpage:

- 20 min delay;
- 5 weeks delay on hydrophone.

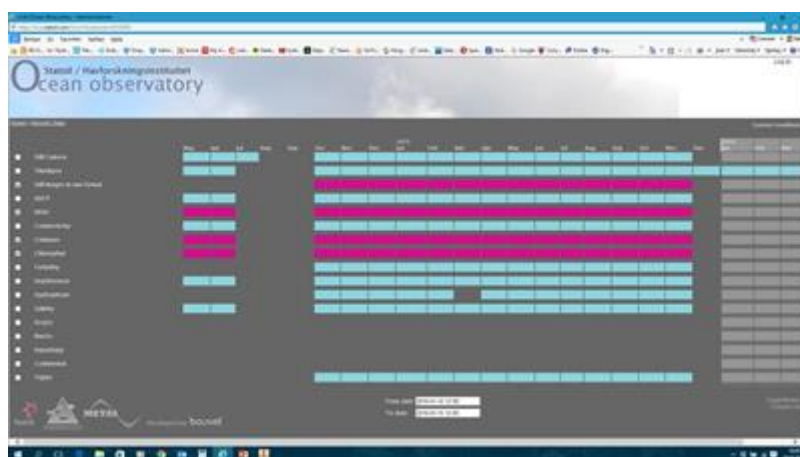

Figure 32. The data management status of the LoVe Observatory.

4.5.6 UNH



Two redundant philosophies.

- Helmholtz-Centre for Coastal Research (HZG):
 - specifically developed programs to extract data from the online dataflow of the sensors;
 - data are flagged as “good”, “probably good” and “bad” data according to basic check algorithms;
 - data can be downloaded (open access) as ASCII or netCDF data in the web-based data portal.

- Alfred-Wegener-Institute, Helmholtz-Centre for Polar and Marine Research (AWI):
 - programs from the manufacturer are used for the assessment of data from the sensors; the programs are controlled by a specific macro language, allowing to easily set up “user actions”;
 - data are saved “hourly” or “daily” as original sensor files readable by the program of the sensor or ASCII files with metadata;
 - data are processed with algorithms for accuracy and precision calculations (ongoing project -> TempEX Experiment at AWI);
 - data are provided with delays of half-a-day or 1 - 2 days (open access) through the AWI-NRT Database in the ASCII and JSON formats.

4.6 Applications

Issues to be addressed: Users and areas (research, engineering, fisheries, etc....).

4.6.1 OBSEA

Data provided by OBSEA is used by the LAB, ICM - CSIC, and others on demand, both in the research and engineering fields.

4.6.2 CPO

The following have been registered, or identified, as users of the observatory:

Irish researchers through National Infrastructure Access Program grants or other grants for specific research projects;

- Wave Energy Converter developers;
- general public (camera, visual feeds);
- data from standard set of instruments is made publicly available, supporting any suitable project;
- Irish state bodies, such as Inland Fisheries (fish tags detection project) or SEAI (through support to WEC developers);
- facility listed for Transnational Access.





4.6.3 UTÖ

UTÖ is working with many partners like the Finnish Traffic Agency, Finnpiilot Ltd, the Border Guard, Navy and several companies, which are using the observatory site as a testbed for their instrument development programmes. The facilities at Utö are available to international partners for their field studies.

4.6.4 MOLENE

For scientific purposes:

- ADCP (current and wave measurements);
- hydrophones (ambient noise and dolphin monitoring);
- camera (local species);
- multi-parameter probe;
- projects (e.g. BMB, JERICO).
- BJ and Node (mature technology for other coastal nodes);
- piezometer (preparation of a piece of equipment deployed on Ocean Neptune Canada);
- anti-fouling device;
- monitor the performances at sea of several “Mastodon” units before deployment.

4.6.5 LoVe

Users

- fishermen fishing in the local area;
- schools using picture and data in connection with education;
- the scientific community in Norway and abroad;
- FFI – Norwegian Defense Research Establishment;
- commercial companies who want to do tests at the site.

4.6.6 UNH

User profiles

- Cooperation partners: other institutes which attach their sensors to the system.
- Research: dataflow in post-processing mode is linked to research search portals and archives like PANGEA and MANIDA);
- Public and governmental agencies: data flow in operational mode is linked to institutional data bases.



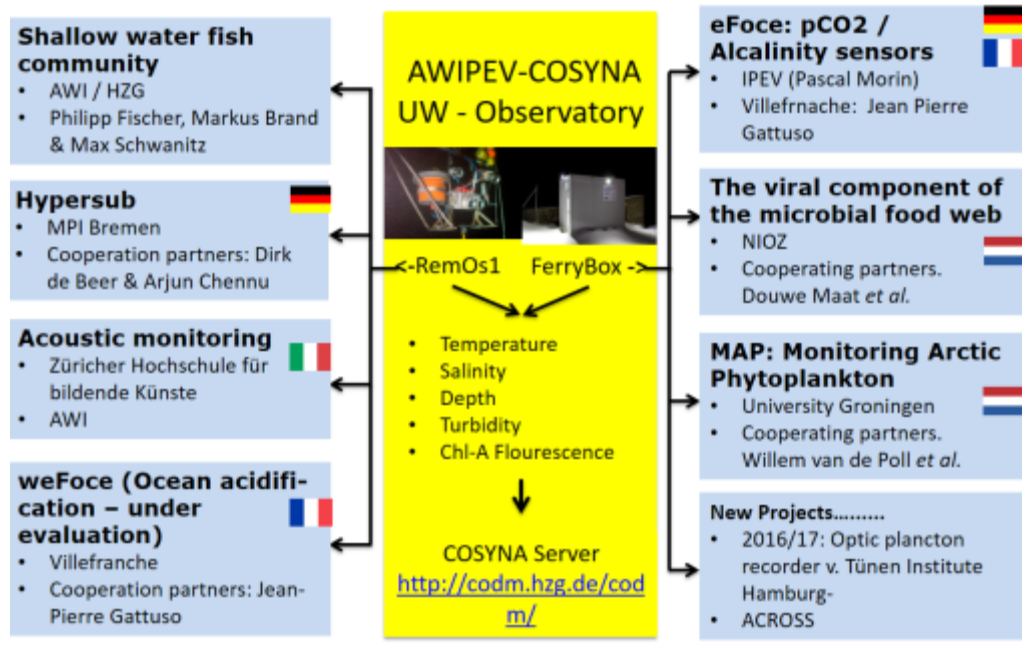

Figure 33. Applications and COSYNA data users.

4.7 Biofouling

4.7.1 OBSEA

- The camera is protected by a homemade wiper that is rated for one year. The Observatory staff is happy with it.
- The turbidity sensor is protected by a wiper that is rated for one year. The Observatory staff is happy with it.
- The ADCP sensor is protected by copper grease, and lasts for one year. The Observatory staff is happy with it.
- Biofouling protection for a tilting camera dome is under development using 3D printing technology. The system is based on a moving curved wiper that is driven by a magnet. The Observatory staff is moderately happy with it.
- The pH sensor is protected by a copper dome. The potential adverse effect of such protection has not been investigated. The Observatory staff is moderately happy with it.

4.7.2 CPO

- The ECO Wetlabs fluorometer is protected by the manufacturer's wiper and its copper cap.



- The camera is cleaned periodically by divers (twice in 6 months seems to be sufficient).

4.7.3 UTÖ

- Ferrybox flow-thru system are protected by TritonX.
- ADCPs are cleaned by divers twice a year.
- Wetlab CTDs are protected by the manufacturer's wiper and the copper cap. Observatory staff is moderately happy with it.
- Seabird probes are protected by the manufacturer's antifoulant devices.
- pCO₂ sensors are protected by copper in a pumped flow-thru device with added hydrogen peroxide.

4.7.4 MOLENE

- Sensors and oceanographic systems (camera, lights) are protected by the Ifremer electrolysis-based chlorination system.
- The element that is still problematic to protect is the camera dome.

4.7.5 LoVe

- The ECO Wetlabs fluorometer is protected by the manufacturer's wiper and its copper cap.
- The camera is cleaned periodically by divers (twice in 6 months seems to be sufficient).

4.7.6 UNH & UNS

- CTD, O₂, Chl-a and methane sensors are cleaned by divers periodically. The sensors are controlled against a reference CTD in situ during maintenance. For methane and Chl-a, waters samples are collected every 2 weeks and analyzed.
- The Wetlab underwater radiation sensor is protected by a wiper.
- The camera is protected by a homemade wiper (flat 20 cm window).

Corrosion protection

In addition to the classical sacrificial anodes, the utilization of anti-corrosive paint (NORSOK M501 7B, manufactured by International) was mentioned as a possibility to protect containers and casings from pit corrosion. The use of bolts in titanium has also been recommended.





5. Conclusions

The harmonization of technologies, methodologies and procedures is a vital step in ensuring efficiency and optimal returns from any kind of distributed, heterogeneous, multifaceted, coastal observing infrastructure operating on a transnational level such as the JERICO network. This is because such harmonization leads to an intelligent use of resources across the network, adds to the consistency of its services and products, and helps to provide uniformed access modes and interfaces to users.

The availability of two new observing technologies, HF Radars and Cabled Observatories, amongst JERICO-NEXT partners has been mapped. Furthermore, the current status of the relevant installations has been described and characterized with a view towards integrating them into the JERICO observing network. All this was done by holding the following two workshops:

- the HF-radar workshop, San Sebastian, Spain, 9-11 March 2016 (MS9-1);
- the Cabled Observatories workshop, Vilanova i la Geltrú, Portugal, 19-20 April 2016 (MS9-2).

The next step is to work towards greater harmonization of the different functional aspects of the two technologies within the network: the realization of installations, operational issues, quality assessment, data management, and applications. The objective is to reach some consensus on methods and practices. The results of this activity will be reported in Deliverable D2.4: *Report on Best Practice in the implementation and use of HF-radar systems and cabled coastal observatories*. Furthermore, common ground with the other technologies that were already addressed in the first JERICO project (Fixed platforms, Ferryboxes and Gliders) will be sought. Finally, it should be noted that the EuroGOOS observing platforms Task Team initiative could be a good tool to extend the scope and disseminate the outputs of this JERICO-NEXT action in Europe.

