

INTERGOVERNMENTAL OCEANOGRAPHIC
COMMISSION (OF UNESCO)



WORLD METEOROLOGICAL
ORGANIZATION



DATA BUOY COOPERATION PANEL

GUIDE TO MOORED BUOYS AND OTHER OCEAN DATA ACQUISITION SYSTEMS

by A. Meindl

DBCP Technical Document No. 8

**INTERGOVERNMENTAL OCEANOGRAPHIC
COMMISSION (OF UNESCO)**

**WORLD METEOROLOGICAL
ORGANIZATION**

DATA BUOY CO-OPERATION PANEL

**GUIDE TO MOORED BUOYS AND OTHER
OCEAN DATA ACQUISITION SYSTEMS**

DBCP Technical Document No. 8

1996

NOTES

The designations employed and the presentation of material in this publication do not imply the expression of any opinion whatsoever on the part of the Secretariats of the Intergovernmental Oceanographic Commission (of UNESCO), and the World Meteorological Organization concerning the legal status of any country, territory, city or area, or of its authorities, or concerning the delimitation of its frontiers or boundaries.

Editorial note: This publication is for the greater part an offset reproduction of typescripts submitted by the authors and has been produced without additional revision by the Secretariats.

CONTENTS

	page
CONTENTS	iii
FOREWORD	v
1. INTRODUCTION	1
2. MOORED BUOY HISTORICAL OVERVIEW	4
3. MOORED BUOYS	6
3.1 Hulls	6
3.1.1 Boat shaped	7
3.1.2 Toroid	7
3.1.3 Bumblebee	8
3.1.4 Discus	8
3.1.5 Semisubmersible	9
3.1.6 Other hulls	9
3.2 Moorings	9
3.2.1 Mooring line	11
3.2.2 Chain	12
3.2.3 Mooring assembly components	12
3.2.4 Anchors	12
3.3 Electronic payloads	13
3.4 Sensors	14
3.4.1 Anemometers	15
3.4.2 Barometers	16
3.4.3 Air temperature sensors	17
3.4.4 Sea-surface temperature sensors	17
3.4.5 Wave sensors	17
3.4.6 Subsurface sensors	18
3.4.7 Other sensors	20
3.5 Power systems	21
3.6 Deployment procedures	22
3.7 Refurbishment	23
3.8 International buoyage system and other requirements	23

	page
4. OTHER ODAS	24
4.1 Background	24
4.2 Types of station	24
4.2.1 Coastal	24
4.2.2 Offshore oil rigs	25
4.2.3 Island stations	25
4.2.4 Aid-to-Navigation (AtoN) buoys	25
5. DATA MANAGEMENT	26
5.1 Data flow	26
5.2 Shoreside processing	27
5.3 Quality control	27
6. CONCLUSIONS / RECOMMENDATIONS	29
FIGURES	31
 ANNEXES	
I. References	I-1
II. Member countries' buoy programmes	II-1
III. List of acronyms	III-1

F O R E W O R D

As noted by the author of this revised guide, E. A. Meindl, in his introduction, accurate marine forecasts (and indeed all meteorological forecasts) depend on a balanced, well-conceived marine observation network to provide data input to numerical models and operational forecasters. Elements of such a network include voluntary observing ships, satellites, radars, drifting and moored buoys and a variety of other ocean data acquisition systems (ODAS), and one of the objectives of the Operational WWW System Evaluation-North Atlantic (OWSE-NA) was to determine an appropriate and cost-effective mix of the different elements for that particular ocean basin.

Amongst these various marine observing system components, moored ocean buoys offer perhaps the only means of obtaining real-time, frequent, accurate, long-term observations of meteorological and oceanographic variables from a fixed deep-water location. As well as being invaluable for operational forecasting and the provision of services, such observations are also extremely important for climatological and research purposes.

A number of Members have recognized the value of moored ocean data buoys and have already established their own moored buoy programmes, while others are considering initiating such programmes. The Drifting Buoy Co-operation Panel (DBCP), at its second session (Geneva, October 1986), noted that there was a clear requirement for a technical document on the subject of moored buoys, which would both provide essential information for countries wishing to initiate a programme, as well as act as a means for sharing experiences amongst countries already active in the field. The DBCP therefore recommended that a Guide to Moored Buoys and other Ocean Data Acquisition Systems should be considered for preparation along the lines of the existing Guide to Drifting Data Buoys (IOC Manuals and Guides No. 20).

This recommendation was endorsed by the fifth session of the Joint IOC/WMO Committee for IGOSS (Paris, November 1988) and taken up by the tenth session of the Commission for Marine Meteorology (CMM) (Paris, February 1989), which nominated Dr G. D. Hamilton (USA) as rapporteur to undertake the preparation of such a guide. This original guide was published by WMO in 1990 as Reports on Marine Science Affairs No. 16 (WMO-No. 750). Subsequently, in 1995 the Data Buoy Cooperation Panel considered that this valuable guide should be updated in the light of recent technological developments. Mr E. Meindl (USA) offered to undertake this updating, and the present revised version of the guide while retaining portions of the first edition and including input from Members, is still largely the result of his own work. The sincere thanks of the DBCP, of WMO and IOC, are therefore extended to Mr Meindl for his very important contribution.

1. INTRODUCTION

Obtaining adequate marine environmental observations from the ocean areas of the world has long presented a serious problem. Observations of synoptic weather and sea conditions are considered sufficient only along major shipping routes.

Marine forecast accuracy will be optimized by a balanced, well-conceived observation network that can provide input to numerical models and operational forecasters. In addition to ship reports, observations in the offshore and coastal areas are provided by satellites, radars, buoys, and other Ocean Data Acquisition Systems (ODAS). Each observing system has strengths and weaknesses, and each tends to complement the others. All of the systems are valuable.

Ship observations are absolutely essential to the World Weather Watch (WWW), the World Climate Research Programme (WCRP), and other programmes. However, it is becoming increasingly difficult for individual ships' personnel (whose numbers are decreasing) to maintain meteorological observation schedules. Ship reports tend to be concentrated along shipping lanes, which leads to data-sparse areas outside these routes. The quality of ship observations varies considerably from ship to ship. This is probably caused by differences in individual instrument exposure, sensor maintenance, and differences in the level of training of personnel. Finally, ships tend to avoid areas of rough weather and seas, where observations usually are most needed.

Satellite imagery gives an unparalleled, broad view of weather patterns. Its utility, however, is dictated by satellite type and location of the weather with regard to the satellite position. Satellites with all-weather microwave instrument capability and the ability to provide global observations of many marine environmental parameters are becoming operational, but there will still be shortcomings in data coverage and timeliness.

Coastal radar is a very useful tool for detecting precipitation and severe weather approaching land. However, its value is limited by range and, in some places, by topography.

Drifting buoys have been found to be very effective in improving weather analysis and forecasting in data-sparse marine areas. They have been used extensively in research projects, such as the Tropical Ocean and Global Atmosphere (TOGA) programme. A key component of the World Ocean Circulation Experiment (WOCE), the Surface Velocity Profiler drifting buoy, played a vital role in studies of oceanic circulation. It has been out-fitted with a barometer (SVP-B), making it useful to atmospheric forecasting as well.

The use of drifting buoys is documented in a **Guide to Drifting Data Buoys** [33]. At its second session (Geneva, October 1986), the Drifting Buoy Co-operation Panel recommended that a companion **Guide to Moored Buoys and Other Ocean Data Acquisition Systems** be considered for preparation. In so doing, it recognized the important role that such platforms play in the acquisition of marine meteorological and oceanographic data and of the potential interest of a large number of countries in their deployment. This recommendation was endorsed by the fifth session of the Joint Intergovernmental Oceanographic Commission (IOC)/World Meteorological Organization (WMO) Committee for the Integrated Global Ocean Services System (IGOSS) (Paris, November 1988) and the tenth session of the WMO Commission for Marine Meteorology (CMM) (Paris, February 1989). As a result, this publication was produced originally in 1990 by Dr G.D. Hamilton (USA). At its eleventh session (Pretoria, October 1995), the Data Buoy Co-operation Panel (DBCP) (formerly the Drifting Buoy Co-operation Panel) recognized the need to update it.

WMO and IOC requirements for operational ocean station networks, including moored buoy and other ODAS, are clearly discussed in [4c]. Worldwide requirements are for a minimum of 75 anchored buoys outside the main shipping routes reporting sea-surface and air temperature, surface pressure and other data, four times a day. Establishment of about 100 additional conventional tide gauges is needed. Most of the existing requirements for subsurface data to be gathered within the framework of IGOSS come from WCRP requirements for such parameters. A number of Member countries have recognized the need for moored buoys and other ODAS and have established their own programmes. This rapporteur report is intended to inform present operators of the experience of different moored buoy and other ODAS programme managers, as well as to provide information for those planning to initiate such programmes.

Moored ocean buoys offer the only means of obtaining real-time, continuous, frequent, and accurate observations of marine conditions from the same deep-water location. Often, the first indications that forecasters have of rapid intensification or change in movement of storms come from buoys. In United States (US) coastal and offshore waters, approximately 50 per cent of all marine advisory warnings or actions are instigated by buoy reports or reports from automated platforms in coastal areas. On 9 November 1983, forecasters were first alerted to the rapid intensification of a storm off the north-west Pacific coast by observations of wind direction, wind speed, and barometric pressure from deep-ocean data buoys. Adequate clues were not initially recognizable from satellite data because this particular storm was at the edge of the useful image. Another severe storm, on 11-12 October 1984, resulted in the drowning of five fishermen and the loss of six vessels off the west coast of Canada. The final Canadian report [16] stated that while satellite imagery showed the cloud pattern associated with the storm, it did not give a good indication of its strength or future development. The earliest indication of possible explosive development was from US buoys and two ships that were reporting rapidly falling pressures. Only several hours later did satellite imagery appear to indicate that the storm was changing character. The final report stated that ship reports, while useful, suffer from the fact that ships are moving, are often not positioned to best sample the weather, and provide little information at night. It noted further that "malfunctions and shifts in position of the Geostationary Operational Environmental Satellite (GOES) made it difficult to interpret the early images obtained from the storm". The technical summary of this storm stated that "*data from the stationary buoys ... were absolutely crucial in the determination of explosive deepening*", and the report's conclusion endorsed the value of moored data buoys. Canada now has its own moored buoy programme, with a number of buoys deployed in the Pacific and Atlantic Oceans and in the Great Lakes [2, 4f]. The poor observational coverage in the eastern Atlantic at a critical period of rapid development of the low that led to the *October '87* storm which devastated parts of southern Britain and northern Europe gave added impetus to the UK Meteorological Office (UKMO) proceeding with its proposals for developing a network of moored buoys in the north-east Atlantic and around its shores; this network was completed in 1995.

Buoys also provide ground truth for surface measurements from satellites. Space-based sensors are vulnerable to systematic biases that can only be compensated for by reference to such ground truth [25]. Buoys provide the most accurate data [40] and are being used to develop algorithms for satellite retrieval of winds and other surface parameters.

Buoy data are also an important source of observations for research studies, since they are usually the most accurate marine data available and normally one of the few long-time-series data sets from fixed locations. Research programmes on the marine boundary layer, wave generation and propagation, climate, pollution, etc., frequently use buoy data. Numerical model development for forecasting marine parameters uses buoy data

for verification purposes. In addition, buoy data are sometimes utilized as substantiating evidence in maritime law cases.

The need to analyse and predict internal *ocean weather* systems and other oceanic properties is growing in importance and the capability to do so is evolving. Measurement of the required subsurface data is a logical extension of an operational meteorological moored buoy network which reports environmental data in real time. A discussion of such measurement systems is included in the guide.

The initial costs to build, operate, and maintain moored buoys are rather high, as are the costs of deployment, mooring, servicing, and data management. However, when configured to report frequently (*e.g.* every hour), and considering that they operate a year or more without servicing and many of the components may be refurbished and reused, moored buoys are reasonably cost-effective over the long term. Furthermore, costs are being reduced by engineering advances, such as improved power systems, sensors, and more durable hull materials.

Buoys often have a limited suite of sensors, partly because of the unsuitability of some instruments in the marine environment. Performance limitations due to power supply are also important; however, the situation has improved dramatically with advances in microelectronics. Certain important measurements, such as subsurface data, are very difficult to achieve in an engineering sense. However, the case studies referred to in the previous paragraphs and numerous other descriptions of the importance of buoys can be clearly cited to make the case for the value of their environmental observations. Since the value of buoys and ODAS is apparent, the need exists to provide and share information about these programmes; this guide attempts to be that vehicle.

The definition of ODAS is as follows [32]: *ODAS means a structure, platform, installation, buoy, or other device, not being a ship, together with its appurtenant equipment, deployed at sea essentially for the purpose of collecting, storing or transmitting samples or data relating to the marine environment or the atmosphere or the uses thereof.* This is a strict definition that would rule out such platforms as instrumented oil rigs and other stations. For the purpose of this document, therefore, ODAS are interpreted to be stations which transmit real-time marine environmental data that can be used for forecasting purposes.

The coastal and offshore region represents a data-sparse area that is of vital importance to the fishing industry, recreational boating, and drilling activities. Although some national programs, such as the U.S.'s Marine Reporting (MAREP) program, encourage marine observations from smaller vessels, ships rarely send synoptic reports in coastal areas, and manual observations at Coast Guard navigational facilities such as lightships and lighthouses have been phased and replaced by automated equipment. ODAS in the coastal area have become increasingly important. To assist in the preparation of this Guide, WMO letter No. W/O/BY of 22 December 1995, was sent from the Secretariat to members of the WMO Commission for Marine Meteorology requesting that information be forwarded to the rapporteur for inclusion in the Guide. Countries responding to the survey are listed in Annex II, and information concerning their buoy and/or other ODAS programmes are contained therein. Material from the submissions is used in the text, but for complete information please refer to Annex II. Although dated, important material can also be found in reference [4], Proceedings of the **COST 43 Seminar on Operational Ocean Station Networks**, which is referred to in the guide.

2. MOORED BUOY HISTORICAL OVERVIEW

In the 1940s, the US Coast and Geodetic Survey instigated tests to determine the design of a buoy that would observe tidal currents and report by radio. The Navy continued the investigation and designed a boat-shaped, four-metre-long aluminium hull that would support meteorological equipment for transmitting observations automatically and unattended.

It was later determined that this hull did not have enough buoyancy to support the weight of an anchor line of sufficient length for mooring. It was then found that a similar buoy six metres long would be the minimum size capable of supporting the required weight. It was to be moored using a slack moor combining stainless steel wire rope, nylon line, polypropylene line, and railroad wheels for anchors. Clock-timed to operate every three hours, the buoy measured air and sea temperatures, atmospheric pressure, wind speed and direction, and integrated wind speed (the cumulated number of minutes the wind exceeded a preselected threshold during the previous hour). The information was automatically transmitted in Morse Code using High Frequency (HF) radio. Subsequently, about 20 of these buoys, called NOMAD for Navy Oceanographic Meteorological Automatic Device, were built in the 1950s.

In 1962, Hurricane Carla, one of the most severe storms on record in the Gulf of Mexico, passed close by a NOMAD. The wind speeds and pressures were beyond the calibration of the NOMAD's sensors, but the buoy survived the intense seas and winds. Maximum winds of 67 m s⁻¹ were estimated. Most of the Navy NOMADs are still in service with the US National Data Buoy Center (NDBC).

The early NOMADs were powered by storage batteries; however, in the mid-1960s a nuclear power plant generating system was installed and operated. A rocketsonde system was developed which probed the atmosphere, through the 500-hectopascal (hPa) level, for air temperature, pressure, and humidity. The data were copied by the NOMAD and retransmitted to shore stations. A NOMAD in the western tropical Atlantic was equipped with clamp-on subsurface transducers which included 14 temperature probes, one current speed probe, and one sound velocimeter. An interesting history of the NOMAD is found in [30].

The discus buoys used by the US evolved from a research programme conducted for the Office of Naval Research (ONR) during the early 1960s. Some 15 different shapes were studied, including boats, spars, and toroids. It was concluded that the 12-metre-diameter discus buoy was the most reliable solution for subsurface and meteorological measurements. The size was carefully considered and dictated by survivability. These buoys were successfully deployed by ONR in the Atlantic and Pacific Oceans, and in the Caribbean Sea. A severe hurricane was experienced by one.

The study considered aerodynamic overturning forces as well as hydrodynamic forces to be very important. A spoiler around the deck edge can be effective in minimizing wind forces. The angle at the wave crest and the height of the plunging water are important factors in capsizing. The natural periods of the buoy in roll, pitch, and heave are also important.

To obtain important environmental data during storms, the platform must be reliable as well as survivable. The costs of data acquisition and processing, system deployment, and maintenance were thought to be more significant than hull acquisition cost. This was the argument for using hulls large enough to provide the intended service reliably.

However, with the use of satellite communications and microprocessors, the escalating cost of the 12-metre hull became the major cost item, and the decision was made to build 10-metre discus buoys. The capsizing risk was assessed and believed to be acceptable. The 10-metre buoy was a compromise that was expected to have acceptable survivability and that would not introduce new problems in sensor performance through unknown responses of a different hull type.

Other developmental projects were initiated in the 1960s and early 1970s. A 2.4-metre-diameter discus buoy was developed which was designed for self-deployment and station-keeping by utilizing an aerodynamic sail. Twelve-meter-diameter *monster buoys* were built with both HF and Ultra High Frequency (UHF) antennas so as to be able to transmit via geostationary satellites. Electrical power for the "monster buoys" was supplied by two four-cycle engine/generators, utilized alternately for charging a nickel-cadmium battery bank. Toroid buoys were constructed that were doughnut shaped with a protective superstructure. They were found to be difficult to launch from shipboard because of the unhandy length of the counterweight necessary for in-water stability. They could not be boarded for repair and had limited reserve buoyancy. Experiments were conducted with catamaran-shaped *Bumblebee* buoys. Five-metre-diameter discus buoys were built and deployed in the North Pacific, but in extreme wind and wave conditions they were found to capsize. Both accelerometer and pressure variation instruments were tested at sea for measurement of sea state. Other developmental projects included titanium moorings, precipitation detectors, and both strain gauge and hot cylinder anemometers.

Early buoy deployments were fraught with troubles. Buoys were damaged by deploying vessels, sank mysteriously, sustained many mooring failures and went adrift, and experienced many early sensor and electronics problems. These reliability problems were gradually isolated and solved. Electronics and sensor improvements were subsequently defined and demonstrated. System performance improved.

The first US buoy system specifically designed for operational application was NDBC's 10-metre-diameter discus buoy, which was built in 1974. It was designed to obtain environmental observations at lower cost than the 12-metre buoys, which were very costly to build, operate, and maintain. To further reduce the cost of deployed buoys, NDBC developed a small three-metre discus buoy that was initially designed by the Woods Hole Oceanographic Institute (WHOI) [38].

The Japan Meteorological Agency (JMA) has conducted an Ocean Data Buoy Programme since 1968 (Annex II). The first of two pilot buoys was fabricated in 1968 and the second in 1969. They were three-ton, 3.5-metre-diameter discus buoys. Test deployment and operation of the buoys were carried out in the Sea of Japan from 1969 through 1972. The first of this series of operational buoys was fabricated in 1972 and deployed at a site about 770 kilometers south-west of Tokyo in 4 160 metres of water from August 1973 to May 1974. The JMA then started deploying buoys in the seas adjacent to Japan.

Over the years, the UKMO has experimented with a number of moored buoy systems from small (2.5-metre) inshore types to large open-ocean buoys with diameters greater than eight metres. Much experience was gained through co-operative programmes (some international) and an operational network of 29 moored buoys and platforms is established. A description of the programme is given in [24] which also describes the BOSCO and ODAS-20 buoys. France and the UK collaborated in an experiment to moor a data buoy in a deep-ocean area. The BOSCO buoy is described in [3a], and operational experience with the ODAS-20 buoy is given in [3g].

The first Norwegian experiments with moored meteorological buoys were carried out in 1964 and 1965 in the Norwegian Sea. Extensive experiments followed with drifting buoys in the period 1965 to 1968 and from 1968 with moored buoys [28]. From 1976 to 1980 the Norwegian Meteorological Institute and the Icelandic Meteorological Office cooperated in the operation of a moored spar buoy, ODAS MET 20, approximately 350 km south-west of Iceland. From 1981 to 1983 this buoy was operated in a new position approximately 350 km south-east of Iceland, between Iceland and the Faeroes, as a cooperative project between Norway, Iceland and the United Kingdom. Two buoys, now called ODAS 451 and ODAS 452 were used alternatively [5].

Norway is operating a moored buoy network in the Norwegian Sea and in ice free areas in the Barents Sea. This programme is to support marine weather services for oil exploration and production in the area. Guddal and BJORHEIM [12] describe the system.

From 1988, Denmark, Germany, Iceland, Ireland, the Netherlands, Norway, Sweden and the United Kingdom have cooperated within the European Group on Ocean Stations (EGOS), the first Action Group of the DBCP. The main purpose of EGOS is the operation of a joint network of drifting and moored buoys for the real-time acquisition of meteorological and oceanographic data in the North Atlantic Ocean. From 1993 to 1996, six moored buoys along with several drifting buoys, have usually been in operation at any one time creating a very useful network of observing stations on the high seas in the North Atlantic.

The Canadian moored buoy programme operates 33 stations in the Atlantic and Pacific Oceans and the Great Lakes [2]. In deep water, NOMAD hulls are usually used and three-metre discus buoys are deployed in coastal, inlet, and Great Lakes regions. There are also two 12-m discus buoys in Lake Ontario and a Hexoid and TOGA buoy in Lake Winnipeg.

Finland has deployed buoys in the Gulf of Bothnia ([4j], [4k]). The buoy selected, the WEBOS, has the wind sensors at about 4.5 metres above the surface, with the maximum width of the buoy being 3.5 metres. The buoy measures wind speed and direction, air and water temperatures, pressure, humidity, incident radiation, temperature profile with depth, conductivity, and directional wave spectra.

The Australian Bureau of Meteorology has experimented with mooring drifting buoy hulls similar to those used in the TOGA programme. The experiments were generally successful; the buoys operated up to 15 months and provided useful data. They are experimenting with a Wind Speed and Direction (WSD) drifting buoy hull, except moored with a swivel in the mooring line.

Two moored 3-m discus buoys were deployed by NDBC in support of TOGA. One station, off the coast of Chile, operated for 10 years, with Chile assuming responsibility for the servicing, maintenance, and repair of the buoy for most of that time.

3. MOORED BUOYS

3.1 Hulls

Moored buoy hulls must withstand severe sea conditions and not capsize, and must be stable enough to provide a good platform for measurement systems. In some cases, the hull/mooring system design must minimize the inherent conflict between the need for a stable platform to measure winds, but have adequate water surface-following characteristics to determine sea state. The analysis and testing required to identify the appropriate ocean buoy design is discussed in [29]. The hull configuration must be easily deployable by the

deploying vessel and it must be serviceable at sea either by small boat or by hoisting aboard ship. The buoy should be easily transportable both at sea and on land. Finally, the initial procurement and on-going maintenance costs of a particular hull are always elements which have to be considered. Choice of hull type depends on many factors. The following paragraphs discuss various hull types.

3.1.1 Boat shaped

The development of the boat-shaped NOMAD hull was reviewed in section 2. A picture of an original NOMAD is given in Figure 1. The buoy is six metres long and displaces about 10 000 kilograms, about half being ballast. In operation, NOMADs tend to follow the sea. They are highly directional and have a quick rotational response. They will frequently roll well over, but have good stability due to a low centre of gravity and also due to the mooring attachment at the end of a bridle that is rigid in the roll plane.

There are no known cases of NOMAD capsizings. However, sensor damage has occurred in heavy weather and sensors have received damage due to icing conditions on northern deployments. This damage is due largely to the fact that the sensors are at the five-metre level above the water.

The size of the NOMAD is a great advantage in transportation. It can be transported by truck or rail, or carried on deck of the deploying ship if desired. The size also proved to be an advantage when one went aground after a mooring failure, and it was possible to use a helicopter to refloat the buoy when conventional salvage procedures would have been very difficult.

The serviceability of the NOMAD is good. It is not difficult to board from rigid-hull inflatable boats and the onboard motions are not overly objectionable while working. Spray can be a problem, and obstructions on deck are hazardous. Below-deck access through hatch covers can be difficult in rough seas.

The accuracy of measurements (particularly wind) has been questioned because of the NOMAD's severe roll response. However, when a NOMAD was moored alongside a 12-metre discus buoy, the measurements were found to agree satisfactorily [10]. Directional wave measurements are considered difficult or impossible to obtain from a NOMAD because of its boat shape and wave-following characteristics.

3.1.2 Toroid

The toroid buoy was developed at WHOI in the late 1950s. The toroid was symmetrical, inexpensive, and had ample buoyancy. A tower was added at the top and a polypropylene mooring was used. Many of the early buoys capsized; the mooring did not remain taut due to creep of the polypropylene, and the restoring moment it provided was small because the mooring was connected directly to the buoy. Several mooring variations were tried, including wire rope, nylon, and a chain sling. Foam installed at the mast top helped to right overturned buoys, but the solution to survival was a stiff bridle added below the buoy. Its length was about the same as the tower height, *i.e.* slightly greater than the buoy diameter. WHOI has deployed many buoys of this type and has experienced no capsizings since adding the bridle. WHOI uses 2.4- and 3.7-metre-diameter toroids, having 2 700 and 3 400 kilograms buoyancy, respectively. The Pacific Marine Environmental Laboratory (PMEL) of the U.S. has deployed a network of 69 2.3 metre-diameter toroids in the Tropical Atmosphere Ocean (TAO) array across the equatorial Pacific [18]. They are normally stored on deck on their sides and lifted into the water by crane. The UKMO uses a 2.5 metre toroid buoy with all chain moorings in water depths to approximately 70 m. No problems of capsizing have been experienced.

3.1.3 *Bumblebee*

The Bumblebee buoy evolved over a period of time from the requirement to make surface measurements during the Bikini Island atom bomb tests. Initially, off-the-shelf fiberglass skiffs were moored to take the measurements, but they overturned. Small styrofoam floats were then used fairly successfully, but these buoys capsized in subsequent higher sea states. For a later North Pacific application, ability to survive severe seas was required. Ballast, which increased buoy weight, was undesirable. Experimentation eventually led to the final concept in which an upper structure was added. Ultimately, a platform was added to the stern to facilitate boarding at sea. Length was increased to allow successively larger payloads and larger mooring lines. Several of the buoys were as long as six metres.

Bumblebees are quick to respond to sea-surface forces. They dart around, changing direction quickly, usually staying in the wave troughs. Their survivability may be due to their avoiding the crests more than to any inherent stability.

3.1.4 *Discus*

The most dramatic change in buoy hulls from the perspective of size has occurred on discus shaped buoys. The 12-metre buoys were survivable even in extreme conditions. Efforts to reduce costs led to the 10-metre hulls (Figure 2).

Operational experience with 10-metre buoys has been generally good when deployed in less severe environments. However, there were several capsizings in high sea states by NDBC hulls in the Gulf of Alaska, and Japan had a 10-metre buoy capsize in a typhoon in 1986 (Annex II). Ten-metre hull motions are more lively than those of 12-metre hulls, so boarding and working are somewhat more difficult.

Engineering advances in electronics and power systems made much smaller hulls feasible. The three-metre discus buoy, like the NOMAD, is constructed of aluminium, which reduces corrosion and magnetic effects on the compass, and can be transported on the deck of a ship or on a flatbed truck. The buoy can survive in high seas and provides excellent measurements, but must be retrieved and serviced on the support vessel unless the sea state is fairly benign. The mast folds to permit crane access to the central hull compartment. A three-legged steel mooring bridle beneath the buoy provides additional stability. Anemometer heights are approximately five metres above the sea surface as opposed to ten metres on the larger discus buoys.

In 1982 and 1983, NDBC instituted significant modifications to the WHOI-designed, three-metre buoy. To investigate the quality of the three-metre buoy measurements, extensive data evaluations were conducted at four locations for a period of many months [13]. The three-metre buoy was judged and declared to be operationally qualified to meet NDBC quality standards for measurements. Because of the difficulty of servicing the buoy at sea, it is used primarily in coastal areas. WHOI uses their three-metre buoy extensively for research purposes with both surface and subsurface sensors ([38],[39]).

In the early 1990s, NDBC began testing 3-metre discus buoys made of closed-cell ionomer foam that encircled a standard aluminum payload well. Ionomer foam provides greater buoyancy, less susceptibility to damage, and reduced maintenance costs. Even smaller discus hulls (*e.g.* 2.4-metre diameter) are used in near-shore, relatively protected locations.

3.1.5 Semisubmersible

A design study of a semisubmersible buoy and tests of a scale model in a wave basin demonstrated that this concept had excellent survivability in large breaking waves. It is similar in concept to semisubmersibles used as drilling platforms, and the construction resembles four spar buoys with an interconnecting structure. It had a design displacement of 75 000 kilograms, but could be deballasted to a significantly reduced draft for movement. Model tests showed that the buoy would incline less than six degrees 95 per cent of the time in seas with four-metre significant wave heights and would survive 18-metre breaking waves.

3.1.6 Other hulls

A three-metre-long, horizontal cylinder-type buoy was found to have lively pitch and roll responses that limited its usefulness in all but the calmest seas. An expanded version was later considered, and scale-model tests of both frequency response and survivability were made. Results indicated good hull survivability but probable superstructure and sensor damage in large breaking waves since the hull either broaches or submerges in breaking wave crests.

Large spar buoys have operated successfully. Long spars normally provide a very stable platform; however, handling such a large buoy and boarding for servicing pose many operational problems. Spar buoys tend to incline or even submerge in currents or winds, and if wave periods approach the buoy's natural period, extreme heave motions and heave-to-pitch coupling may be experienced. Damage in large breaking waves is possible. Procurement and operating costs are high. However, the large spar is suitable for some specialized applications, such as the FLIP vehicle operated by the Scripps Institution of Oceanography.

In the late 1980s, the UKMO developed a cylindrical semi-spar style buoy 2.8 metre in diameter. A closed cell foam buoyancy collar protected by a highly abrasion resistant self-coloured elastomer coating surrounds a cylindrical steel equipment well. A marine grade stainless steel superstructure incorporates a *crow's nest* sensor mounting structure to simplify sensor exchange at sea. These have been deployed very successfully off the Continental Shelf in the eastern Atlantic, and in shallow waters where the sea conditions demand a good reserve of buoyancy.

3.2 Moorings

The early years of mooring activities were devoted to research, model testing, and actual field measurements. The goal was to provide a long-term, deep-water mooring that would be simple in design, fabrication and deployment, and relatively low in cost. Since data buoys would not be used for navigational purposes, tight mooring watch circles (radius of movement of buoys due to wind and current) were not a requirement. This allowed for the choice of a single-point mooring with liberal scope. Several of the first mooring systems were required to accommodate underwater sensors that complicated the mooring system and needed a taut or semi-taut mooring. These early designs were difficult to deploy, were costly, and required acoustic releases for recovery. Moorings without subsurface oceanographic sensors allow for simpler, cheaper, and easier deployments.

During the middle 1970s, NDBC used moorings that were either all chain or a combination of chain and long lengths of nylon line. With the advent of new technology and suggestions from outside agencies, several changes were incorporated. Three standard designs are used today. While the lengths of the various components may vary from site

to site, the overall basic design remains the same. A description of NDBC mooring systems is given in [37].

The three basic designs, shown in Figure 3, are an all-chain mooring, a semi-taut mooring, and an inverse-catenary mooring, of which two variations are used. Additionally, each mooring that is used with a particular hull is divided into three distinct sections: an upper mooring, a middle mooring, and a lower mooring. The upper mooring for all buoy hulls consists of the short length of chain used directly beneath the hull, whereas the lower mooring is composed of the chain (suspended off the bottom to prevent chafing of the middle mooring) and anchor used on the bottom end of the mooring. The middle mooring configurations contain the various sizes and types of line (nylon and polypropylene) and flotation that are used between the upper and lower mooring. The lengths of the middle mooring components are not shown on the drawing since the lengths will be dependent on the specific site. Buoys are routinely moored in water deeper than 5,000 metres.

The mooring type and specific design to be used for a particular mooring will be determined by the system considerations and the site location. Several of these considerations are discussed below in relation to how each affects the mooring design choice:

- (a) **Buoy hull:** The designation of a particular hull for a selected mooring site will aid in determining which mooring system should be used. Smaller hulls have limited buoyancy that may limit the size or amount of line and/or chain being used in the mooring in deep water. The type of buoy hull will also determine the mooring component sizes through strength requirements; larger hulls exert a greater load on the mooring and thus require greater mooring strength, which is essentially accomplished through component size increases;
- (b) **Water depth:** This is the main criterion that will determine which particular mooring system can be used for a given site. This information is usually obtained from a nautical chart for design purposes and then verified on scene during buoy deployment. NDBC uses all-chain moorings in depths less than 70 metres because of probable damage to synthetic lines;
- (c) **Bottom conditions:** The deployment site should be relatively flat with no steep slopes, drop-offs, or seamounts. The type of bottom may also be of concern to the mooring system, primarily in shallow water. A coral or rocky bottom, where an anchor cannot dig in, may require additional bottom chain or a dead-weight-type anchor;
- (d) **Environmental conditions:** All NDBC moorings are designed for survival in 50 m s⁻¹ winds, 1.5 m s⁻¹ current, and 10-second waves, unless a particular site warrants a reduction or increase for expected weather conditions. The possibility of the buoy being subject to ice loading will greatly affect the performance of a mooring. Studies have shown that moving ice can produce loads as much as 20 to 30 times the normal load;
- (e) **Design life:** All NDBC moorings, except all-chain moorings (two-year design life), are designed for a minimum six-year life expectancy. Safety margins and strength requirements are established to achieve this goal. Some moorings have lasted in excess of ten years; at the time of this writing, one mooring is still operating after 15 years! The upper mooring is normally replaced every two or three years when a buoy hull is exchanged on the existing mooring. Periodically, a situation may require a short-term mooring. In this case, it

may be possible to reduce the component sizes, thereby reducing the cost of the mooring;

- (f) **Special considerations:** Special considerations would include proximity to shipping, sea lanes, or fishing areas. If close to shipping lanes or navigational channels, the watch circle may have to be reduced in order to keep the buoy clear from possible collisions. In areas where heavy fishing occurs, there is a possibility the mooring may become snagged or entangled by this type of gear, especially longline or trawl fishing, causing failure of the mooring. As added protection in such situations, additional chain is added to the upper mooring down to a depth of 120 metres or the maximum depth allowed by the buoy at that station;
- (g) **Fishbite:** Fishbite is damage that is sporadically inflicted on mooring lines by marine animals, particularly sharks. Most fishbite failures experienced have been partial bites through 60 to 80 per cent of the mooring line, with the remaining strands failing under subsequent tension. One approach to protect against this is to extend the upper mooring chain length down to a maximum depth allowed by the buoy hull. Some buoy operators use wire cable but this is more difficult to deploy and retrieve. WHOI has used jacketed steel wire rope in the upper 2,000 metres of moorings in order to prevent fishbite [38]. Another approach is to use oversize mooring line throughout the fishbite zone (thought to be the upper 2 000 metres). The theory is that this will allow the line to suffer a partial fishbite and still keep enough mooring line intact to successfully hold the buoy on station.

3.2.1 *Mooring line*

Discussed briefly below are the synthetic fibres most commonly used in the manufacture of mooring lines today:

- (a) **Nylon (Polyamide):** Nylon has high strength and high elasticity coupled with good abrasion resistance and cyclic loading performance;
- (b) **Polyester (Dacron):** Polyester is very similar to nylon in performance and appearance. Polyester offers low elongation, similar strength, heavier weight, and higher costs compared with nylon;
- (c) **Polypropylene (Olefin):** Polypropylene is the most popular material for buoyant ropes due to its overall strength, elongation, and seawater performance. The one drawback is its relatively rapid deterioration in sunlight. Dark-coloured ropes are not as susceptible to ultra-violet light damage and are therefore recommended over lighter-coloured ropes;
- (d) **Polyethylene (Olefin):** Polyethylene is very similar to polypropylene; however, it is not as strong nor as buoyant. It is often used in noncritical applications where some buoyancy is required or as a component in blended ropes.

Elongation or stretch of a mooring line is an important factor for consideration in mooring design. How much or how little and under what loading a line stretches will impact the performance and the longevity of the mooring. In the design of shallow-water and depth-dependent mooring systems, accurate allowances for the stretch of the mooring line must be made.

3.2.2 Chain

Corrosion, which is the degradation of a material through reaction with its environment, is by far the most important concern regarding materials in the marine environment. Degradation of mooring components can lead to reduced strength and, ultimately, failure of the mooring component.

Chain used in moorings should be manufactured from a uniform carbon steel in accordance with industry standards. Chain manufactured from scrap metal or several types of steel should not be used since their performance in seawater cannot be adequately predicted. The same is true for high chromium and nickel alloy chain. Although high in strength, their performance in seawater has not been proven. The weld areas of these types of chain link are susceptible to stress corrosion cracking and fatigue failures. Mooring chain for buoys is typically referred to as *open-link* or buoy chain. The construction allows for easy assembly of long lengths required in preparing a buoy mooring. *Stud-link* chain, which has a stud welded or forged in the opening within the link, is typically of higher strength than open-link chain.

3.2.3 Mooring assembly components

Just as important as mooring line and chain are the components used to assemble lengths of these materials. Shackles with safety keeps are the recommended method of connecting mooring hardware components, due to their simplicity and security. Proper metal-to-metal combinations are needed to avoid electrolytic reactions and rapid corrosion by seawater. Thimbles are used to terminate synthetic rope ends for connection to the remaining sections of the mooring. Many types and shapes of thimble are available.

PMEL deployed buoys that measure subsurface temperatures and currents along the Equator in the Pacific Ocean in support of TOGA [21]. Since the conclusion of TOGA, the network continues to operate as the TAO array [18]. Non-rotating wire rope is used to a depth of 700 metres to guard against fishbite damage. Plaited eight-strand nylon line is used for the remainder of the mooring. The system is taut-moored. The BOSCO buoy had mooring components (from upper to lower moorings) of chain, multiplait polyester, subsurface float superline polyester, deep float acoustic release chain, and a clump anchor [4a].

3.2.4 Anchors

Many types of anchor are currently available for use in a mooring system, offering a wide range of choice. Many of the more commonly used anchors with suggested holding power ratios are shown in Figure 4. The Stato and Danforth anchors are the most effective designs for applications from lightweight moorings to heavy, deep-water moorings. Where rocky or coral bottoms are found, fluke-type anchors are unable to dig in, therefore concrete or steel clumps (dead-weight anchors) with oversized lower mooring chain provide the most effective anchor system.

When selecting an anchor it is essential to know what loads will be placed on the anchor. The anchor system should be designed such that under maximum load conditions the force at the anchor remains horizontal, even in extreme environmental conditions, in order to provide the maximum holding capacity of the anchor. In some applications, such as deployment where an ice pack may form, it may be prudent to size a clump anchor to allow movement from the deployed location rather than having it hold firmly and risk parting of the mooring.

3.3 Electronic payloads

The electronic payload controls and performs many functions required to collect information from the sensors, processes the data, and prepares data for transmission. They are often referred to as Data Collection Platforms (DCP). An electronic payload used by NDBC is described herein for illustration, since it is state-of-the-art and probably representative of payloads used around the world. Descriptions of DCPs from other countries can be found in Annex II (*e.g.* Japan DCPs reporting via GMS; France, Germany and the Netherlands via METEOSAT).

One payload system used by NDBC to collect and report environmental data is called the Multifunction Acquisition and Reporting System (MARS). The MARS has been designed to operate unattended for up to three years. Data may be collected from an array of sensors providing analog, pulse-based, or serial data strings. The data are processed and reported via GOES or any communications system capable of transmitting ASCII characters. MARS also includes the capability to use modems and cellular telephones. The system may be configured for operation on a buoy or on land.

The MARS electronics unit contains the following three major components:

- (a) Power and signal conditioning;
- (b) Data processing;
- (c) Transmission section.

Sensor and processor power are switched on and off to conserve power. Each sensor is powered by a module with a specific system address, and several power modules are designed to provide a variety of voltages to match the needs of the sensors and MARS. The power modules plug into a custom motherboard; each motherboard socket is addressed and supplies 12 VDC battery power. Sensor signal conditioning uses the same motherboard - daughterboard strategy. The conditioning provides signals to the data processing section that are within the capabilities of the analog-to-digital converter system. Once conditioned, the signals are routed to the appropriate STD bus in the data processing section. The basic brain and heartbeat of MARS, as well as interface capabilities, reside in the data processing section. The transmission section is usually a *smart* GOES transmitter, but may be any other communications capable of transmitting in ASCII.

When placed on a buoy, an omnidirectional antenna is used and dual compasses are employed to determine buoy heading. On fixed stations, a directional antenna is used. The MARS 40-watt GOES transmitter is standard on buoys and a 10-watt transmitter is at fixed sites. A test set is used to calibrate, test, and deploy MARS systems. The system can process data from many sensors, including the following:

- (a) Barometric pressure;
- (b) Wind;
- (c) Air temperature;
- (d) Water temperature;
- (e) Sea state measurement;
- (f) Position fixing;
- (g) Tide;
- (h) Solar radiation;

- (i) Humidity;
- (j) Precipitation;
- (k) Visibility;
- (l) Additional sensors that provide serial RS-232, digital state outputs.

For engineering and system monitoring purposes, the MARS also measures and reports battery voltage, battery charge current, dead-man timer reset occurrence, LORAN sensor failure, and serial port failure.

The MARS electronics are packaged in a sealed pressurized container. Humidity within the enclosure is controlled by a desiccant. The system has been tested over the range of -40°C to $+50^{\circ}\text{C}$. The MARS is powered by 12 volts Direct Current (DC) and requires a maximum current of 10 amperes (buoy configuration) during satellite transmission.

In normal operation the system will stay in a sleep mode, monitoring the internal clock until the specified data acquisition time. Sensor data are then acquired for the specified interval, and then transmitted to the satellite at the allocated minute of the hour. Timing is based on an hourly cycle such that the sleep, acquisition, and transmit modes occur every hour, or multiple of one hour. More frequent, regular data acquisition and transmission (e.g., every 15 minutes), is programmable for special observation needs.

All specified times are stored in nonvolatile memory by the operator or service technician, using a test set, telephone modem (for some fixed platforms), or terminal. In addition, many system set-up parameters and constants are also stored, such as enable/disable individual sensors, and second-order equation coefficient entry for nonlinear sensor correction.

Canada's procurement of deep-sea buoys (NOMADs) resulted in the acquisition of the ZENO electronic payload. The ZENO was designed by Coastal Climate Company of Seattle, Washington, and the units were built in Sidney, British Columbia, Canada under license by Seastar Instruments [4f]. Some operating characteristics of the ZENO are discussed in [2]. Canada is planning to replace the ZENO with the new Watchman 100 payload.

The UKMO developed a dual sensor and electronics payload based on the Cambell Scientific CR10 data logger and METEOSAT DCPs. Full crossovers between each data collection and transmission system ensure redundancy and maximum data returns.

3.4 Sensors

Because of possible damage to the sensors by waves and to conform with standards for location of sensors above the water surface, a mast or tower is usually installed above the deck of the buoy to support the meteorological instruments. The best arrangement is to keep as many of the instruments and as much of the electronics as possible within the buoy's hull. This means that the barometers, water temperature sensor, magnetic compass, and wave accelerometer, in addition to the data acquisition/telemetry package and battery power source, can be installed below the deck of the buoy. In order to simplify service at sea, the UKMO deploys barometers outside the hull. A very important activity, necessary to ensure the quality of the meteorological data obtained from the field, is the pre- and post-deployment laboratory calibration of all sensors. The procedure used in the TAO array by PMEL is discussed in [17]. Also, magnetic compasses need to be checked for accuracy.

Total system accuracy can be defined as the accuracy to which a measurement, when available to the user, can be quality controlled. For example, a barometer can be

calibrated and accurate to 0.1 hPa when deployed; however, over time the sensor may drift and 1 hPa is about the extent to which analysts can determine its validity. WHOI reported on sensor drift with time [39]. The values in Table 1 may vary in different locations (*e.g.* the barometric pressure lower limit of 900 hPa may be adequate in most regions, but in tropical cyclone areas instances of values less than 900 hPa may occur). Also, many of the values differ among programs and agencies because requirements often vary significantly according to users' applications. The basic standards of instrument and observing practices that are required by present-day international standards can be found in [43].

3.4.1 Anemometers

Anemometers used in operational buoy programmes include the propeller-vane type, and the cup anemometer and wind vane. WHOI has deployed a Wind Observation through Ambient Noise (WOTAN) instrument [39].

The propeller-vane type uses the vane to orient the wind speed transducer into the wind and measures both wind speed and direction. A commonly used anemometer of this type was the highly reliable Bendix Aerovane, which weighs 6.5 kilograms. In an attempt to make anemometer replacement easier on buoys at sea, NDBC initiated the development of a smaller, lighter weight propeller-vane anemometer in 1981. The R.M. Young Company now produces this wind sensor, which is called the Wind Monitor, in both analogue and pulse-forming systems. The pulse-forming system senses the rotation rate of the four-bladed propeller and wind direction is sensed by a resistive plastic potentiometer. Total weight of the R.M. Young anemometer is 1.5 kilograms. The performance of the Wind Monitor has been found to be satisfactory, and, with its relatively low cost and weight, has become the standard anemometer on NDBC buoys as well as other programs (Annex II).

The cup-type anemometer is widely used because of its simplicity and sensitivity. The speed of rotation of the cups (usually three) is a function of the wind speed. Small generators, mechanical or magnetic switches, and photoelectric and capacitance choppers are used to determine the speed of rotation of the cup assembly. Wind direction from the vane can be determined by potentiometers or shaft encoders; on the BOSCO buoy, the wind direction was measured by combining the outputs of a fluxgate compass, giving the orientation of the buoy with regard to magnetic north, and a wind vane giving position with regard to the wind direction [4a]. The two anemometers on the UK moored buoys have self-referencing wind vanes and cup anemometers specially modified for use in the marine environment, and some results of comparisons, both inter-sensor and against background fields are discussed in [15].

The ODAS-451/452 buoy wind speed was monitored by a three-cup anemometer which was mounted on the top plate of the buoy about two metres above sea level [4i]. The wind direction was monitored by a wind vane installed on the top of the buoy at the same level as the wind speed sensor. The azimuth angle of the wind vane relative to the buoy was monitored by a vane-following potentiometer, and the orientation of the buoy relative to magnetic north was determined by a standard analogue compass. The wind direction relative to magnetic north was then determined by combining these two directions.

Cup and vane anemometers have been found to overspeed in gusty winds and have errors introduced by vertical components of the wind resulting from buoy motion. WHOI found that cup speeds averaged 5 per cent higher than propeller speeds [39]. However, one study has shown that the cup and vane and propeller-vane anemometers give similar results.

Winds on buoys are one of the most important parameters measured, but they are subject to some misunderstandings. Experienced marine forecasters have, at times, felt that buoy winds are too light in comparison with ship winds. However, most of the disparity can

be attributed to differences in anemometer heights and averaging times. The problem is dealt with in detail in [40]. The averaging time for determination of marine winds is recommended to be 10 minutes in [42] and other WMO publications. For buoys, this length of time tends to filter out the effects of buoy motion. Algorithms can be applied to extrapolate winds to common heights. For a discussion of moored buoy winds see [9].

Anemometer failures at sea are a common cause for service visits. Installing dual anemometers on buoys has been found to be a cost-effective method to alleviate the immediate urgency for an expensive service visit involving costly ship and personnel resources. Additionally, dual anemometers represent the best data quality-control tool, since the measurements can be compared with each other. The use of redundant sensors for data quality control is advocated in [44]. WHOI has used redundant meteorological instruments, each with a complete set of sensors, to maximize the likelihood of collecting a complete dataset [39]. The UK also uses two identical anemometer systems.

Since a major cause of anemometer failure is mechanical wear, alternative technologies are being investigated to increase reliability. One possibility is anemometers with no moving parts. While there are several categories [6], two general kinds of anemometers show the most promise: sonic and dynamic. The sonic variety measures wind velocity from the arrival times (or phase) of acoustic signals transmitted across a fixed path. The dynamic type is designed to sense pressure or drag force on an object placed in the wind flow.

NDBC uses a large wind vane mounted on its three-metre buoy masts to align the hull with the wind (Figure 5). This was begun for a research project involving the study of waves. However, a side benefit is that the azimuth of the hull orientation can be used to closely estimate the wind direction. Also, on buoys with a heave-pitch-roll sensor for directional wave measurements (section 3.4.5), the pitch angle of the buoy has been found to be proportional to, and therefore an estimate of, the wind speed.

3.4.2 Barometers

A number of countries use Rosemont barometers. These sensors have a variable capacitance pressure transducer as the sensing element, which converts the applied atmospheric pressure to an electrical variable that, in turn, can be electronically conditioned to produce a usable output signal.

Japan uses a variable capacitance ceramic sensor (Annex II). The French/UK BOSCO buoy [3a] barometer used an aneroid capsule associated with a capacitor. The resulting change in capacitance is converted into a frequency. A correction is made for changes in temperature. The accuracy of the measurement over one minute is better than 0.5 hPa. The UK pressure sensors are aneroid or vibrating cylinder barometers, or a non-rotating static pressure head which was designed by the UKMO. Canada uses a combination of AIR and ParoScientific barometers [2, 4f] as WHOI has done [39].

A basic problem with atmospheric pressure measurements is the dynamic effect of wind on the pressure of the air at the entrance port of the transducer. An increase or decrease in pressure relative to the static value is possible, depending on the relative orientation of the surfaces that modify the airflow in the vicinity of the pressure port. Another problem that can be experienced is a sensitivity of the transducer both to the force of gravity and to accelerations due to buoy motion. In this case, these sensors must generally be installed with their most sensitive acceleration axis orthogonal to the direction of greatest acceleration. Protection to prevent the intrusion of water and spray into the pressure port must also be provided. Attempts to shorten the power cycle of barometers

to reduce overall power consumption can produce large measurement errors; longer settling times before data acquisition can usually solve this problem.

3.4.3 *Air temperature sensors*

Temperature transducers installed in air temperature sensors are frequently either platinum resistance-wire type or the thermistor type. For air temperature and wet-bulb temperature measurements, Japan uses a ventilated psychrometer with platinum thermometer probes. Water drops are fed to the wet bulb at the beginning of each measurement (Annex II). Canada uses Yellow Springs Instruments temperature thermistors [2] as does WHOI [39].

Exposure of the air temperature sensor to the free airflow must be considered when the buoy masts are designed. Wind passing around a nearby surface that is not in thermal equilibrium with the air before reaching the temperature sensor can produce measurement errors. A major source of error in the measurement of air temperature is localized heating due to solar radiation. Radiation shields can be vaned or stationary and are wind aspirated to remove the heat. The effectiveness of these shields is reduced at very low wind speeds but they provide adequate performance when the wind is greater than 2 m s⁻¹.

3.4.4 *Sea-surface temperature sensors*

The same transducers used for measuring air temperature are often used for measuring the temperature of the water adjacent to the buoy. The transducers can be installed in an exterior hull-mounted arrangement, wherein penetration of the hull is achieved using a well pipe in order to contact the water directly. Another method is to sense the water temperature by attaching a thermistor transducer to the inside of the hull's bottom plate, and in direct contact with it. A thermal insulating cover prevents excessive heat transfer from the surrounding air in the buoy's hull and reduces measurement errors to an acceptable value. The measurement is usually taken at a nominal depth of one metre.

3.4.5 *Wave sensors*

Measurement of surface gravity waves is accomplished by sensing the vertical acceleration caused by passing waves. The output of an accelerometer is an electrical signal that is an analogue of the acceleration. Further processing of the signal, using both analogue and digital methods, yields statistical parameters that characterize the wave conditions. Significant wave height, wave period, and wave spectra over the frequency range from 0.01 to 0.40 Hz are obtained.

A vertically stabilized (gimballed) accelerometer may be used so that the true vertical acceleration can be obtained. However, for one-dimensional spectra it has been found that a fixed accelerometer strapped to the buoy can give acceptable results at a lower cost, if appropriate corrections are made. For directional wave measurements, a gimballed accelerometer is required as part of a heave-pitch-roll sensor used in conjunction with a magnetometer for determining direction. Estimates of directional wave spectra can be constructed from the time-series records of the water surface displacement, east-west slope, and north-south slope. Discussion of directional wave measurement techniques can be found in [27]. An evaluation of NDBC directional wave measurements is given in [11]. The results of a comprehensive field trial of nearly all commercially available directional wave systems at a site in the North Sea during winter 1985/86 are presented in [1].

French capabilities in providing both directional and omnidirectional (one-dimensional) data are given in [7]. They have developed an electronic module, compatible with existing Waveriders, which computes the omnidirectional spectrum of sea

state onboard and transmits the results using the Argos system. They also have instrumented buoys with DATAWELL HIPPY sensors to obtain directional spectra.

Output voltage of the JMA accelerometer is integrated by a double integrator, and acceleration is transformed into relative displacement of the buoy hull. An average of displacement in 400 seconds is taken as wave height, and 20 successive waves are counted to determine wave period (Annex II).

Wave measurements, including estimates of the energy spectra, are now accepted and considered to be critically important by operational marine forecasters in the USA. for both marine and surf forecasting. This is particularly true when wave information is co-located with wind measurements. As a result, NDBC (US) has worked toward developing a lower cost wave system that is accurate enough for operational purposes. The NDBC magnetometer only (MO) system uses output from a two-axis magnetometer and an inclinometer, without a standard heave-pitch-roll system [26]. The conclusion from a field evaluation was that data quality were usually comparable to the standard for operational use.

3.4.6 Subsurface sensors

Subsurface measurements discussed here are considered to be those taken and transmitted in real time as part of an operational moored buoy network for distribution over the Global Telecommunication System (GTS) and other communication circuits.

Subsurface measurements are vital to a number of programmes including fisheries, numerical modelling, pollution control, naval applications, and climate monitoring. Recognizing these needs, NDBC held an Ocean Profiling Workshop in June 1976 to identify the various uses and applications for subsurface temperature data and to define the data measurement requirements for these applications. Table 2, reproduced from [23], summarizes these data needs and measurement characteristics.

Currents are needed to study ocean circulation and are used to design and improve ocean circulation models that ultimately will be used in efforts to predict climate change.

Chemical, biological, and water quality properties of the water column are of great interest in many disciplines, including pollution control and fisheries. Due to fouling and other factors such as calibration problems, these measurements are very difficult to maintain over a long period. However, the needs for these buoy measurements are expected to grow, and development and testing of sensors will therefore produce better quality instruments. In 1993, NDBC conducted another buoy workshop to determine both data requirements and their technical achievability [34]. Table 3 summarizes the consensus of the workshop which primarily consisted of American experts in various oceanographic applications. A system to measure geochemical properties is discussed in [4h]. It is comprised of a buoy and anchoring system, an instrumentation module (which includes a subsurface geochemical sensor package for conductivity, temperature, pressure, pH, and redox potential), and a seafloor instrumentation package.

3.4.6.1 Temperature

Methods for obtaining subsurface temperature measurements (T_z) which have been tested have ranged from simple temperature sensors (such as thermistors imbedded in multiconductor cables) to data-collection modules reporting the temperature data via digital format. Other concepts which have been tried include profiling systems with instrument packages that would move up and down a vertical line, lines that were raised and lowered from a winch on the buoy deck, and automatic expendable bathythermograph launchers.

Another technique is an acoustic telemetry system in which a set of multiple subsurface units, attached to the mooring line at selected points, collect temperature and pressure data and transmit the information acoustically to a receiver on the buoy [31] .

Although thermistor lines for measuring temperature vertically at discrete depths have been in existence a long time and are generally regarded as state-of-the-art, many complex mechanical problems are created when they are used on data buoys in a harsh and dynamic ocean environment. The wave and wind interaction on the buoy causes extreme stress and strain on the Tz line. The almost constant motion of the buoy causes fatigue in the system components resulting in failure of the system. This motion-related strain is concentrated near the point where the electrical conductors transition from the moving buoy to the relatively fixed subsurface environment. A number of methods have been used to eliminate this failure point but limited success, at best, has been obtained for long-term deployments in severe weather areas. Methods of strain relief have been developed that limit the bending radius and provide survivability. An inductively coupled swivel system was used to allow the buoy to rotate without causing torsional stress on the conductors. Special designs of the conductor cables were developed and tested with some degree of success (periods of one year), but these special designs resulted in an expensive fabrication process and costly systems.

Various methods of attaching the Tz lines to the mooring have been tried:

- (a) The Tz line is physically tied to a stronger mooring line;
- (b) The Tz line is hung alongside the mooring line and held in place by loops at intervals along the mooring line;
- (c) An integrated line is used which has both the electrical conductors and mechanical strength member to moor the buoy in a single line.

The integrated line was considered the best candidate for deep-water application. Designs with Kevlar and steel strength members were developed. Another form of Tz line deployed is the hang-free line which has been found to be satisfactory to a depth of 50 meters.

Deep-water moorings, with thermistors to a depth of 300 metres, have been deployed by NDBC for up to a year in an unattended status [36]. The problems in servicing a 300-metre thermistor line at sea in a severe environment (such as the Gulf of Alaska) make the deployment difficult.

PMEL buoys along the Equator in TAO measure subsurface temperatures and currents. The sensor cable is strapped to the wire mooring with conventional wire rope clamps and extends 500 metres below the buoy. Data are processed, recorded, and transmitted via the Argos data acquisition system. The Finnish WEBOS buoy had a thermistor string and a hydrostatic pressure sensor [3].

3.4.6.2 Currents

Vector Averaging Current Meters (VACM) are routinely used on subsurface moorings and buoys to measure currents. VACMs are used in the TAO array; the current meter mooring at 0°, 165°E was equipped with VACMs at five or six depths in the upper 300 metres [19]. With a taut mooring, these measurements are satisfactory. However, in severe environments with high seas, taut moorings can cause stress in the upper mooring with resultant mooring failure. With an inverse-catenary mooring, movement of the buoy through the water while it transits around its watch circle may affect the accuracy of the current measurements. These movements may, at times, be relatively large because

deep-water moorings can have watch circle diameters of as much as six kilometres. Also, at the surface, errors are introduced by movement of the sensor through strongly sheared orbital motions.

WHOI chose Vector Measuring Current Meters (VMCMs) as primary velocity measuring instruments for a study due to their ability to measure the mean flow accurately in the presence of high-frequency surface waves and mooring motions [38]. Data from VMCMs, VACMs, and temperature sensors were obtained for up to 150 days.

An alternative method in use at NDBC is the Acoustic Doppler Current Profiler (ADCP) system, which is designed for use on moving vessels. The ADCP operates by transmitting short acoustic pulses into the water from a transducer, in this case mounted facing downward in a well through the hull. Backscattered sound from plankton, small particles, and small inhomogeneities in the water is received by the transducer with a Doppler frequency shift proportional to the relative velocity between the scatterers and the transducer. Time-series measurements produce profiles of water flow versus depth. Currents can be measured to a depth of 350 metres on a buoy with battery power.

A technique to provide measurements of surface currents is discussed in [3i]. The measurement is made by a sensor mounted rigidly beneath a wave-slope-following discus buoy with a diameter of 1.6 metres at a depth of one to two metres below the surface. An inverse-catenary mooring is used. The current sensor is of the electromagnetic type and is arranged symmetrically around the mooring attachment spar so as to maintain the sensor clear of mooring cables and to avoid sampling in the wake of the spar at any particular buoy orientation in steady flow.

3.4.7 Other sensors

3.4.7.1 Solar radiation

Measurements of solar radiation (in conjunction with humidity observations) were taken on coastal buoys off California for many years for the purpose of air quality studies. The solar radiation sensors were LI-COR Model-200Z pyranometers. The detector is a high-stability silicon photodiode that is housed in a weatherproof aluminium case. The sensor is not gimballed, which may introduce some errors. Evaluation of the observations was conducted on three sets of adjacent buoys and, in general, the sensors showed good agreement.

Japan uses cadmium sulphide or a solar cell as the sensing element (Annex II). WHOI has used Eppley pyranometers on buoys [39].

3.4.7.2 Humidity

As part of the West Coast air quality studies mentioned above, NDBC found the Rotronic hygrometer sensor, which is a capacitive polymer sensor, to be accurate and reliable enough to be operationally qualified on buoys. A report of a thorough test of humidity sensors by the Royal Netherlands Meteorological Institute confirmed the NDBC evaluations [22].

The humidity sensor used by the UKMO (the OCRC II) is a wafer of a chemically treated styrene copolymer that has an electrically conducting surface layer with an integral nonconducting substrate. Changes in relative humidity cause the surface resistivity to vary. To enable this sensor to remain operational for six months or more, a protective housing with a Gore-Tex screen was developed. The Gore-Tex shields allow passage of water vapour, but not of liquid water, and its teflon surface minimizes adhesion of salt crystals.

This is successful in all but the most severe sea conditions, and helps to delay the negative effects of salt contamination.

3.4.7.3 Precipitation

Efforts have been made at NDBC to develop a rain-gauge to install on a buoy. A few pre-prototype instrumentation experiments were conducted to determine what particular design features were most promising for further development. It was soon decided that a raingauge that can operate on a moving platform, like a buoy, should directly measure the volume and not the weight of the precipitation, as is done by the tipping-bucket design. NDBC tested 13 commercially available (R.M. Young) raingauges. Their construction and operation are based on the development efforts at NDBC. Total accumulation of precipitation before siphon-dump is five centimetres. Test results indicated the gauges were not accurate when rainfall rates were very light. Indirect observation of rainfall by measuring the ambient noise reverberation of rainfall on the surface is being studied.

This gauge detects optical irregularities (scintillations) produced by precipitation within a sample volume falling through a beam of infrared light. By detecting the intensity of the scintillations, precipitation rate can be determined.

3.5 Power systems

Early deployed buoys were powered by diesel generators. This power-generating capacity was required by the onboard electronics at that time. Other means such as nuclear power and wind generators were also used with varying degrees of success. With miniaturization and reduced power requirements of subsequent electronics and transmission equipment, use of batteries became commonplace. In the mid-1970s through the late 1980s, large quantities of primary (non-rechargeable) batteries provided most of the power for the systems. These batteries normally can power a buoy for approximately two years and then they have to be replaced. This can be a very difficult and hazardous operation at sea, so buoys are usually retrieved and recharged in port. There are disposal problems with batteries (such as air-depolarized lithium, and some alkaline types) because they contain toxic materials.

Photovoltaic (solar) systems are a dependable power source, even at high latitudes, and the number of primary batteries required has been significantly reduced. Normally, photovoltaic panels power rechargeable secondary batteries that directly drive the buoy systems. Thus, the solar power can replace or greatly supplement the all-battery power supply previously used on most buoys. However, photovoltaic panels may be damaged at sea or during buoy servicing, so a small number of primary batteries normally are still retained as a reserve supply until a service visit can be carried out.

The UKMO has in the past used air-depolarized primary cells and nickle-cadmium secondary cells. They proved to be reliable but were very heavy. Consequently, they are now employing sealed lead acid gel batteries charged by solar panels. Japan uses air-depolarized batteries as primary and alkaline batteries as secondary (Annex II).

In a recent project, NDBC is working with the U.S. Federal Aviation Administration (FAA) to develop and test a photovoltaic system capable of satisfying a sustained power demand of 800 watts. While this is being undertaken for a communications system, the lessons learned, if successful, might be applied to future remote environmental sensing systems that require large amounts of power.

3.6 Deployment procedures

Some Member buoy agencies are supported by their governments' ships and personnel in deploying and servicing buoys. Others use commercial groups for support. Close liaison is required between the buoy centre and the deploying vessel and crew.

Field service can be initiated and executed in accordance with Field Service Plans (FSPs). The FSP can define the nature of the work to be accomplished and include the necessary equipment lists, specific mooring diagrams, and logistics requirements. Information on the suspected causes of failures is also included, if available. FSPs should normally be prepared well in advance of a mission and provided to both field service personnel and the supporting vessel.

The ability to accomplish any mission is enhanced if all concerned have an understanding of what must be done. Briefings by buoy centre personnel prior to sailing are useful in planning the vessel's itinerary. Detailed briefings for shipboard personnel who will be assisting or actually doing the work can be given. A buoy training video tape can be provided to familiarize shipboard personnel in advance with equipment and operational procedures. Post-mission critiques are helpful to both ship and buoy personnel. By discussing events while they are fresh in everyone's mind, ways to improve techniques and enhance safety can often be discovered. Trip reports detailing mission occurrences provide valuable planning and technical information to the engineers and managers. The reports should include a description of the operation, as-deployed mooring diagrams, ground truth data sheets, configuration control, and damage reports. A Notice to Mariners must be promulgated upon the establishment or disestablishment of a buoy station.

Normally a buoy agency representative will accompany a vessel deploying, recovering, or servicing a buoy. The representative and other accompanying personnel are normally responsible for the following:

- (a) Assuring that all mooring components and support equipment are loaded aboard the ship as scheduled;
- (b) Providing all required service, repairs, or adjustments to the buoy, mooring, or payload as required;
- (c) Completing a thorough buoy inspection prior to the ship getting under way to assure the seaworthiness of the buoy;
- (e) Recommending proper deployment techniques to the captain of the vessel to reduce the risk of fouling the mooring in the propeller or damaging the buoy and its sensors;
- (f) Preparing a complete and accurate report of the operation including all pertinent test data and configuration control information, accurate documentation on the as-deployed mooring configuration, and any changes made to the existing mooring;
- (g) Assuring that safety of personnel is the primary factor controlling the operation.

After a buoy has been serviced, deployed, or established, it is necessary to verify its operation before releasing the data to users. This is normally accomplished through observation of environmental conditions at the site by the field personnel and then passing this information to the buoy centre for comparison with the data transmitted by the buoy. At least three hourly rounds of ground truth are usually required.

When a new buoy station has been established or a new mooring deployed, the exact position of the anchor needs to be determined. It usually takes 20 to 45 minutes for the buoy to settle on its mooring following release of the anchor. Each time ground truth is taken, the ship's position together with the range and bearing to the buoy are passed back to the centre. This information can be used along with buoy position-fixing systems to determine the position of the anchor for the *Notice to Mariners*.

It is helpful to have a field service manual, such as [35], to act as a primary source of information for matters relating to service of buoys. Areas covered can include descriptions of buoys, moorings, and payloads; towing, deployment, and recovery techniques; special circumstances and safety tips; and points of contact.

In addition to capsizing, there are other hazards that moored buoys face. Ships have collided with buoys, causing serious damage to the mast, sensors, and hulls. In some cases, collisions have actually caused buoys to sink by rupturing watertight compartments. Vandalism can occur, especially in coastal areas. This can happen through theft or damage to buoy components or by high-calibre gunfire which can penetrate the hull and cause sinking. A common danger is mooring failure caused by long-line fishing gear cutting moorings. Ships and boats may tie up to buoys for various reasons and this may affect the quality of measurement systems. Ice freezing on a buoy from spray or precipitation can cause listing or even capsizing. To minimize this, Finland constructed a buoy that minimizes the surface area to which ice can cling [4]. Nevertheless, in spite of all these dangers, data loss due to vandalism and collision is normally small.

3.7 Refurbishment

Buoys deployed in an ocean environment are affected by salt-water corrosion and marine biological fouling. On steel hulls and components, the corrosion can cause serious rust problems, and aluminum hulls are subject to pitting. All but the upper portions of moorings are normally sound for at least six years, and hulls can satisfactorily be maintained at sea for up to four years. However, battery-powered systems on board are normally only adequate for two to three years, and the buoy must be recovered to replace the batteries. When buoys are retrieved and returned to shore facilities, they are normally refurbished for the next deployment.

Hulls are usually refurbished by abrasive blasting, welding and repair processes, and repainting. The last phase of the hull refurbishment is the air pressure test which demonstrates that the hull structure and intercompartments meet watertight requirements. All of these operations are potentially hazardous, and NDBC considers that detailed, written specifications, procedures, and safety policies for each test are mandatory.

3.8 International buoyage system and other requirements

In 1982, most of the world's maritime nations participated in an agreement which implemented the International Association of Lighthouse Authorities (IALA) Maritime Buoyage System. This programme promotes safety of navigation by establishing a worldwide harmonious buoyage system. There are special sections regarding data buoys. ODAS are to be colored solid yellow. They are to display yellow (or white or amber) lights with fixed or slow flashing rhythm preferred.

4. OTHER ODAS

4.1 Background

A large percentage of the world's population is located in coastal areas and the number of people along the coast is steadily increasing. As discussed in the introduction, observations from marine sites are needed to identify developing severe weather situations that threaten life and property along the coast. Automation of Aid-to-Navigation (AtoN) facilities has reduced the number of observations taken by former stationkeepers.

A number of circumstances can occur that will provide more coastal weather reports. In addition to automated observing stations that may be erected for weather forecast and warning purposes, automated reports from oil drilling rigs and observations from special projects such as coastal erosion or environmental impact studies can increase the data coverage in coastal regions.

Sensors and electronic payloads at other ODAS fixed sites are usually similar to those used on buoys. Averaging times for wind measurement are shorter (usually two minutes) since buoy motion does not have to be considered. Additional parameters such as humidity, visibility, precipitation, and solar radiation can more easily be measured and maintained than on buoys. Also, wave measurements from wave staffs, bottom-mounted pressure sensors or infra-red laser wave height sensors; tide observations; and currents can be obtained at some stations.

Current measurements in coastal waters are needed for pollution studies, oil spills, and shipping. Automated real-time current observations are made at coastal locations in Sweden [3e]. One technique used is a bottom-mounted pole with the current meter at the top. Another method used is a bottom-mounted ADCP in combination with an inverted echosounder for wave measurements.

The marine data system for the seas contiguous to Norway, which was prompted by the development of the offshore oil industry, is discussed in [12]. Most rigs and platforms are required by Norwegian law to carry out measurement programmes recommended by the national Meteorological Service.

Germany operates a coastal maritime measuring network. Observations are taken on unmanned lightships and lighthouses. Iceland installs automatic weather stations on lighthouses with real-time data available via an automated call-up voice information system.

The Netherlands marine network consists of seven oil rigs and fixed platforms, five of which are offshore. One station reports via satellite, the others through dedicated lines. Both station location and instrument exposure have been optimized as much as possible, and the primary purpose is to support operational forecasting. Temperature, humidity, wind, visibility, and atmospheric pressure are provided.

The UKMO maintains a network of 16 other ODAS on unmanned light vessels, remote islands, oil and gas platforms and a navigation beacon.

4.2 Types of station

4.2.1 Coastal

Some locations may be remote and require batteries, wind generators, or photovoltaic panels to power the station. Others may have access to commercial power and telephone lines. In these cases, payloads can be utilized that make more frequent

observations, and telephone access can allow forecasters to dial in to the latest measurements, which may be needed in developing weather situations.

Unattended automated land stations are subject to vandalism. Chain-link fences offer some protection. Some sites, such as lighthouses, have become national historical monuments, and procedures have to be followed in consonance with pertinent regulations. Other stations may be located in wildlife refuges requiring adherence to certain procedures.

Well-exposed coastal sites provide observations that are more representative of marine conditions than stations that are only slightly inland. Evidently, the frictional effects of land and vegetation reduce the wind speeds considerably at locations just a few kilometres inland. This effect is documented in [8]. Canada found that one of the difficulties with coastal stations is in obtaining observations that are representative of conditions over the open water [4f]. The topic of wind measurements near the coast is discussed in [14]. NDBC calculates the height of the boundary layer to optimize placement of anemometers. Coastal locations are normally subject to more extreme temperature conditions than the open ocean. Consequently, automated instruments may report erroneous measurements as a result of freezing situations.

- (a) **Lighthouses:** A typical lighthouse that has had the Aid-to-Navigation facilities automated is shown in Figure 6, which is an NDBC Coastal-Marine Automated Network (C-MAN) station at Dunkirk, New York. The best exposure for anemometers is usually found to be above the lighthouse. However, this location may be at a considerable elevation above the water level. As wind speed is normally greater at higher elevations, strong measured winds at these heights reported to mariners may lead to misunderstandings when no surface wind warnings are in effect;
- (b) **Headland stations:** These may include light stations, beach areas, and fishing piers. Agreements may have to be worked out with city or other governmental agencies. Localities tend to take pride in their "own" weather station. For installation of new platforms, a tower is normally constructed with the anemometers at the top of the mast at 10 metres as shown in Figure 7, the C-MAN station at Venice, Florida.

Finland has automatic marine weather stations on lighthouses. In addition to the standard parameters, humidity, rain on/off, and total radiation are also measured. The collection and recording of the observations are made at three-hour intervals via teletype or telephone lines. The minicomputer in the central station converts the raw data into physical units and tests them with rough limit values. The information moves to the message device in the form of synoptic messages, and then they are transmitted onto the GTS, to the central computer, and then to storage. For further information on the stations and use of the data, see [3b].

4.2.2 *Offshore oil rigs*

Oil company and other operator attempts to provide automated weather reports from oil drilling platforms have been plagued with problems of maintenance, transmission, and quality control. When incorporated into a national programme with reliable communications, and processing and quality control at appropriate centres, the data are invaluable to the oil companies and forecasting agencies. Special considerations are obstructions to free flow about the rig and high elevation of the anemometers. Frequently, wave spectra data tend to be held proprietary by oil companies.

4.2.3 Island stations

Automated platforms on islands tend to be similar to coastal stations. Allowances for obstructions such as trees have to be made in siting the installation. Platforms in some locations may be near the limit of reception coverage for geostationary satellites. An example is Faraulep Island at 8.6°N, 144.6°E in the Carolines (Figure 8), which was the first station of an expanding network in the Western Pacific. At Faraulep, the antenna elevation angle for GOES satellite transmission was near zero; however, complete and accurate transmissions were accomplished until this coastal station was destroyed during a typhoon. A cooperative agreement between the U.S. and Japan has permitted data from stations even farther west to transmit hourly via JMA's GMS on to the GTS. At very remote locations like Faraulep, logistics and maintenance support are difficult.

4.2.4 Aid-to-Navigation (AtoN) buoys

Some lightships which marked the entrances to harbors and channels have been replaced by navigational buoys and weather observations have been lost. At other places where AtoN buoys are located, weather and sea condition reports are critical. Therefore, it is important to instrument these buoys. AtoN buoys tend to be very active in the water. This makes servicing the buoy very difficult from a ship. Buoys and instruments have been badly damaged while a ship was alongside. Nevertheless, measurements from AtoN buoys have been found to be accurate and useful.

5. DATA MANAGEMENT

5.1 Data flow

Although data from some buoy and other ODAS are transmitted by HF or line-of-sight UHF links to shore, most reports are now sent via geostationary or polar-orbiting satellites. Transmission via geostationary satellites, such as the US GOES, the European METEOSAT, and the Japan Geostationary Meteorological Satellite (GMS), requires more power than systems that transmit via polar orbiting satellites, such as the US POES/Service Argos system. For example, NDBC's moored buoys use 40 watts, and fixed stations use 10 watts transmitters to report via GOES; Japan requires 20 watts power to transmit from its buoys via the GMS; and the UKMO has found 25 watts to be sufficient even for latitudes greater than 59°. By contrast, countries whose buoys report via Service Argos operate transmitters using 1 watt or less. Messages with a larger data content can be sent on a more regular basis (*e.g.* hourly or synoptic hours) through geostationary satellites as they are always in view. In the case of polar-orbiting satellites, data can only be received on the ground with no delay when the transmitter and receiver are simultaneously within line of sight; otherwise, data are stored aboard the satellite for later play-back. Polar-orbiting satellites offer the capability, through Service Argos or Local User Terminals (LUTs), of position determination. Recently, Global Positioning Systems (GPS) aboard buoys have become cost effective enough for use with either geostationary or polar-orbiting satellites to provide location; the use of GPS is growing dramatically.

Systems that determine position are important for moored buoys that go adrift. Notices to Mariners can be disseminated and positions can be given to retrieval vessels. Some Members' programmes use redundant communication and position-fixing systems, such as LORAN, to ensure reliable backup capability.

5.2 Shoreside processing

Most data are transmitted in a standard character code so that the observations can be put immediately on communication circuits. Others use pseudo-character formats that have to be processed at meteorological processing or communications centres. The pseudo formats are used for nondirectional and directional wave data and other data that require additional processing or occasional changes to processing algorithms and to enable selection of the more reliable sensor data from duplicate systems. Regardless of the format, the reports need to be expeditiously disseminated. WMO procedures, such as in [42], call for observational data to be handled rapidly during preprocessing by the global data-processing system and during transmission over the GTS.

Data from JMA buoys are transmitted via the GMS to the Meteorological Satellite Centre (MSC). Since a message is sent twice at each transmission, the two messages are checked and the more reasonable one is selected. At the MSC the message is decoded and converted to WMO FM 13-IX SHIP (report from a sea station), FM 63 BATHY, and a domestic format containing whole observational elements. These are then sent by landline to JMA headquarters. SHIP and BATHY reports are disseminated to domestic and foreign meteorological offices. Domestic reports are archived after quality checks (Annex II).

Data processed by Service Argos are described in [46] and are normally disseminated over the GTS in FM 18 BUOY, FM 13 SHIP and FM 63 BATHY code format [43].

In an attempt to help marine forecasters and modelers, the U.S. transmits, in Section 5 of FM13 SHIP code, wind values extrapolated to 10 m and 20 m. The values are derived from measured wind speed, air temperature, and sea surface temperature. This is also done for all C-MAN observations.

5.3 Quality control

Reference [43] discusses real-time quality control of observational data and provides the following guidelines. The primary responsibility for quality control should rest with the national Meteorological Service from which the observation originated. Members should make adequate provision for quality control of their national meteorological observations with a view to ensuring that when these observations enter the GTS they are as free from error as possible. Quality control of the data needed for real-time uses shall not introduce any significant delay in the onward transmission of the data over the GTS.

These guidelines require that real-time quality control checks be automated and validate the data *on the fly*. This means that gross error checks, such as range limits based on climatological or other extremes and time-continuity bounds for sequential observations, are about the only tests that can be applied. Even these have to be applied with caution (*e.g.* data from stations in the path of a tropical cyclone may exceed time-continuity limits but still be valid). In the US the real-time quality-control-checks are performed at the National Weather Service Telecommunications Gateway (NWSTG).

All Argos data are subjected to gross range limit error checks during Service Argos processing. Data received through LUTs and entered operationally onto the GTS by the LUT operator should undergo quality control by the relevant Meteorological Service.

These real-time checks are very effective at removing the large errors caused by intermittent data transmission problems and the data from obviously failed sensors. These errors typically account for 0.5 per cent data loss, and the checks remove over 90 per cent

of these errors. On the other hand, these checks do a poor job of detecting errors caused by sensor degradation. Examples of sensor degradation include cases where pressure drops due to ice accretion, or measurements change because of sensor drift, or the wind speed reports too low because of worn anemometer bearings. Only about 25 per cent of these problems are caught by the real-time checks, yet such problems cause persistently bad data. In order to remove these bad data from distribution, more stringent quality control needs to be performed in a near- or non-real-time sense, normally within 24 hours. When sensor deficiencies are detected, a status file on the processing or communications computer can be updated to withhold release of or modify that sensor's data. A description of quality control of data from automated marine stations can be found in [4d] and [10].

When a bias due to sensor degradation is detected, modifying the data may improve the delivery of accurate data to operational forecasters. However, there are some agencies that prefer to see the original, unmodified report for their own purposes. The WMO Commission for Basic Systems has adopted the code FM 94-IX BUFR, which is a bit-oriented code for the efficient representation, exchange, and storage of observational data. When BUFR is fully implemented, it will allow the transmission of the observed value, as well as any suggested modifications.

At JMA, data quality is not assessed for SHIP and BATHY reports before insertion onto the GTS. Buoy data quality is monitored during the analysis of weather charts, including plotted buoy reports. Then, experts review all erroneous or questionable data to determine the source of the error. Once an error and its cause have been identified, all subsequent data for the element found to be in error are eliminated or adjusted prior to being coded into SHIP/BATHY reports. Stringent range checks and time-continuity checks are applied to all data before they are archived. Erroneous data are deleted or corrected. Processed and edited data are published annually as *Data from Ocean Data Buoy Stations*. They are also archived on magnetic tape at the Oceanographical Division in JMA headquarters (Annex II).

First guess analysis fields calculated at numerical centres are a powerful tool in detecting consistent errors from reporting stations. Monthly statistics computed at the European Centre for Medium-range Weather Forecasts, the UKMO, and the US National Center for Environmental Prediction (NCEP) are a big help in identifying errant stations.

Canada, which has three buoy centers, runs limited automatic data quality checks using a system called WBS. WBS controls which data are released, performs range limit checks, adjusts pressures where necessary, and permits re-scaling [2].

In the Netherlands, quality control is by the Maritime Meteorological Department, and archival is performed in DeBilt [Annex II]. One station transmits through METEOSAT; the remainder transmit by dedicated line.

Data quality improved significantly from both moored and drifting buoys with the trial implementation of an electronic bulletin board on Omnet in early 1992. The decision to implement the bulletin board, named **BUOY.QC**, on a trial basis was made at the seventh session of the DBCP [41]. The system was switched to the Internet in late 1994 with the valuable support of the Icelandic Meteorological Office. The system is managed by the Technical Coordinator of the DBCP, and includes several Principal Meteorological or Oceanographic Centers (PMOC) which post quality control messages in a standardized format. The messages are accessed by individuals or groups registered on the list, and corrections or changes may be authorized by owners of the platforms.

6. CONCLUSIONS / RECOMMENDATIONS

National data buoy and ODAS programmes have developed and matured to the point where high-quality real-time environmental observations are routinely taken from automated unattended stations in data-sparse marine areas. These reports complement satellite and ship observations and provide the best set of continuous time-series data from a single location in the marine environment.

The growth of the networks has come about largely through the increased dependability and miniaturization of electronics (which reduce costs), improved reliability of mooring systems, and the emergence of alternative power sources and satellite communications capabilities. The increase in the number of platforms and the enhanced dependability of the deployed systems have occurred in the same time period that has seen a tremendous expansion in the amount of coastal and offshore marine activity. There has also been a large increase in the population of coastal areas. With the growth of marine activity and coastal habitation, there has been a vital need for increased observations. The expansion of data buoy and ODAS networks reflect this requirement.

Since the value of buoys and ODAS is apparent and as more countries are deploying such platforms, a clear need exists to provide and share information about these programmes. This Guide attempts to be that vehicle.

Many problems yet exist. Although much improved over the past, there are still numerous failures of mooring, power, electronics, and sensor systems. However, that stations can operate unattended in a harsh marine environment and transmit good data for a year or two with minimal servicing, is quite remarkable.

Recommendations for consideration of Members can be listed as follows:

1. Continue to work for improved reliability of all components of deployed systems.
2. Promote the development and deployment of new and improved sensors to measure marine environmental parameters that are not presently reported.
3. Install dual anemometers at remote sites. Anemometers are one of the most critical components at remote automated stations, in terms of both importance of the measurements and maintainability of the instruments. Dual anemometers at platforms increase initial and maintenance expenses, but in the long term are cost effective. If an anemometer fails, the redundant sensor can continue to provide data without an immediate high priority costly service visit to repair it. Also, the comparison of data from side-by-side anemometers is the best quality-control tool available
4. Educate users on the validity of buoy winds. Many marine forecasters believe that buoy winds are too light in comparison with ship winds. Studies have shown that buoy winds appear lower because of longer averaging times and lower anemometer heights than ships.
5. Continue to improve the quality-control level of real-time and near-real-time data; publicize and encourage use of the electronic QC system. Poor quality data is a serious data assimilation problem for numerical weather prediction and adversely affects the accuracy of forecasts. Bad archived data can impact marine research studies.

- 6. Foster the international exchange of buoy and ODAS technology information by such means as the COST 43 and Marine Technology Society conferences.**
- 7. Move toward international standardization of measurement techniques such as sampling frequencies, sampling intervals, and averaging periods.**

FIGURES

- Figure 1 - Navy NOMAD buoy**
- Figure 2 - 10-metre discus buoy during servicing**
- Figure 3 - Standard mooring systems used by NDBC**
- Figure 4 - Types of anchors**
- Figure 5 - NDBC 3-metre hull with large wind fin attached to the mast structure**
- Figure 6 - Dunkirk Light, New York, one location where C-MAN equipment is installed**
- Figure 7 - Venice, Florida, one location where C-MAN equipment is installed**
- Figure 8 - Remote C-MAN station at Faraulep Island**





NDBC STANDARD MOORING SYSTEMS

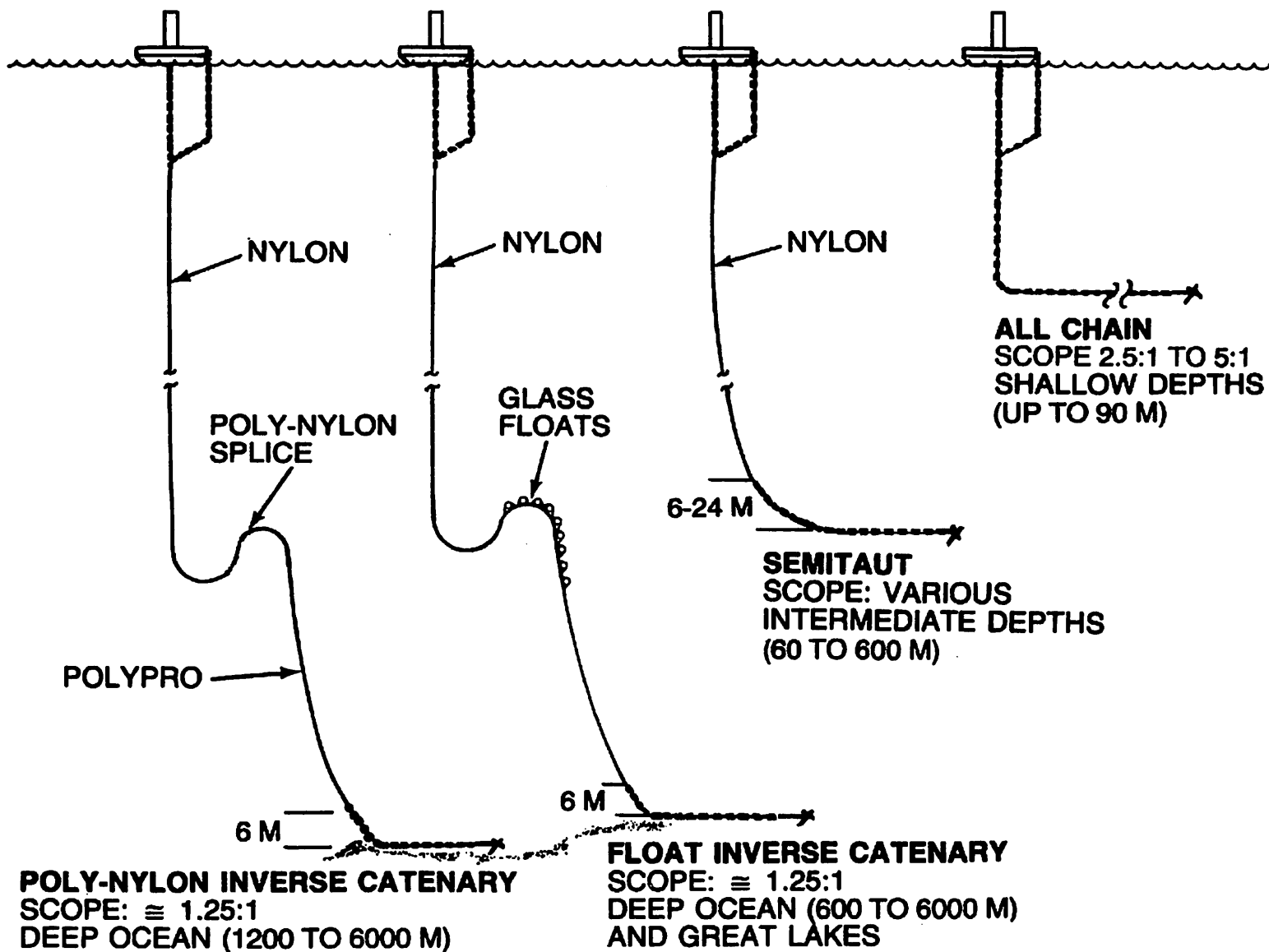

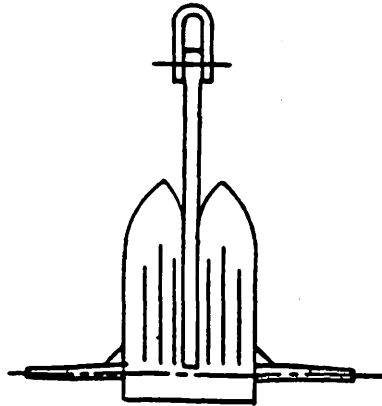

STATO/12:1 (MUD)
20:1 (SAND)

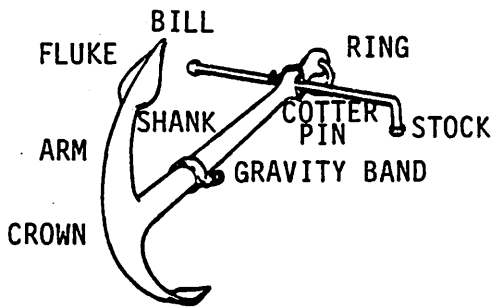

FISHERMAN'S (KEDGE)/5:1

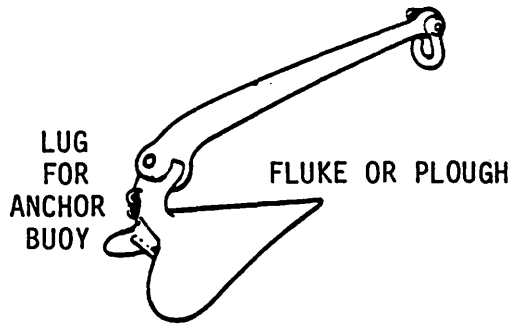

CQR (PLOW)/8:1

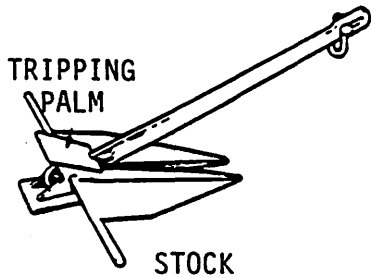

DANFORTH/10:1 (MUD)
18:1 (SAND)

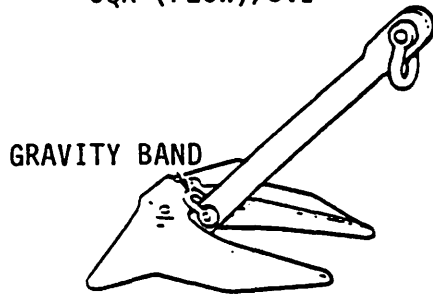

STOCKLESS/6:1



CHAIN 3/4:1

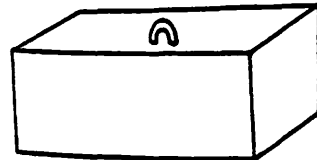

CONCRETE 1/2:1

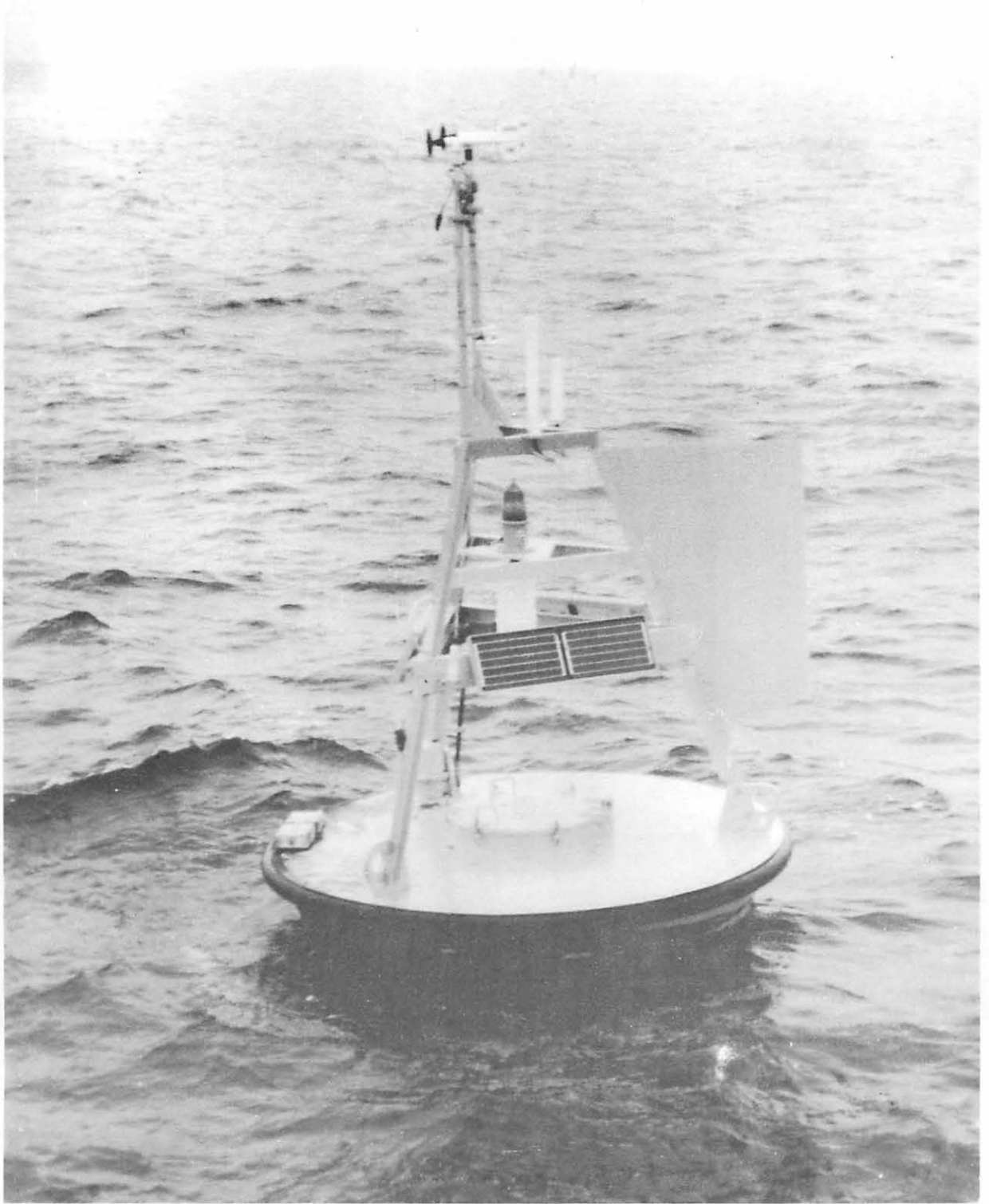





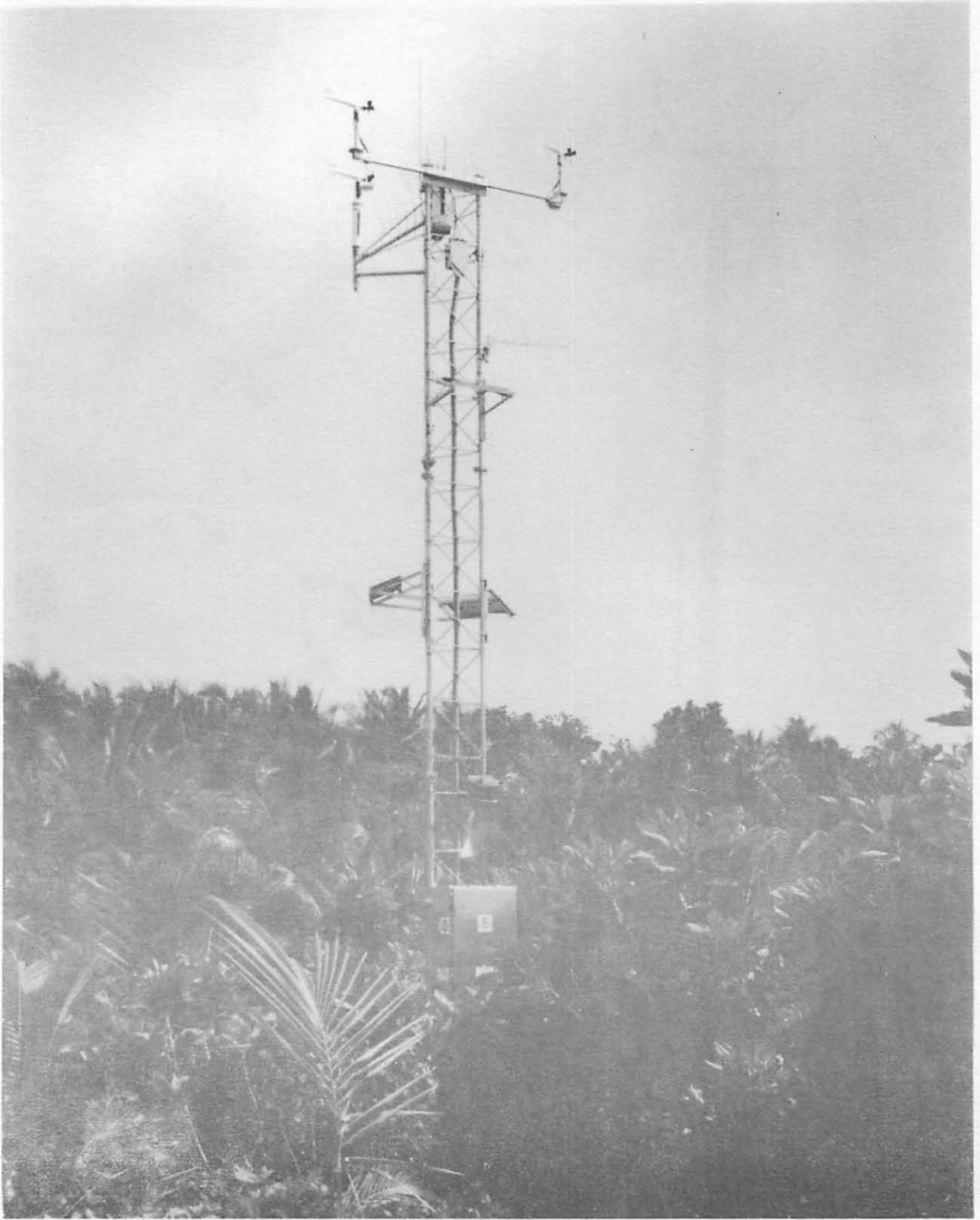

ANNEX I

REFERENCES

1. Allender, J., Audunson, T., Barstow, S. F., Bjerken, S., Krogstad, H. E., Steinbakke, P., Vartdal, L., Borgman, L. E., and Graham, C., 1989: The WADIC Project: A Comprehensive Field Evaluation of Directional Wave Instrumentation. *Ocean Engineering*, Vol. 16, No. 5/6.
2. Axys Environmental Consulting Ltd., 1996: *Meteorological and Oceanographic Measurements from Canadian Weather Buoys (Final Report)*.
3. Bentley A.N., and Imes D.W., 1993: Development of the UK Meteorological Office's Open Ocean Data Buoy. *Proceedings 2nd Data Collection System User's Conference, Athens*
4. Commission of the European Communities, 1987: *Proceedings, Seminar on Operational Ocean Station Networks COST Project 43, Brest, France, 16-18 June 1987*
 - a. Rolland, J., Blouch, P., and Fusey, F. X., A French-United Kingdom Experiment to Moor a Meteorological Data Buoy in a Deep Sea Area.
 - b. Gronvall, H. and Kalliosaari, S., Some Weather Characteristics at the Finnish Automatic Marine Weather Stations.
 - c. Dexter, P. E. and Treglos, Y., WMO and IOC Programme Requirements for Operational Ocean Station Data.
 - d. Gilhousen, D. B., Data Quality at the National Data Buoy Center.
 - e. Mattison, I., Experience from Current Measurements in Real Time.
 - f. Wells, G. E., Marine Data Acquisition Systems - Canada.
 - g. Bentley, A. N., Brettle, M. J., and Bedford-Smith, J., Operational Experience with the ODAS 20 Data Buoy.
 - h. Murray, C. N. and Weydert, M., Design and Construction of a Deep Ocean Data Operating System.
 - i. Collar, P. G., Hunter, C. A., and Perrett, J. R., Near-Real Time Measurement of Surface Currents Using a Small Buoy.
 - j. Korhonen, O., WEBOS, a New Meteorological and Oceanographical Data Buoy.
 - k. Salonen, K., Hydro-Meteorological Data Buoy with Knowledge-Based Supervision System.
 - l. Stromme, J. A., Fixed Moored Meteorological Data Buoys ODAS-451/452.
5. COST-43 Proceedings of Seminar on ODAS Related Technical Topics, Bergen, Norway, Sep., 1980
6. Dobson, F., Hasse L., and Davis R.(Ed.), 1980: *Air-sea Interaction Instruments and Methods*. Plenum Press, New York.
7. Ezraty, R. and Racape, J. F., 1986: Directional and Omnidirectional Information Obtained from Instrumented Buoys. *Proceedings, Marine Data Systems '86, Marine Technology Society*.
8. Gilhousen, D. B., 1986: NDBC Tropical Storm Observations. *Mariners Weather Log*, Vol. 30, No. 1, National Oceanic and Atmospheric Administration.
9. Gilhousen, D. B., 1987: A Field Evaluation of NDBC Moored Buoy Winds. *Journal of Atmospheric and Oceanic Technology*, Vol. 4, No. 1.

ANNEX I-2

10. Gilhousen, D. B., 1988: Quality Control of Meteorological Data from Automated Marine Stations. Preprint volume. Fourth International Conference on Interactive Information and Processing Systems for Meteorology, Oceanography and Hydrology, 31 Jan.-5 Feb. 1988, Anaheim, Calif. Published by the American Meteorological Society, Boston, Mass.
11. Gilhousen, D. B., 1990: NDBC Directional Wave Measurements. Proceedings, Marine Instrumentation '90, Marine Technology Society.
12. Guddal, J. and Bjorheim, K., 1986: Description of the Marine Data System Designed for Forecasting Purposes in the NE-Atlantic Adjacent Basins. Proceedings, Marine Data Systems '86, Marine Technology Society.
13. Hamilton, G. D., 1988: Small Coastal Data Buoys. Proceedings of the Fourth Conference on Meteorology of the Coastal Zone, 31 Jan.-5 Feb. 1988, Anaheim, Calif. Published by the American Meteorological Society, Boston, Mass.
14. Hsu, S. A., 1988: Coastal Meteorology. Academic Press Incorporated, San Diego, Calif. 260pp.
15. Jones, D.W., Bentley, A.N., 1993: Experience with METEOSAT Data Collection Platforms and PTTs in UK Meteorological Office Open Ocean Buoys, Proceedings 2nd Data Collection System User's Conference, Athens.
16. Le Blond, P. H., 1984: Final Report of the Investigation on the Storm of October 11-12, 1984 on the West Coast of Vancouver Island. Submitted to the Minister of the Environment, House of Commons, Ottawa, Ontario on November 30, 1984.
17. Mangum, L. J., Freitag, H. P. and McPhaden, M. S., 1994: TOGA-TAO Array Sampling Schemes and Sensor Evaluations. Proceedings of the Oceans '94 OSATES, Brest, France.
18. McPhaden, M. J., 1995: The Tropical Atmosphere Ocean Array is Completed. Bulletin of the American Meteorological Society, Vol. 76, No. 5.
19. McPhaden, M. J., Hayes, S. P., and Mangum, L. J., 1990: Variability in the Western Equatorial Pacific Ocean during the 1986-87 El Niño/Southern Oscillation Event. Journal of Physical Oceanography, Vol. 20, No. 2.
20. Michelena, E. D. and Holmes, J. F., 1986: The Meteorological and Oceanographic Sensors Used by the National Data Buoy Center. Proceedings, Marine Data Systems '86, Marine Technology Society.
21. Milburn, H. B. and McLain, P. D., 1986: ATLAS - A Low Cost Satellite Data Telemetry Mooring Developed for NOAA's Climate Research Mission. Proceedings, Marine Data Systems '86, Marine Technology Society.
22. Muller, S. H. and Beekman, P. J., 1987: A Test of Commercial Humidity Sensors for Use at Automatic Weather Stations. Journal of Atmospheric and Oceanic Technology, Vol. 4, No. 4.
23. National Oceanic and Atmospheric Administration and National Science Foundation, 1976: Ocean Profiling Workshop.

ANNEX I-3

24. Painting, D. J., 1986: Development of an Operational Moored Buoy Network. Proceedings, Marine Data Systems '86, Marine Technology Society.
25. Pierson, W. J., 1990: Examples of, Reasons for, and Consequences of the Poor Quality of Wind Data from Ships for the Marine Boundary Layer: Implications for Remote Sensing. *Journal of Geophysical Research*, Vol. 95, No. C8.
26. Steele, K. E., and Earle, M. D., 1991: Directional Ocean Wave Spectra Using Buoy Azimuth, Pitch, and Roll Derived from Magnetic Field Components. *IEEE Journal of Oceanic Engineering*, Vol. 16, No. 4.
27. Steele, K. E., Lau, J. C., and Hsu, Y. L., 1985: Theory and Application of Calibration Techniques for an NDBC Directional Wave Measurements Buoy. *IEEE Journal of Oceanic Engineering*, Vol. OE-10, No. 4.
28. Stromme, J., 1978: The Norwegian Data Buoy Programme and the Contribution to COST-43, Proceedings of COST-43 Seminar, Lisbon, Portugal, 4-6 December 1978.
29. Teng, C.-C., and Timpe, G., 1994: Analysis and Testing of Ocean Buoys. Conference Proceedings MTS 94, Marine Technology Society.
30. Timpe, G. E., and Van de Voorde, N. E., 1995: NOMAD Buoys: An Overview of 40 Years of Use. Conference Proceedings Oceans '95 MTS/IEEE, San Diego, CA.
31. Towles, L. T. and Hauser, C. H., 1986: ATZ-An Acoustic Telemetry System for Collection of Subsurface Temperature Data from a Moored Buoy. Proceedings, Marine Data Systems '86, Marine Technology Society.
32. Unesco, 1972: Preparatory Conference of Governmental Experts to Formulate a Draft Convention on the Legal Status of ODAS (Paris, 31 Jan.-11 Feb. 1972).
33. Unesco, 1988: Guide to Drifting Data Buoys. IOC Manuals and Guides No. 20.
34. U.S. Department of Commerce/National Oceanic and Atmospheric Administration/National Data Buoy Center, (in press): NDBC Buoy Workshop 1993.
35. U.S. Department of Commerce/National Oceanic and Atmospheric Administration/National Data Buoy Center, 1987: NDBC Field Service Manual.
36. U.S. Department of Commerce/National Oceanic and National Data Buoy Center, 1986: NDBC Tz Program History.
37. Walz, M. A., Boy, R. L. Jr., and May, D. R., 1989: NDBC Mooring Design Manual, U.S. Department of Commerce/ National Oceanic and Atmospheric Administration/National Data Buoy Center.
38. Weller, R. A., Rudnick, D. L., Pennington, N. J., Trask, R. P., and Valdes, J. R., 1990: Measuring Upper Ocean Variability from an Array of Surface Moorings in the Subtropical Convergence Zone. *Journal of Atmospheric and Oceanic Technology*, Vol. 7, No. 1.
39. Weller, R. A., Rudnick, D. L., Payne, R. E., Dean, J. P., Pennington, N. J., and Trask, R. P., 1990: Measuring Near-Surface Meteorology over the Ocean from an Array of Surface Moorings in the Subtropical Convergence Zone. *Journal of Atmospheric and Oceanic Technology*, Vol. 7, No. 1.

ANNEX I-4

40. Wilkerson, J. C. and Earle, M. D., 1990: A Study of Differences Between Environmental Reports by Ships in the Voluntary Observing Programme and Measurements from National Oceanic and Atmospheric Administration (NOAA) Buoys. *Journal of Geophysical Research*, Vol. 95, No. C3.
41. World Meteorological Organization/International Oceanographic Commission, 1991: Report of the Seventh Session of the Drifting Buoy Co-Operation Panel.
42. World Meteorological Organization, 1977: Manual on the Global Data-processing System, Vol. I. WMO-No. 485, WMO Geneva.
43. World Meteorological Organization, 1983: Guide to Meteorological Instruments and Methods of Observation. WMO-No. 8, WMO, Geneva.
44. World Meteorological Organization, 1987: Some General Considerations and Specific Examples in the Design of Algorithms for Synoptic Automatic Weather Stations. Instruments and Observing Methods Report No. 19, WMO/TD-No. 230, WMO, Geneva.
45. World Meteorological Organization/International Oceanographic Commission, 1995: Reference Guide to the GTS Sub-system of the Argos Processing System. Data Buoy Cooperation Panel Technical Document No. 2.
46. World Meteorological Organization/International Oceanographic Commission, 1995: Guide to Data Collection and Location Services using Service Argos. Data Buoy Cooperation Panel Technical Document No. 3.

ANNEX II

MEMBER COUNTRIES' BUOY PROGRAMMES

The information in this annex was provided by representatives from several countries. The rapporteur wishes to express special appreciation to the individuals who provided information.

Australia	G. W. Jones (Bureau of Meteorology)
Brazil *	Dr. Merritt R. Stevenson (Instituto Nacional de Pesquisas Espaciais)
Canada *	Ron McLaren (Environment Canada)
France	Pierre Blouch (Centre de Meteorologie Marine)
Germany *	U. Gartner (Deutsche Wetterdienst)
Iceland *	Gisli Viggosson (Icelandic Lighthouse and Harbour Authority)
Israel *	Dr. Matti Weiss (Israel Meteorological Service)
Japan *	Koichi Nagsaka (Japan Meteorological Agency)
The Netherlands *	Frank Grooters
United Kingdom *	D. W. Jones (UK Met Office)
United States of America	*Julie Thomas (Scripps Institution of Oceanography) Linda Mangum (Pacific Marine Environmental Laboratory/ NOAA)

* All or a substantial part of the original report is reproduced.

AUSTRALIA

1. Introduction and historical overview

A requirement existed for the monitoring of atmospheric pressure and sea surface temperature in the early detection of tropical development in the Gulf of Carpentaria. An experiment was begun in 1992 to determine whether standard drifting buoys used in the First GARP Global Experiment (FGGE) and the Tropical Ocean Global Atmosphere (TOGA) programmes might be operated successfully as moored systems in shallow water (approximately 60 m).

In general, the experiment was successful. The small moored buoys operated from 9 to 15 months and were effective in monitoring. However, severe storms caused the buoys to drag anchor a significant distance on a few occasions. As a result of the success, Bureau of Meteorology policy is now to maintain at least one operational moored drifter in the Gulf. Recently, a Wind Speed/Direction (WSD) buoy has been moored with a modified mooring that includes a swivel at the bottom of the hull to allow measurement of wind direction.

2. Moored buoys

(a) *Hull description*

- aluminum spar approximately 3.5m long and 10cm wide, with 69.0cm frustum-shaped flotation collar.
- weight is approximately 100kg.

(b) *Mooring*

- type: 25mm 3-strand nylon line
- design: taut "soft" mooring consisting of 100 m weighted line drogue with 45kg of 25mm ship anchor chain on the bottom in approximately 60m depth.

(c) *Power systems*

- standard FGGE/TOGA type using D-cell batteries

(d) *Electronics payload*

- standard FGGE/TOGA-type drifting buoy payload

(e) *Sensors*

- standard FGGE/TOGA-type sensors, except Savonius rotor and fin assembly attached to the antenna to measure winds.

(f) *Deployment procedures*

- buoy and deployment pallet assembly are lowered by crane or slid over the side of the ship into the water. Pallet is released automatically when salt tablets dissolve. Exhausted buoys are not normally recovered for reasons of economy.

BRAZIL

1. Introduction and historical overview

In the early 1980s, Brazil recognized the need for a modest buoy program that would use both moored and drifting buoys. The first moored buoy prototype was developed in 1984 at the National Institute for Space Research (INPE). The development and use of a small number of moored buoys in the vicinity of the Antarctic peninsula was supported by the National Program for Antarctic Research (PROANTAR) through the Interministerial Commission for Marine Resources and the National Council for Scientific and Technological Development.

A private university began a development project in early 1993 to address Brazil's need for a larger and more sophisticated buoy that could be anchored in deep water. As of 1996, limited tests have been made with this buoy in shallow water and development is continuing.

Brazil's moored buoys are used for studies and research projects.

2. Moored buoys

(a) *Hull description*

(i) Bi-conic buoy

- Shape: bi-conic, with major cone submerged in water; sensor tower may use aerovane, have a "T" shape or simply be a vertical mast when used to support solar panels
- Size: 1.8m height x 80cm at largest diameter near water line
- Weight: 110kg displacement in water, requires additional stabilizing ballast of 100kg beneath buoy
- Composition: fiber glass, using sandwich technology for the hull; tower fabricated in fiber glass

(ii) Toroid buoy

- Shape: toroid
- Size: 2.30m external diameter x 85cm diameter for flotation; the 2.40m tall tower extends about 2.7m above the mean water line
- Weight: approximately 750kg, including tower and anchoring frame beneath toroid; 2000+ kg reserve buoyancy for mooring purposes
- Composition: toroid made of fiberglass, filled with syntactic foam and reinforced with steel bands, sensor tower made of corrosion resistant aluminum. The payload enclosure is a fiberglass cylinder located in the center of the toroid.

(b) *Moorings*

(i) Bi-conic buoy

- Type: flexible steel cable in upper part of mooring, synthetic (buoyant) cable in lower part and chain at the bottom, depending on mooring depth. For shallow water steel cable and chain are used.
- Design: semi-taut or inverse catenary, depending upon water depth; depths of moorings from 40m to 1000m have been used
- Anchors: railroad wheels stacked on a heavy steel pipe

(ii) Toroid buoy

- Type: flexible steel cable in upper part of mooring, synthetic (buoyant) cable in lower part and chain at the bottom, depending on mooring depth. For shallow water steel cable and chair are used.

ANNEX II - 4

- Design: semi-taut or inverse catenary, depending upon water depth; depths of moorings can be from 40m to deep sea depths
- Anchors: railroad wheels stacked on a heavy steel pipe

(c) *Power systems*

(i) Bi-conic buoy

- Batteries: have used stacks of alkaline D cells and also sealed rechargeable batteries
- Solar: 4 solar panels on bi-conic buoys with rechargeable batteries

(ii) Toroid buoy

- Batteries: sealed rechargeable batteries
- Solar: 4 solar panels mounted on tower

(d) *Electronics payload*

(i) Bi-conic buoy

- Microprocessor type and capability: none used with bi-conic buoys
- Components: custom designed analogic, sensor power supply and signal conditioning boards, INPE designed PCDs initially used, followed by commercially supplied PCDs. More recent buoys transmit up to 16 data channels, using 8 channels per transmission multiplexed, simultaneous data acquisition and transmission (401.65mhz) via Polar-orbiting Operational Environmental Satellites (POES) and CLS Service Argos.

(ii) Toroid buoy

- Microprocessor used with pre-deployment programming capability for data acquisition at specifiable time intervals. In normal operation, data are sampled during 6 minute intervals, 10 times per hour. Mean (hourly) values are determined, stored aboard the buoy and transmitted during each transmission. A carousel approach is used to ensure that there are a minimum number of data voids in the data received at Service Argos.
- Components: custom designed analogic, sensor power supply and signal conditioning boards, commercially available PCDs used. The buoy can presently transmit 24 data channels, although the capacity will be increased to the maximum 32 channels in the near future.

(e) *Sensors*

(i) Bi-conic buoy

- Wind: Some Brazilian made cup anemometers used with aerovane on buoy; R.M. Young anemometers.
- Pressure: Brazilian made atmospheric pressure sensors.
- Temperature: thermistors and platinum RTDs used for sea and air temperatures.
- Meteorological sensors located 2-2.25m above mean water line of buoy.

(ii) Toroid buoy

- Wind: 1-2 R. M. Young anemometers.
- Pressure: Brazilian made atmospheric pressure sensor.
- Temperature: thermistors and platinum RTDs used for sea and air temperatures.
- Humidity: Rotronic sensors for relative humidity.
- Radiation: Brazilian made incident and reflected solar radiation radiometer.
- Height of sensors: meteorological sensors located 2.7-3m above mean water line of buoy.

ANNEX II - 5

3. Data management

(a) *Data flow*

- Data are transmitted from the buoys via the CLS Argos system aboard NOAA Polar-orbiting Operational Environmental Satellites (POES) and routed to Service Argos in Toulouse.

(b) *Shoreside processing*

- Argos: data are accessed by INPE staff several times per week via telephone modem to support research studies and projects.

(c) *Quality control*

- Quality control for research purposes is done on a non-real-time basis

(d) *Dissemination*

- None in real-time

(e) *Buoy data are archived by INPE staff in Brazil*

CANADA

1. Introduction and historical overview

From 1952 to 1981 the Canadian Government operated two ships off the West Coast, primarily for meteorological observations but also for collecting a wide range of oceanographic data. These vessels sailed from Victoria to Ocean Station 'P' (PAPA) at 50N 145W. In June 1981 they were decommissioned and sold because of budgetary constraints. For several years the only direct source of marine meteorological data was from commercial vessels, drifting buoys, and US buoys moored in the Gulf of Alaska. Fishermen constantly lobbied for reinstatement of the weatherships and for other programs to improve the marine forecasts.

Environmental Canada can track major systems with little difficulty. However, occasionally rapidly deepening low pressure systems move in off the Pacific. These storms, often referred to as 'bombs' can be highly destructive if adequate warning is not provided. On the night of October 11, 1984, a 'bomb' struck the west coast of Vancouver Island sinking seven vessels and drowning five seamen. Soon after, an inquiry was launched to investigate the adequacy of marine weather forecasting on the West Coast.

This resulted in a cooperative effort between Environment Canada, Canadian Coast Guard, and Fisheries and Oceans Canada to take steps to improve marine sea state, weather forecasts, and search and rescue (SAR) response capabilities. One of the major steps taken was the establishment of a moored buoy network.

The Canadian program deployed its first 3-metre buoy in May, 1986, at Douglas Channel, south of Prince Rupert. This hull was originally designed by Woods Hole Oceanographic Institute and has since undergone many modifications by NDBC and Environment Canada. That year a contract was awarded to Seakem Oceanography Ltd (now called Axys Environmental Systems) of Sidney, British Columbia to build five Navy Oceanographic Meteorological Automated Devices (NOMADS). The aluminum hulls were designed after the NDBC (U.S.A.) models but the payloads are based on a ZENO designed by Coastal Climate Company of Seattle, Washington and built under license by Axys in Canada. Both the 3-metre and NOMAD use this payload. In June 1987, a second 3-metre discus buoy was deployed in Howe Sound near Vancouver. The first two Canadian NOMADS were deployed in September 1987 at the North NOMAD and South NOMAD location. Along with the expansion of the moored buoy network on the West Coast, similar efforts were underway on the Great Lakes and on the Atlantic Coast. Today, Environment Canada operates 33 buoy stations nationwide, in water depths ranging from 16 to 4500 metres. The Pacific network consists of 13 coastal 3-metre buoys and three offshore NOMAD buoys. An additional nine buoys, including two 12-metre discus buoys are operated on the Great Lakes and other major inland waters, while six NOMAD buoys and two 3-metre buoys are operated on the Atlantic Coast. The configuration of the Canadian network is shown in Figures II.1(a-c).

2. Moored buoys

(a) *Hull description*

- 3-m discus, weight 1540 kg, including payload and power system
- material: aluminum
- 6-m NOMAD, weight 5885 kg, including payload, power system, and ballast
- material: aluminum
- 12-m discus, weight 86,360 kg, including payload, power system and ballast
- material: steel

ANNEX II - 7

(b) *Moorings*

- Types: all chain and chain-link combination
- Design: taut and inverse catenary, depending on water depth
- Anchors: concrete and cast iron

(c) *Power systems*

- Primary power provided by air alkaline batteries that are supplemented by solar rechargeable secondary batteries

(d) *Electronics payload*

- Type: ZENO payload, developed for AES Canada. Watchman 100 payloads are being introduced into the system in 1996 and will replace the ZENOs.
- Kind of transmissions: hourly via GOES

(e) *Sensors*

- **Wind:** dual anemometers approximately 5-m above the water. Wind is averaged at 1 Hz for 10 min. Peak wind reported is highest 8-sec moving scaler average within the 10-min sample. The beginning time of the 10-min average is updated in the GOES message.
- **Pressure:** three types of barometers used: Air-DB-2A Intellisensor II, Air-DB-2A Intellisensor Air DB, and Paroscientific Sensor 1000 series digiquartz mounted in the ZENO housing and vented to the hull. Pressure readings are taken at 1 Hz for 10-sec before and 10-sec after the meteorological sampling period (i.e., 20 readings).
- **Waves:** two types of sensors: the Datawell Mk II heave sensor, and the single-axis Columbia Research or Schaevitz strapdown accelerometer (all 3-m buoys). Two hundred fifty-six heave samples taken at 1 Hz and subject to processing and filtering to produce 42 frequency range bands. Maximum wave is calculated as twice the maximum positive excursion of the wave above the mean level computed from the sample.
- **Air temperature:** Yellow Springs 44018 thermistor composite, with voltage output converted to frequency, according to temperature, and frequency output stored every 4-sec. The 4-sec values are averaged over the 10-min meteorological sample period to obtain temperature. Some concern concerning calibration coefficients and sensor drift.

(f) *Deployment procedures*

- Deployment, recovery and maintenance buoys is a joint effort involving Environment Canada, Fisheries and Oceans Canada, and Axys Environmental Systems. Each of these Departments supplies its own required expertise to the buoy program. And through the continued cooperation of the government departments, Environment Canada will sustain a high level of cost-effectiveness and reliability to the ODAS buoy program.







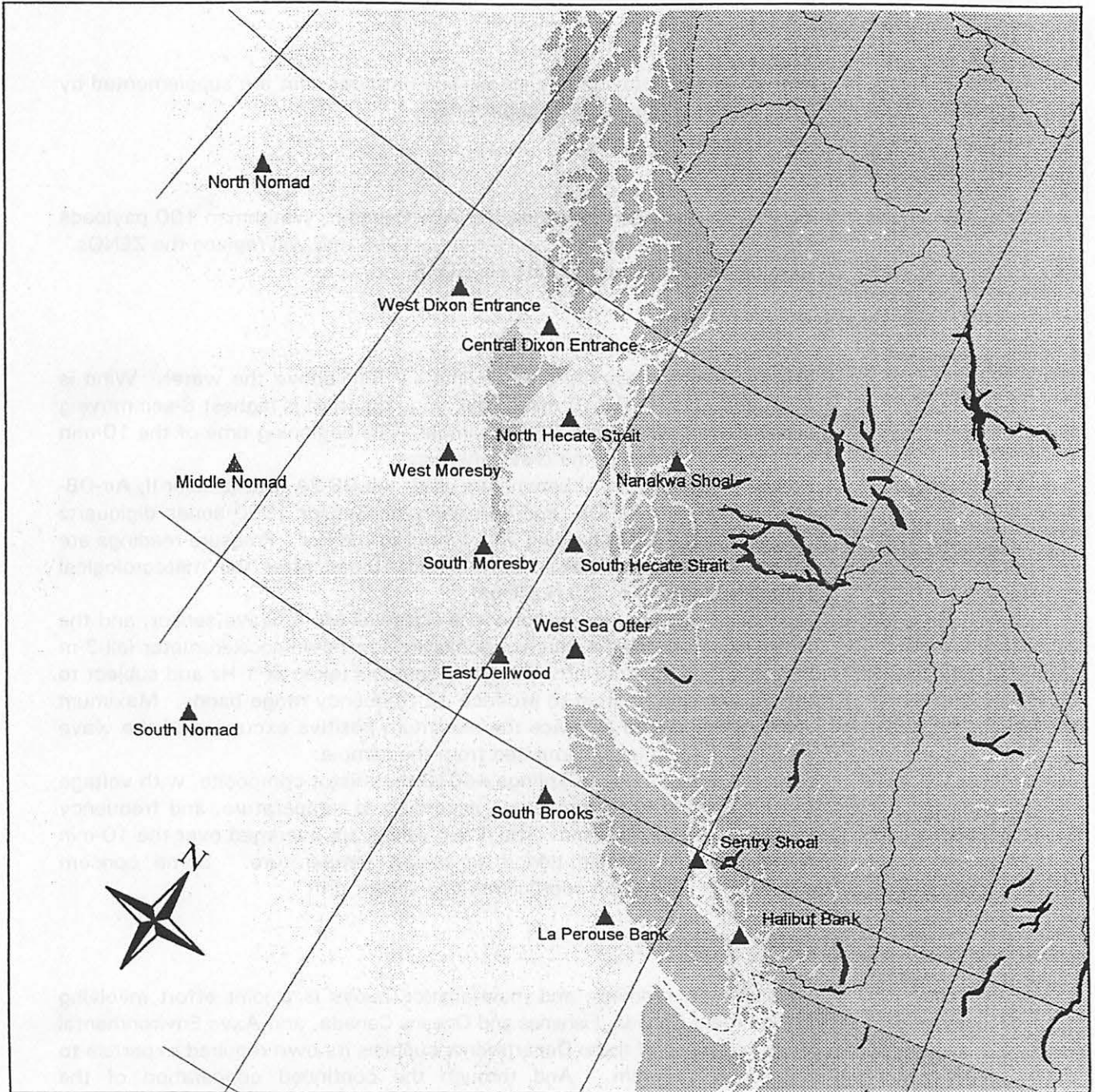

(g) *Special considerations*

- Position fixing hulls accomplished by Local User Terminal and GPS.

Figure II.1a

PACIFIC COAST CANADIAN ODAS BUOY LOCATIONS



-  Int./Prov. boundary
-  Lat/Long - 5 degrees
-  BUOY - Aug 16 /96
-  River
-  Lakes
-  CANADA
-  U.S.A.
-  Ocean

200 0 200 400 Kilometers



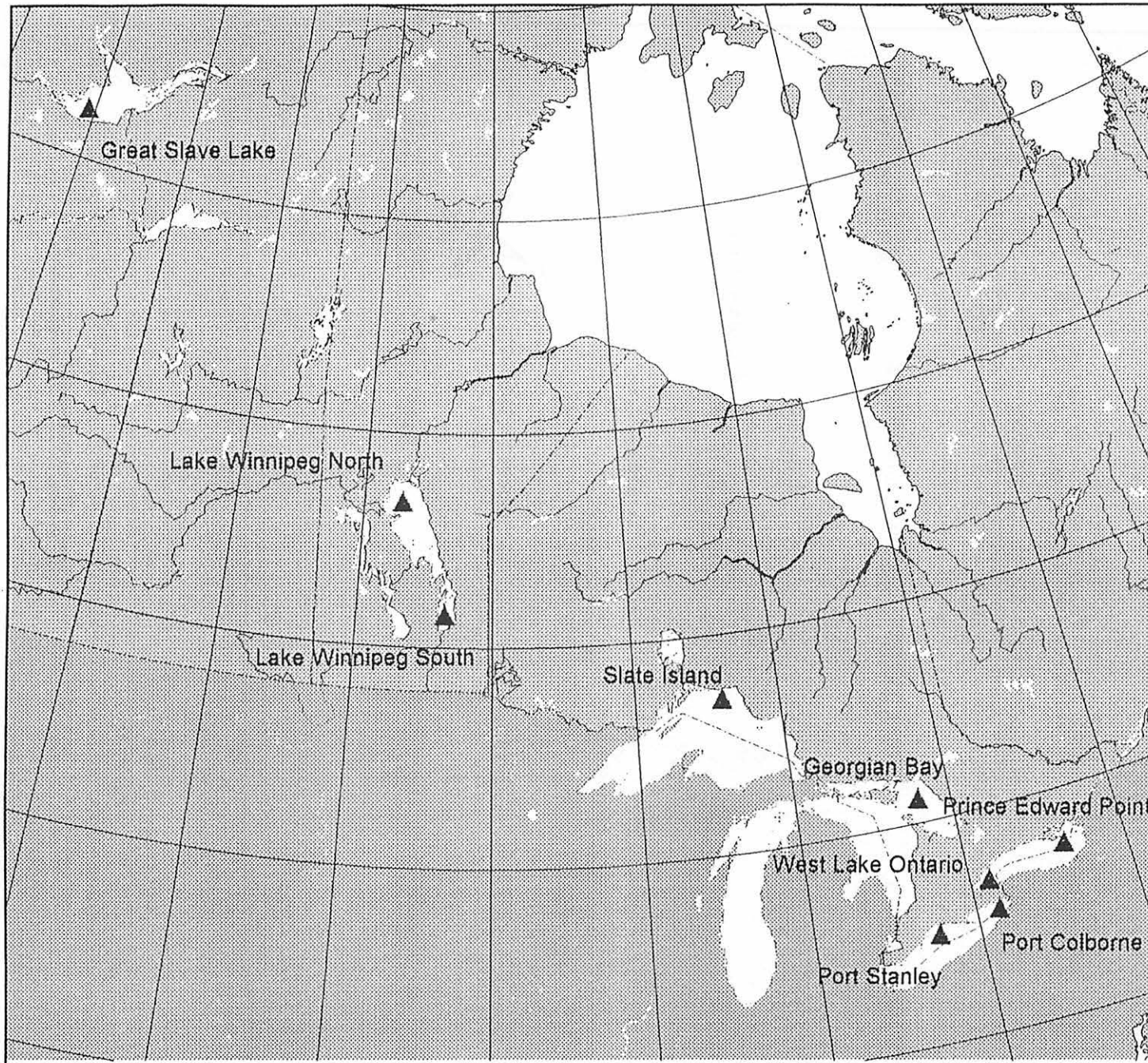

CANADIAN INLAND LAKES ODAS BUOY LOCATIONS

- Int./Prov. boundary
- Coast
- Lat/Long - 5 degrees
- BUOY - Aug 16 /96
- River
- lakes
- CANADA
- U.S.A.

Figure II.1b

500 0 500 1000 Kilometers

Figure II.1c

ATLANTIC COAST CANADIAN ODAS BUOY LOCATIONS

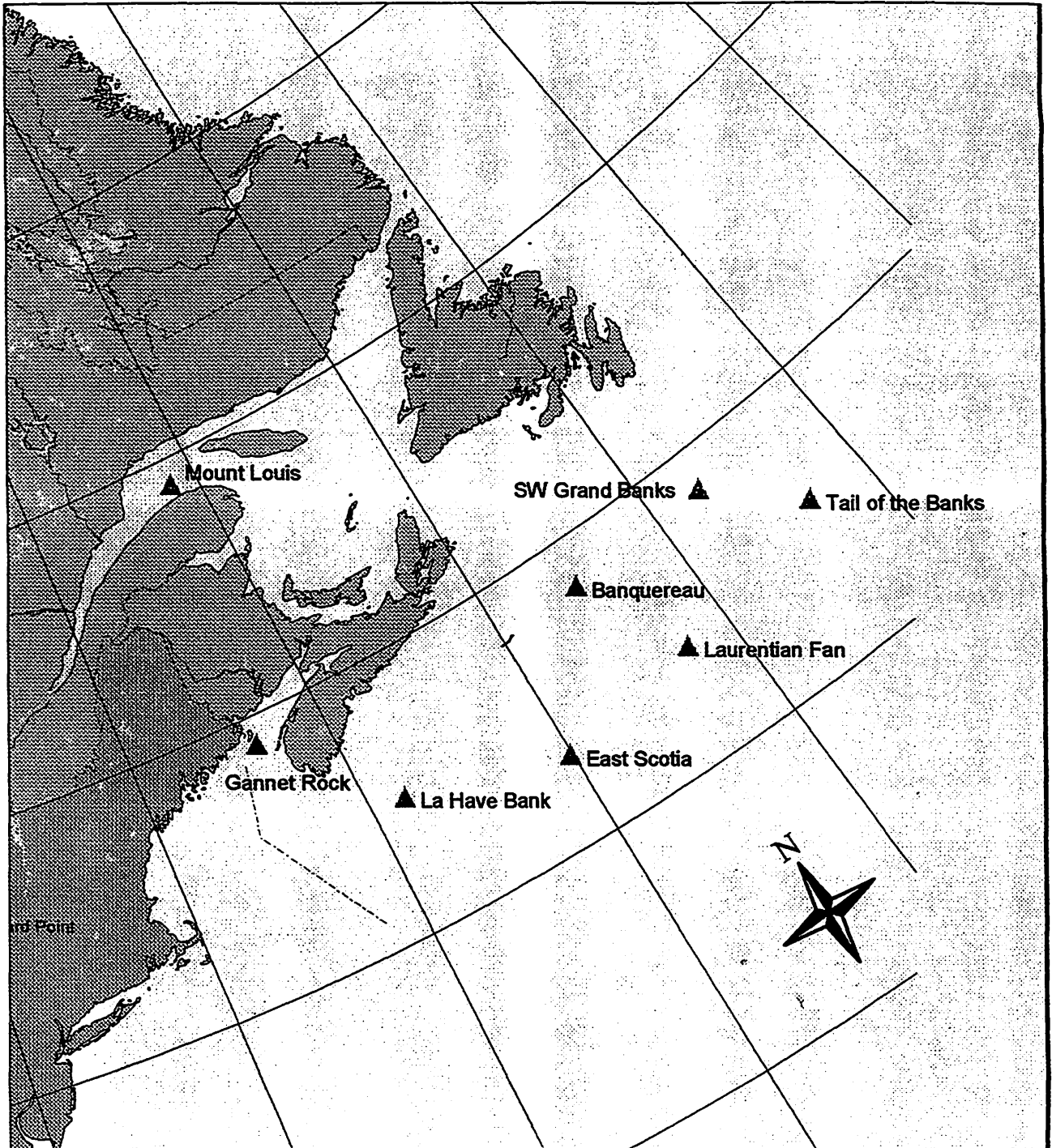

- Int./Prov. boundary
- Coast
- Lat/Long - 5 degrees
- BUOY - Aug 16 /96
- River
- Lakes
- CANADA
- U.S.A.
- Ocean

250 0 250 500 Kilometers



FRANCE

1. Introduction and historical overview

The Irish Meteorological Service, UK Meteorological Office and Météo-France, conducted the BOSCO programme, a joint project that lasted from 1985 to 1989. The buoy was a French prototype weighing 16 tons moored off southern Ireland in 600m of water. France supplied the hull and sensors, and was responsible for two deployments; the UK supplied the mooring and on-station buoy maintenance; Ireland provided some equipment.

Considering the UK's technical competence, Meteo-France decided to co-operate in order to maintain a buoy 300 km off Brittany in 2000m of water. This buoy is of a type developed by the UK and is supplied by the UK; France provides the mooring lines and services the buoy. It is anticipated the Brittany buoy will operate two years or more. Meteo-France plans to operate another buoy in the Bay of Biscay soon. A project of four more stations of that kind (two in the Mediterranean Sea, two in the West Indies) is also under study.

In addition, Meteo-France began operating two permanent directional wave measurement buoys in 1995 in support of the Oceanilles project. They are located in the West Indies. The French Aids-to-Navigation Service, STNMTE, which operates its own network of 10 wave buoys along the coast of France, assisted Meteo-France in the project.

2. Moored buoys

The Brittany buoy measures air pressure, temperature, humidity, wind speed and direction, sea surface temperature, wave height, and period. Most of the sensors have redundant equipment for measurements.

The Datawell waveriders provide directional wave spectra.

3. Data management

The data from the Brittany buoy are sent via Meteosat to Darmstadt, Germany, where data are directed to the UK Met Office. The UK Met Office makes the data available in FM 13-X SHIP code on the GTS.

The waverider data are recovered by HF radio link and through Service Argos. The HF radio link contains the full data set for climatological purposes; the Service Argos data set is reduced; however, the data are available in real-time and permits the buoy to be located if it goes adrift. The sea state information is transmitted via the GTS in FM 13-X SHIP code. The transmission of wave spectra in FM 65 WAVEOB code is under study.

GERMANY

1. Introduction and overview

A detailed network of storm warning stations for shipping was operated along the German coast in the 19th Century. The network provided a restricted set of observations and conveyed warnings to navigation. The services improved step by step during the last 100 years, but network was reduced considerably.

Routine measurements from light houses and light ships in Germany began in the early 1900s. They were taken along the coasts of the German Bight and Baltic Sea, thus creating a considerable time series of meteorological data at specific coastal locations. However, the responsibility for light ships and buoys in Germany fall under the authority of safety of navigation even though they serve as platforms for meteorological observations used by the German Weather Service. Thus, while the record of observations from lighthouses are often continuous, the record from light ships contains data gaps and varying positions.

The system today consists of automated systems on lighthouses and unmanned moored light ships.

2. Other ODAS

Today the Deutscher Wetterdienst operates automated systems on following platforms:

	Identifier (WMO)	Position
<i>Unmanned light vessels</i>		
UFS "TW Ems"	10004	54°10'N - 06°21'E
UFS "Elbe"	10005	54°00'N - 08°07'E
UFS "Deutsche Bucht"	10007	54°10'N - 07°27'E
<i>Light houses</i>		
LT "Kiel"	10044	54°30'N - 10°16'E
Position is NNE of the "Kieler Förde" and east of the "Eckernförder Bucht".		
LT "Alte Weser"	10124	53°52'N - 08°08'E
Position is nearly 46km NW of the city of Bremerhaven		

At present there are no plans for increasing the number of stations in the offshore area.

Exposure:

Data from the light houses show the following anomalies due to exposure:

Light house "Alte Weser": South wind is weaker under the influence of the littoral compared to the open sea.

Light house "Kiel": during northerly winds, the light tower building has an influence on the temperature.

Height of sensors:

Numbers refer to m above (- = below) sea surface (SL) or above mean sea level (NN)

ANNEX II - 13

Element	Lightships	Lighthouse "Alte Weser"	Lighthouse "LT Kiel"
Air pressure	0.0m SL	30.6m NN	32.5m NN
Air temperature	9.0m SL	34.0m NN	32.5m NN
Water temperature	-1.0m SL	-2.5m NN	-1.5m NN
Wind	13.5m SL	42.6m NN	35.5m NN
Visibility	8.5m SL	31.5m NN	23.0m NN
Sunshine-duration	13.0m SL	35.5m NN	33.0m NN

Special considerations:

Light ships and light towers are accessible by ship only. In situations of severe weather conditions or rough sea, especially in winter, unmanned light vessels cannot be entered, so that in case of equipment failures, greater data gaps have to be accepted. Situations like these may last for weeks.

Vandalism has not occurred up to now.

Instruments have to withstand severe weather conditions sometimes, as is characteristic for these latitudes.

Basic servicing interval on light ships is once a year, otherwise if required.

Electronics:

The automated systems are equipped with the following electronic components:

- light towers: sampling of measurements by a 12 bit microprocessor IM 6100 - PR 812; automated formatting by a 16 bit microprocessor 80 C 86 - PR 816
- light ships: 16 bit microprocessor 80 C 86 - PR 816 for both, automated formatting and sampling.

Sensors:

Wind speed: cup anemometer with opto-electric scanning; running 10-minute mean

Wind direction: wind vane with electric potentiometer reading; running 10-minute mean; on light ships the true wind direction is calculated by use of a wind vane and compass-values/magnetic compass: Digi Course System 100.

Air pressure: Pressure capsule with inductive scanning.

- on light ships - digital-barometer (AIR.DB.1AX)
- on light towers - air pressure-sensor (Hartmann & Braun)

Air and water temperature: platinum resistance thermometer PT 100; on light ships sensors in a globe (spherical) screen.

Humidity: hair hygrometer with potentiometer reading (Type "Lambrecht")

ANNEX II - 14

Visibility: back scatter measurement (Fumosens IV)

Sunshine duration: measurement of radiation intensity, minimum response 120 W/m²m (Type "Sony").

Operating characteristics: see Table II-1

Data management

Data flow and shoreside processing: Measurements are coded automatically by a microprocessor in FM 13 SHIP, routed by DCP via geostationary satellite (Meteosat) to an earth-station (EUMETSAT Darmstadt) and subsequently passed to the National Meteorological Centre, Deutscher Wetterdienst, in Offenbach, which puts the messages onto the GTS.

Quality control: Quick plausibility check before insertion into GTS. Near real-time quality check during the NWF analysis process. Non real-time high quality check for purposes of marine meteorological services.

Dissemination: Unrestricted, via GTS.

Archiving: Included in special marine Archives of the German Weather Service.

Operating Characteristics

Parameter	Unit	Range	Accuracy	Resolution	Time- constant	Scanning- frequency	Interval
Air pressure	hPa	800 - 1060	+/- 0.2	0.1	1 s	1 min	1 h
Air temperature	o C	-50 - +50	+/- 0.2	0.1	20 s	1 min	1 h
Water temperature	o C	-50 - +50	+/- 0.2	0.1	2 min	1 min	1 h
Wind speed	kt	0 - 120	+/- 0.5	0.1	-	1 s	1 h
Wind gusts	kt	0 - 120	+/- 0.5	0.1	-	1 s	1 h
Wind direction	deg.	0 - 360	+/- 5	1	-	1 s	1 h
Rel. Humidity	%	3 - 100	+/- 5	1	2 min	1 min	1 h
Visibility	km	0.1 - 10	+/- 20%	0.1	1 min	1 min	1 h
Sunshine duration	min	0 - 60	+/- 5%	2 s	-	1 s	1 h

Table II-1

ICELAND

1. Introduction and historical overview

Mariners in Iceland required real-time information on weather, water levels, and waves inside harbours, nearshore and offshore. Such information is vital to safety in vessel operation. The Icelandic Lighthouse and Harbour Authority (ILHA) has developed and implemented its Information System on Weather and Seastate for Seafarers, which is an automated call-up voice information system. It consists of 12 automatic weather stations in lighthouses, 6 Waverider buoys offshore, and 9 harbour installations that provide weather, wave, and tide information (Figure II-2 Iceland).

The first Waverider buoy was installed in 1969. Since then, measurements have been made periodically at 35 locations. Since 1995, 6 Waveriders have been in use.

2. Moored buoys

- (a) hull description - standard Waverider buoys;
- (b) moorings - depths from 32m to 130m deep.

3. Other ODAS

- kinds of stations - automatic weather stations on lighthouses. Information on best locations was developed by cooperation between the Icelandic Meteorological Office and experienced vessel operators.

4. Data management

- real-time information is available via an automated call-up voice information system.



ICELANDIC INFORMATION SYSTEM ON WEATHER AND SEA STATE FOR SEAFARERS

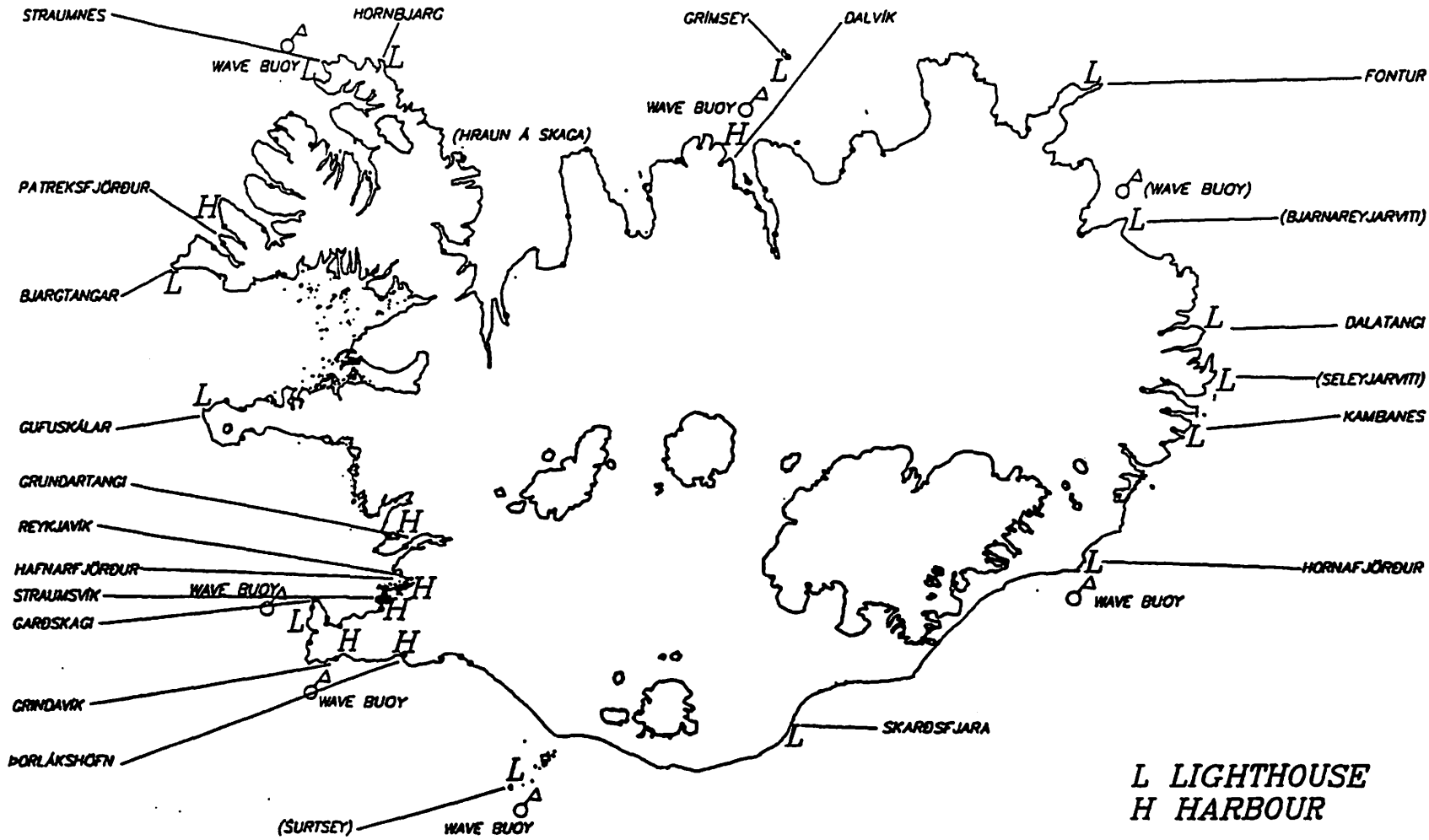

ANNEX II - 18

ISRAEL

1. Introduction and historical overview

The Israel Meteorological Service operates a small network of Waverider buoys in Haifa Bay, Ashdod, and Hadera Port. They measure sea state and sea surface temperature.

In addition, the Israeli Oceanographic Institute has launched a catamaran buoy in the Dead Sea off the coast of Ein-Gedi. Data from this system is transmitted directly to shore, quality-controlled in near real-time, and locally archived.

2. Moored buoys

(a) *Hull description:*

- Waverider: 0.9m diameter, 212 kg, AISI316 or 254SMO stainless steel
- Catamaran: 4.5 tons, steel, 3.5m high above sea surface

(b) *Moorings:*

- Waverider: rubber cords with chain ballast and 500 kg chain sinker, up to 30m depth (see Figure II-3)
- Catamaran: steel cable, 130m, anchored by chain weight, must be replaced every visit (every 4 to 8 weeks) due to salt sedimentation

(c) *Power systems:*

- Waverider: 85 no. 6 cells that operate 10 to 13 months, depending on buoy operational configuration
- Catamaran: solar

(d) *Electronics payload:*

- Waverider: accelerations in three planes are digitally integrated to displacement and filtered to a high frequency cut-off at 0.6 Hz. Every half hour, FFT transforms of 8 series of 256 data points are added to give 16 degrees of freedom on 1600 sec of data. Data compressed prior to transmission. Data transmitted directly ashore.

Transmitter:

output:	150 - 200 mW
frequency:	27 - 40 MHz
range:	max. 50 km
modulation:	± 80 Hz - FSK(0.2 F1)

- Catamaran: Data acquisition system, transmission ashore

(e) *Sensors*

- Waverider: Hippy 40 heave-pitch-roll sensor and sea temperature

Heave:

range:	-20 - + 20 m
resolution:	1 cm
scale accuracy:	3%
period time:	1.6 sec - 30 sec
zero offset:	< 0.5 m
cross sensitivity:	< 3%

ANNEX II - 19

Direction:

range:	0 - 360°
resolution:	1.5°
buoy heading error:	0.5 - 2° depending on latitude
period time ranges:	
- free floating condition:	1.6 sec - 30 sec
- moored condition:	1.6 sec - 20 sec

Sea surface temperature measurement:

range:	-5°C - +46°C
resolution:	0.05°C
accuracy:	0.2°C
longterm stability:	better than 0.1°C/year

- **Catamaran:** wind velocity, global radiation, air temperature, relative humidity, air pressure, water currents at 1 m, and water temperature at 11 depths to 40 m.

(f) *Deployment procedures:*

- **Waverider:** on-shore visits monthly; off-shore visits every 2 months; annual maintenance in the lab.
- **Catamaran:** permanent station serviced once every four to eight weeks, as necessary. Cleaning of dust and salt sedimentation is a special consideration.

3. Data management

- (a) **Data flow:** The data may be received in real-time via direct radio link, or a shortened message may be received via Service Argos. Signal transmitted directly to shore and viewed in real-time or logged. Data measured and transmitted hourly or once every 3 hours. Continuous measurements begin when sea height threshold is reached.
- (b) **Shoreside processing:** measurements received on shore and logged or displayed in real-time or near real-time.
- (c) **Data quality control:** real-time from Hadera Port waverider; quasi-real-time from Dead Sea catamaran.
- (d) **Dissemination:** data from Hadera Port waverider are transferred directly to Israeli Meteorological Service.

Figure II-3

Moorline layout for
"Directional Waverider"

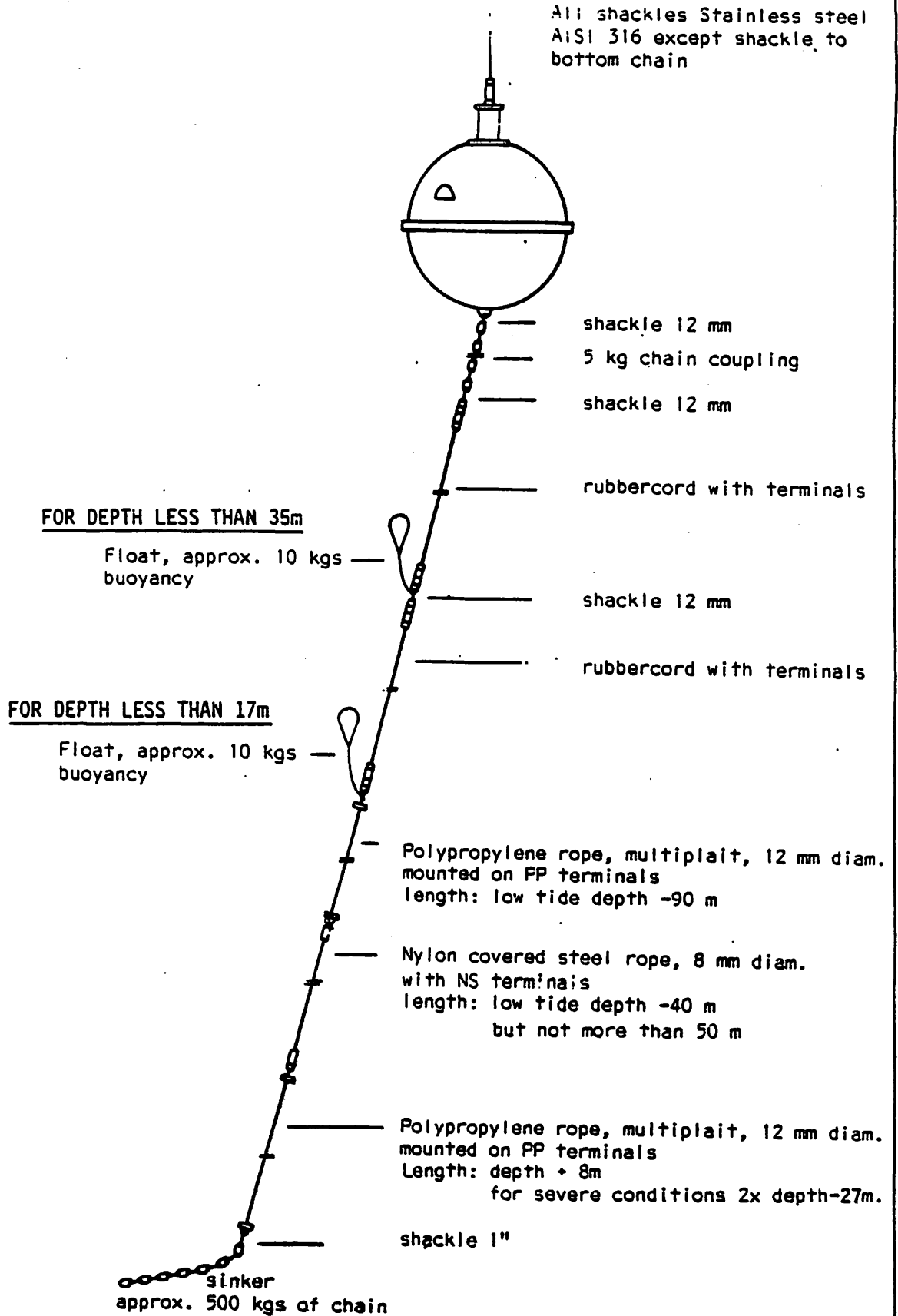

JAPAN

1. Introduction and historical overview

Since Japan is surrounded by the ocean, real-time collection of maritime meteorological and oceanographic data is necessary for timely issuance of weather warnings.

Japan's ocean data buoy program was initiated in 1968 and evolved through the following three phases: 1) the pilot buoy system; 2) an operational buoy system with HF radio link; and 3) an operational buoy system with satellite data link.

The first two pilot moored buoys were discus-type, 3.5m in diameter and weighing 3 tons. Their test deployments were carried out in the Japan Sea from 1969 to 1972. The first operational buoy system was fabricated in 1972 and deployed about 770km southwest of Tokyo in 4160m depth. After it operated successfully for 9 months, the Japan Meteorological Agency (JMA) started regular deployments of moored ocean data buoys in the seas around Japan. The buoys measure wind direction and speed; barometric pressure; air temperature; wet-bulb point temperature; solar radiation; wave height and period; and water temperature at 3 depths.

At 10m in diameter, these operational buoys are much larger than those in the pilot buoy system, designed to operate unattended up to 25 months, and survive winds up to 60 m/s, significant wave heights up to 15m, and currents up to 285 cm/s.

Another experimental ocean data buoy, almost identical in shape to the operational buoys, was operated east of Tokyo from October 1983 to June 1984 to obtain the characteristics of wind waves in addition to the standard meteorological and oceanic parameters.

The JMA has constructed a total of seven operational buoy hulls; of the seven, four buoys remain in operational service, deployed in turns at three ocean stations (Figure II-4 and Table II-2 Japan).

Observations are provided usually every three hours; however, all buoys were equipped recently to report every hour when wind speeds are measured above 16.7 m/s.

Buoy observations were transmitted via HF radio to the JMA Meteorological Satellite Center signal receiving station near Tokyo until 1978. Since 1978, all of the buoys have updated via the JMA Geostationary Meteorological Satellite (GMS).

2. Moored buoy system

(a) *Hull*

Shape:	thick-discus
Size:	10m in diameter and 1.9m in depth
Weight:	50 tons (including 12 tons of water as ballast)
Buoyancy:	90 tons
Material:	steel of 10mm thickness

(b) *Mooring*

Design:	semi-taut (The scope is selected as 1.1)
Anchors:	1) 2-tons stockless AC-14 anchor (for shallow mooring) 2) 500kg Danforth anchor (for deep mooring)

ANNEX II - 22

(c) *Power*

Primary: air-depolarized batteries
(Each unit has a capacity of 2,000 AH)
Secondary: alkaline batteries

(d) *Electronics*

The electronics components of the buoy consists of the following four systems: a data acquisition and control system (DACS), a power system, sensor system, and a transmission system.

The DACS is comprised of crystal clock, analog-multiplexers, A/D converter, coding and memory units. As for the capacity of the memory, the DACS has 64K bits for control program and 16K bits for data storing.

The microprocessor for system control and data processing is of Z80 type. The transmission system comprises PSK (Phase Shift Keying) modulators, exciter, amplifiers and an antenna of Archimedes spiral type. The system for measuring wind direction/speed and pressure is doubled.

Data transmission is carried out through the GMS. Specifications for transmitting are as follows:

Carrier frequencies: 402.1046 MHz or 402.1286 MHz
Class of emission: G1D
Effective radiation power: 20 W
Modulation type: PCM-PSK (pulse code modulation-phase shift keying)
Signal form: NRZ-L
Signal speed: 100 bps

A message is sent twice at an interval of 1-minute. It takes 17 seconds to make each transmission.

Observation and data transmission are usually carried out every three hours, while each buoy has a capability to make hourly observations/transmissions under severe weather when wind speeds exceeds 16.7 m/s.

(e) *Sensors*

Eleven meteorological and oceanographic elements, namely wind direction and speed, barometric pressure, air temperature, wet-bulb temperature, solar radiation, wave height and period, water temperature at 1, 50, 100 meters, are measured. Sensors for wind direction, wind speed, air temperature, wet-bulb point temperature and global solar radiation are located on the platform atop the mast. Sensors for barometric pressure and wave height/period are installed within the hull. Characteristics of the measurement are as follows:

Position of the buoy is determined using GPS (Global Positioning System) for house keeping. Furthermore, three engineering sensors are installed to monitor the buoy status. Alarm signals of battery voltage, hatch open, and flooding are transmitted.

Wind direction - Wind vanes are used to measure wind direction relative to the buoy. A magnetic compass is mounted on the aluminum arm on the mast to find true north. Outputs of the wind vane and the compass make true wind direction.

ANNEX II - 23

range of measurement:	0-360°
resolution of measurement:	10°
accuracy of measurement:	± 10-36°
height of sensor:	7.5m above the sea surface

Wind speed - Three cup anemometer is used.

range of measurement:	0-120 kt
resolution of measurement:	0.1 kt
height of sensor:	7.5m above the sea surface

Barometric pressure - A variable capacitance sensor is used as a barometer. The sensor is installed in the battery room, where ventilation pipes are open to free air at the upper part of the mast.

range of measurement:	920-1040 hPa
resolution of measurement:	0.1 hPa
height of sensor:	close to the sea surface

Air temperature and wet-bulb temperature - A ventilated psychrometer with platinum thermometer probes is used, and water drops are fed to the wet bulb at the beginning of each measurement.

range of measurement:	-10-40°C
resolution of measurement:	0.1°C
height of sensor:	7.5m above the sea surface

Global solar radiation - CdS (Cadmium Sulfide) or solar cell is used as sensing element of global radiation. Inclination error due to the hull is not compensated, because the measurement of global radiation is aimed to help identification of weather types.

range of measurement:	0-1.4kw/m ²
resolution of measurement:	0.1kw/m ²
height of sensor:	7.5m above the sea surface

Wave height and period - Output voltage of accelerometer is integrated by a double integrator, and acceleration is transformed into relative displacement of the buoy hull. An average of displacement in 400 seconds is taken as wave height, and 20 successive waves are counted to determine wave period.

(wave height)

range of measurement:	0-20 m
resolution of measurements:	0.1m
height of sensor:	close to the sea surface

(wave period)

range of measurement:	0-20 sec
resolution of measurement	0.1 sec
height of sensor:	close to the sea surface

ANNEX II - 24

Water temperature - Platinum thermometer probes are used.

range of measurement:	-10-40°C
resolution of measurement:	0.1°C
height of sensor:	beneath the hull at 1m depth, and on the mooring cable at 50m and 100m depths

(f) *Deployment*

The transport, anchoring, recovery of buoys are conducted by a marine contractor under the supervision of the JMA.

Preparation: Pre-deployment tests are carried out for measuring and transmitting system in a port.

Type of ship: A tugboat of about 500 tons is used.

Mooring deployment: The procedure depends on the depth of the site. (For deep mooring) The anchor is released to sink freely after paying out the entire mooring rope. (For shallow mooring namely the depth less than 200 meters). The anchor is lowered onto the sea floor by a crane on the boat

Recovery of the mooring: By pulling up the whole mooring system including the anchor

Ground truth data: Data obtained by research vessels of the JMA on their service visits.

Service visits: Research vessels of JMA visit each of the buoys once a year, and simple repairs of units with trouble are carried out at the deployment sites.

(g) *Special considerations / Mooring failures and capsizing of buoy*

Mooring failures occurred several times during the 20-year operation. As one of their causes, it is presumed that the mooring cable may have been caught in fishing nets and/or became fatigued by severe weather, such as a typhoon.

Although buoys are designed to survive in rather severe weather, a buoy at the station in the East China Sea was actually capsized after a break of mooring rope due to a typhoon on August 26, 1986, when the wind speed was 56.9m/s, the significant wave height was 17.8 meters, and air pressure was 969.3 hPa.

(h) *Refurbishment*

Each buoy is overhauled at intervals of one or two years. Cleaning and repainting of the hull, changeout of batteries, adjusting of sensors, and overhaul of transmitter are carried out at a port near Tokyo, according to the specifications laid down by the JMA.

3. Data management

- (a) **Data flow:** Raw data from JMA buoys are transmitted to the Meteorological Satellite Center (MSC) of the JMA via the GMS. The data are encoded at the MCS in accordance with three formats, i.e., two WMO code formats (FM-13 Ext. SHIP and FM-63 BATHY), and a domestic format which includes whole observational elements. These encoded data are sent by exclusive landline to the JMA HQ. From there, SHIP and BATHY reports are put onto the GTS for international exchange, and disseminated to overseas meteorological offices through the GTS and disseminated to domestic relevant organs through dedicated lines. Data sent in the domestic code format are archived after quality checks.
- (b) **Processing:** An original data message is sent from each buoy twice at each transmission. The two messages are checked and the more reasonable one is adopted if they differ. Then the selected message is decoded and converted to a SHIP, a BATHY, and a domestic format after scale conversions and calculation of dew-point temperature.

(c). **Quality control**

Real time reporting SHIP and BATHY reports are automatically made at the MSC and inserted onto the GTS without any quality control at the JMA. Data quality is monitored during the analysis of weather charts including plotted buoy report at the JMA HQ. Once an error and its cause have been identified at the JMA HQ, the MSC is directed to take appropriate measures, such as eliminating or adjusting the erroneous element prior to coding into SHIP/BATHY reports.

Non-real time quality control Range checks and time-continuity checks are applied to all the data before they are archived. Erroneous data are deleted or corrected.

- (d) **Archiving:** Processed and edited data are annually published in the form of CD-ROM in the title of "Data Report of Oceanographic Observations." They are also archived in the JMA HQ.

Figure II-4 - Locations of the operational ocean data buoys

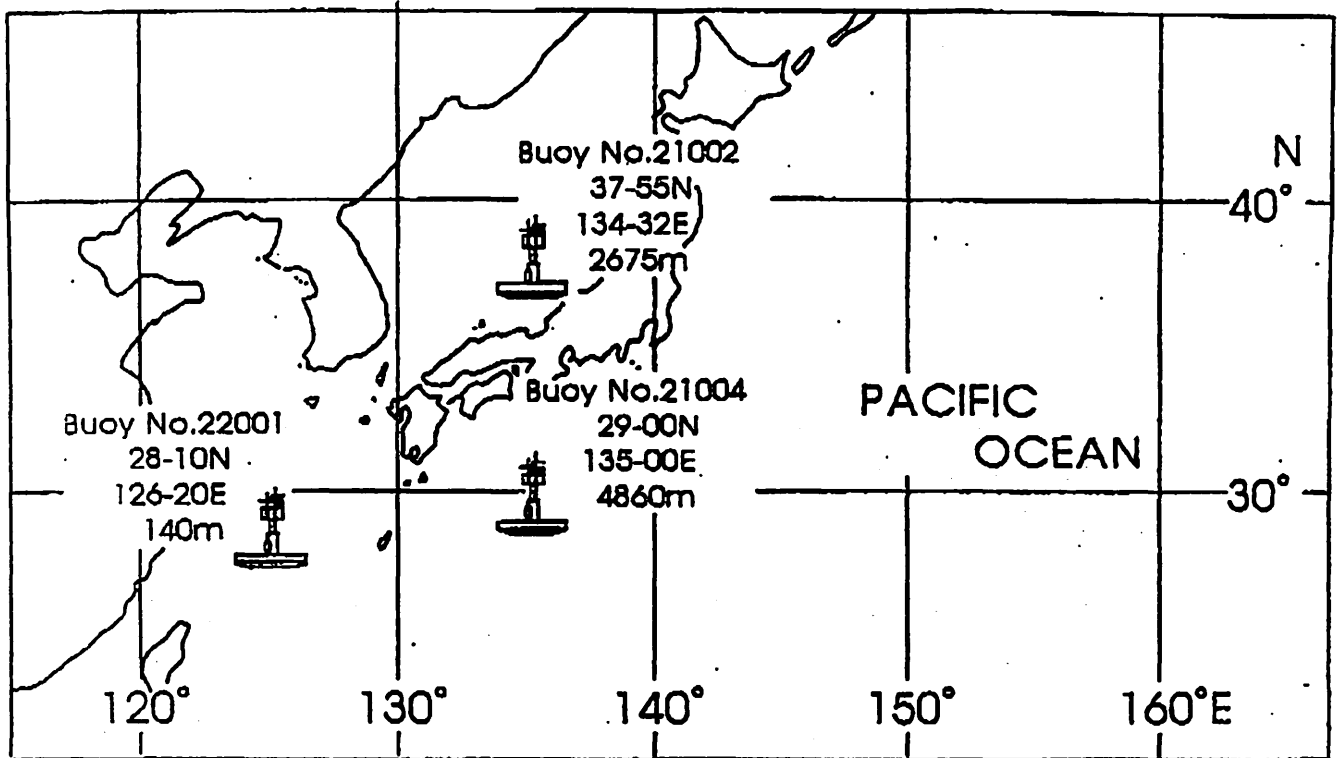

Table II-2 - Operation of buoys

station *	latitude	longitude	water depth	operation period **	
-	37-00 N	147-00 E	5555 m	Jul. 1975	~ Dec. 1975
-	39-30	145-30	5300	Jul. 1978	~ Feb. 1981
21001	38-30	145-30	5300	Sep. 1982	~ Nov. 1986
21001	36-40	145-40	5480	Apr. 1987	~ May 1991
21002	37-45	134-23	2590	Nov. 1976	~ Oct. 1987
21002	37-55	134-32	2675	Oct. 1987	~
21003	25-40	135-55	3470	Nov. 1974	~ Oct. 1986
21003	34-42	139-27	21	Dec. 1986	~ Jul. 1987
-	29-59	135-30	4160	Aug. 1973	~ May 1974
21004	29-00	135-00	4860	Jun. 1982	~
21010	32-00	147-00	6000	Oct. 1983	~ Jun. 1984
22001	28-20	126-05	115	Sep. 1974	~ Sep. 1983
22001	28-10	126-20	140	Apr. 1984	~

* WMO ODAS LD. Number

** Including interruption for overhaul

THE NETHERLANDS

1. Introduction and historical overview

In the North Sea, a coherent group of seven oil rigs and other platforms is equipped with hydrological and meteorological instruments. The need for such ODAS is based on several groups of users. Among them the main user groups are concerned with shipping, off-shore activities, hydrology (bottom topography, shipping corridors), coastal management (storm surge information), heli-operational guidance, general meteorological forecasting, reference data acquisition for hydrological models (wave, tide), and biological measurements. The network is within the Ministry for Traffic, Public Works and Water Management, which is a cooperative activity between the North Sea Directorate, the Royal Netherlands Meteorological Institute (KNMI) and the Directorate for Coastal Zone Management.

As the early predecessor of the present network on the North Sea, the wave observations were automated in 1975. The real network started in 1982 after a period of development and installation on four platforms. The central facility for data acquisition, processing, and distribution was situated in Hook of Holland. Users could get direct operational access via telephone lines to the 10-minute observations database for hydrological and meteorological information. Since then, the network grew to the present seven stations.

The data input, data transmission, and the data distribution has been upgraded eventually to modern standards. The North Sea Network is interconnected to all other hydrological networks in The Netherlands (with a total of 200 measuring sites).

New developments will cover the automation of visual observations (WaWa) and the introduction of chemical and biological sensors.

2. Moored buoys

None.

3. Other ODAS

(a) *Kinds of stations*

Offshore (rigs and platforms) The system is based on the principle of the Automatic Weather Station, extended with manual input capabilities. Two coastal stations are included as part of the total network.

(b) *Exposure*

Every location has been optimized but is affected by unavoidable obstructions (towers, masts, etc.). The height of the sensors is, depending on the constructional limits, in agreement with the WMO recommendations. For air pressure, wind speed, and wind direction, a correction for the height is made while processing the data.

(c) *Special considerations*

The locations have been selected on the basis of spatial diversification. The access to the platforms is guaranteed through an agreement between the North Sea Directorate (as managing organization) and the platform owner. No special

precautions towards vandalism have been taken. There is no climate-related relevance from the North Sea Network, only operational importance.

(d) *Electronics*

- The sensor interface has been designed by KNMI and takes care of the electronical adaption between the sensor and the data acquisition module. This Sensor Intelligent Adaption Module provides the processing module with a standard input so that the processing algorithms can be simplified.
- Transmission of the data from the platforms is performed by telemetry (dedicated lines), except for location F3B, using the METEOSAT DCS.

(e) *Sensors*

Temperature	PT500
Humidity	HMP233 (Vaisala)
Wind direction	KNMI-developed weather-vane (8-bit Grey Coded)
Wind Speed	KNMI-developed Anemometer (Pulse-Freq.)
Visibility	IR Forward-scatterometer(HSS-PW205B)
Air Pressure	Paroscientific

All instruments are within the WMO specifications. For the distribution of the data 10-minute averaged values are made available.

4. **Data management**

(a) *Data flow*

Centralized data acquisition and data distribution (except for location F3B).

(b) *Shoreside processing*

- Centralized data processing, 10-minute averaged data values, data presentation in graphical format by a multi-functional package on workstations at user side; hourly bulletins in SHIP code via De Bilt into GTS.
- F3B data in WMO format on GTS through the Darmstadt (Germany) receiving station.

(c) *Quality control*

Operational validation by the Maritime Meteorological Department as basis for quality assurance.

(d) *Dissemination*

National (several users) and international (GTS)

(e) *Archiving*

Observations Database at KNMI (De Bilt, the Netherlands)

UNITED KINGDOM

The United Kingdom moored buoy programme is described in Figures II-5a through II-5c and Tables II-3 through II-5 on the following seven pages.

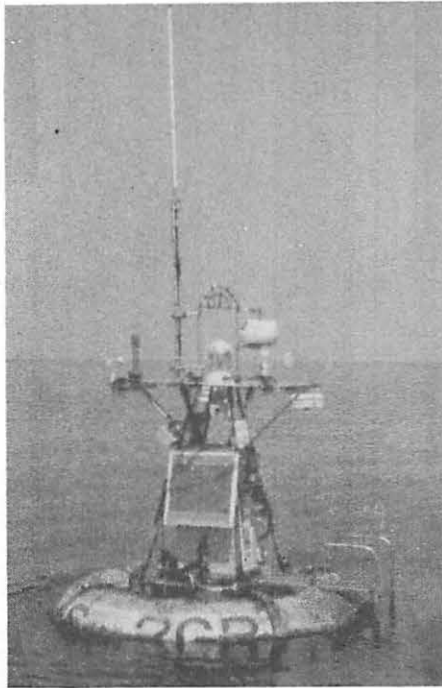

Fig. II-5a - UKMO inshore buoy



Fig. II-5b - UKMO light vessel automatic weather station



Fig. II-5c - UKMO open ocean buoy

TYPE OF ODAS	ITEM	DETAILS / COMMENTS
Moored Open-Ocean Data Buoy		Designed for mooring in any depth of water between 30 and 6,000 metres
	Hull	<p>Shape: Cylindrical - semi spar 2.8 metres diameter 3 metres from base to deck.</p> <p>Material: steel framework with integral cylindrical equipment well, circular foot and four equally spaced mast mounting points at deck level.</p> <p>Closed cell foam buoyancy collar, protected by high abrasion resistant yellow elastomer</p>
	Mast	<p>Marine quality stainless steel space frame with 4 legs, integral lifting structure and 1.5 metre diameter, sensor mounting, ring.</p> <p>The structure bolts on to the 4 deck level mounting pads</p>
	Mooring	<p>Shallow water mooring (less than 50 metres): all chain with, riser, ground chain and steel clump.</p> <p>Deep water mooring (50 to 6,000 metres): inverse catenary comprising, 50 metres of chain pendant, 1135 metres of nylon spliced to 138 metres of polyoleofin, a 1 tonne reserve buoyancy sub-surface float, attached to a lower polyoleofin rope, whose length is determined by the required mooring depth. At the sea bed is a steel clump, 50 metres of ground chain, chain riser and an acotic release</p>
	Power system	Sealed lead acid gel batteries charged by solar panels
	Electronics payload	Hourly synoptic observations from microprocessor based data acquisition systems each feeding duplicated DCP Meteosat/GOES transmitters. Two GPS receivers confirm the buoy's location, There is also a single independent ARGOS transmitter, mounted at deck level.
	Sensors	<p>Duplicated sensors for:</p> <p>Barometric pressure (instantaneo reading),</p> <p>wind speed (10 minutes average)</p> <p>maximum gt (three seconds maximum since the last observation),</p> <p>wind direction (10 minutes average),</p> <p>air temperature (instantaneo reading)</p> <p>relative humidity (instantaneo reading).</p> <p>All these sensors are exposed on the mast structure, at approx 4 metres above nominal sea level.</p> <p>Sea temperature (instantaneo reading, sensors exposed at 1 metre depth).</p> <p>Significant wave height and period (averaged over 17.5 minutes, single sensor).</p> <p>Other details are on attached sheet</p>
	Deployment procedures	<p>Preparation is a 1 week soak test of the fully equipped buoy on the dockside at the port of embarkation.</p> <p>The type of ship normally ed is 2,000 tonne, ocean going, salvage and mooring vessel, equipped with a 10 tonne, minimum SWL over the side, capacity crane. The buoys are ually carried on the deck although they may be towed at up to seven knots. 4 specialist buoy servicing personnel pl the ship's crew are required for each visit.</p> <p>Deployment sequence: Mooring followed by the buoy and the deployment of external sensors, Recovery is in the reverse order.</p> <p>Ground truth: hourly check observations between 06 and 21Z before, during and after deployment/recovery, to verify the accuracy of the sensor data.</p> <p>Hazards: Work at sea is always hazardo but with experienced deck crew and a well planned procedure the risks during deployment and recovery of data buoys are minimised.</p> <p>Servicing visits: Are nominally every six months to exchange external sensors., biennially for buoy exchange and triennially for mooring exchange.</p>

Table II-3 - Guide to UK Met Office moored buoys and other ODAS

TYPE OF ODAS	ITEM	DETAILS / COMMENTS
	Special considerations	Data losses have occurred at different times as a result of electronics faults, sensor failure, severed moorings and vandalism. Data loss has also occurred within the buoy/satellite/ground station link but overall there have been no systematic caes for data loss. Generally 90% or better, data availability, is achieved.
	Refurbishment	Refurbishment generally, consists of high pressure water cleaning and repainting of identification marks and steel base, followed by replacement of the sacrificial anodes and mooring eye, as necessary
Moored Inshore Data Buoys		Designed for mooring in depths of water up to 50 metres
	Hull	Shape: Toroidal 2.8 metres diameter Material: A yellow GRP toroid filled with closed cell material supporting stainless steel space frame.
	Mast and Supporting Framework	Marine quality stainless steel space frame with 4 legs, integral lifting structure and 1.5 metres diameter, sensor mounting ring, height 2 metres above the toroid. The toroid is bolted into the structure.
	Weight	The total weight of the buoy is 1 tonne with an operational reserve buoyancy of 1 tonne
	Moorings	Mooring: (≤ 50 metres) all chain with riser, ground chain and steel chump
	Power System	Sealed lead acid gel batteries charged by solar panels
	Electronics Payload	A single microprocessor based data acquisition system, feeding a UHF transmitter/receiver. A GPS receiver, to confirm buoy location. The buoy transmits hourly synoptic data to a shore station but it is also possible to obtain asynoptic data by interrogation.
	Sensors	The single set of sensors for: barometric pressure (instantaneo reading), wind speed (10 minute average), maximum gt (3 second maximum since the last observation) wind direction (10 minute average) air temperature (instantaneo reading) relative humidity (instantaneo reading), (All are exposed on the mast structure, at approximately 2 metres above nominal sea level.) Sea temperature (instantaneo reading, sensor exposed at 1 metre depth). Significant wave height and period (averaged over 17.5 minutes, single sensor). Other details are on attached sheet.
	Deployment Procedures	Preparation is a 1 week soak test of the fully equipped buoy on the dock side at the port of embarkation. The type of ship normally ed is a 2,000 tonne, ocean going, salvage and mooring vessel, equipped with a 10 tonne, minimum SWL, over the side, capacity crane, although a lower capability vessel could be suitable. The buoys are carried on the deck to the deployment site. Three specialist servicing personnel pl the ship's crew go on each deployment/recovery visit. The mooring is deployed first and then the buoy. With recovery the buoy is recovered and the mooring follows. Hourly check observations between 06Z and 21Z before during and after deployment/recovery, to verify the accuracy of the sensor data. Work at sea is always hazardo but with experienced deck crew and a well planned procedure the risks during deployment and recovery of this type of data buoy is minimal. Servicing visits are nominally six months for external sensor changes and annually for buoy and mooring change.

TYPE OF ODAS	ITEM	DETAILS / COMMENTS
	Special Considerations	Data losses have occurred at different times as a result of electronics faults, sensor failure, failures in the mooring material and vandalism. Data loss has also occurred within the line of sight buoy to shore station link. There have been no systematic cases for data loss. Experience has shown that the quantity and quality of data from the inshore buoys are very good. Data returns of better than 90% of potential observations are expected.
	Refurbishment	As the stainless steel structure is rarely damaged, the only refurbishment is high pressure water cleaning, to remove marine growth and the repainting of the identification marks on the toroidal hull.
Light Vessel Automatic Weather Station		Operated by Trinity Hoe of the UK, the light vessels are navigation and hazard warning aids moored in the centre of traffic separation schemes and in the vicinity of sand banks etc.
	Hull and Superstructure	Ship shaped, painted red, 24 metres long, 7 metres wide, the deck is 2 metres above nominal sea level, the top of the light tower is 6 metres above deck level
	Power System	Power - 240 volt, 50 hz from the light vessel's supply.
	Electronics Payload	Hourly synoptic observations from dual UK Meteorological Office designed data acquisition systems each feeding duplicated DCP Meteosat/GOES transmitters.
	Sensors	<p>Duplicated sensors for:</p> <ul style="list-style-type: none"> Barometric pressure (instantaneous reading) Wind Speed (10 minutes average) Maximum Gt (three seconds maximum since the last observation) Wind Direction (10 minutes average) Air Temperature (instantaneous reading) Relative Humidity (instantaneous reading) <p>(All are exposed on the top of the light tower, at approx 8 metres above nominal sea level)</p> <ul style="list-style-type: none"> Sea Temperature (instantaneous reading, sensors exposed, down the side of the Boarding ladder, at 1 metre below nominal sea level) Visibility (instantaneous reading, sensor exposed at 3 metres above deck level) Significant wave height and period (averaged over 17.5 minutes, single sensor) <p>Other details are on attached sheet.</p>
	Deployment Procedures	Preparation is a 2 week soak test of the fully operational light vessel automatic weather station, at a Trinity Hoe base, before the light vessel is towed onto station. Servicing visits are nominally every six months to exchange external sensors, and triennially for light vessel exchange.
	Special Considerations	Data losses have occurred at different times as a result of electronics faults, sensor failure and the loss of light vessel power. Data loss has also occurred within the buoy/satellite/ground station link. Generally 95% or better data availability has been achieved.
	Refurbishment	The meteorological equipment is removed when a light vessel is taken off station for dry docking and re-installed on a vessel destined for an appropriate station.

METEOROLOGICAL & OCEANOGRAPHICAL VARIABLE	TYPE OF SENSOR OR ASSOCIATED EQUIPMENT	MANUFACTURER'S TYPE & NUMBER	RANGE	CALIBRATION ACCURACY	FIELD ACCURACY FROM TRIALS* EXPECTED#	COMMENTS
1. ATMOSPHERIC PRESSURE	Aneroid or vibrating cylinder barometer	Rosemount Type 1201F1B or Solartron Type 788/1T	900 - 1050 mb	± 0.1 mb	± 0.2 mb #	
	Non-rotating static pressure head					Designed by the Meteorological Office. The device has no moving parts and removes the dynamic pressure effects of the wind.
2. AIR TEMPERATURE (DRY BULB)	Platinum resistance thermometer Mk 4A	Rosemount Type E13418	- 30° to + 40° C	± 0.1°C	± 0.2°C *	Thermometer to BS.1904 with $R_0 = 100\Omega$ $\alpha = .00385$
3. HUMIDITY	Electrical hygrometric circuit element	Phys - Chemical Research Corps type PCRC11	35 - 100%RH	± 2% RH	± 5% RH *	Requires protection from halides and sulphur contamination. A hoing with a filter has been designed to cope with this problem. <i>Note:</i> The resistance thermometers and humidity sensors are hoed in a Met Office designed screen consisting of a series of inverted discs.
4. WIND SPEED AND MAXIMUM GT	Cup anemometer	Vector instruments model A100R4	0 - 150 kt	± 1 kt *	± 1 kt *	Specially modified for e in a marine environment and filled with a light oil
5. WIND DIRECTION	Wind vane	Vector Instruments self-referencing SRWI-G	1- 360°	± 5°	± 5°	Fitted with a shroud to prevent salt spray from penetrating the moving parts. the self-referencing wind vanes are ed on all moving platforms.
6. SEA TEMPERATURE	Platinum resistance thermometer element	Meteorological Office design ing Rosemount element type E712A	- 30°C to + 40°C	± 0.1°C	± .0.2°C #	Two design are in e, one is an external rod, the other is 'in-hull' limpet version
7. WAVE HEIGHT & PERIOD	Wave Sensor	Datawell Mk 2	Wave height ± 10m (Crest to Trough) wave period 5-20 secs	+ 2%	± 5% #	

Table II-4

IDENTIFIER		LOCATION	VARIABLES MEASURED										COMMENTS			
WMO	OTHER	POSITION	DATE Deployed	Air Temp	Air Press	Press Tend	Humidity	Dew Point (Derived)	Wind (DD,FF)	Max Gust	Waves (SigHt, Period)	SST	Visibility	Code	Status	
62101	Lyme Bay	50°37N 02°44W	1981	24	24	24	24	24	24	24	24	24		FM113	Operational	2.5m toroidal hull
62302	Eskmeals	54°08N 03°37W	May 1991	24	24	24	24	24	24	24	24	24		FM13	Operational	2.5m toroidal hull
62301	Aberporth	52°17N 04°30W	April 1991	24	24	24	24	24	24	24	24	24		FM13	Operational	2.5m toroidal hull
62163	ODAS Brittany	47°32N 08°30W	May 1995	24	24	24	24	24	24	24	24	24		FM13	Operational	Open Ocean Design A co-operative project between Météo France & the UK Met Office
62029	ODAS K1	48°43N 12°26W	Dec 1991	24	24	24	24	24	24	24	24	24		FM13	Operational	Open Ocean Design
62081	ODAS K2	51°02N 13°20W	Dec 1991	24	24	24	24	24	24	24	24	24		FM13	Operational	Open Ocean Design
62108	ODAS K3	53°35N 15°33W	Oct 1989	24	24	24	24	24	24	24	24	24		FM13	Operational	Open Ocean Design
62105	ODAS K4	55°29N 13°00W	Oct 1989	24	24	24	24	24	24	24	24	24		FM13	Operational	Open Ocean Design
64045	ODAS K5	59°15N 11°40W	July 1994	24	24	24	24	24	24	24	24	24		FM13	Operational	Open Ocean Design
62106	ODAS RARH	56°59N 09°53E	May 1994	24	24	24	24	24	24	24	24	24		FM13	Operational	Open Ocean Design
62100	ODAS K16	57°00N 00°00	July 1995	24	24	24	24	24	24	24	24	24		FM13	Operational	Open Ocean Design
62026	ODAS K17	55°20N 02°20E	July 1995	24	24	24	24	24	24	24	24	24		FM13	Operational	Open Ocean Design
62303	St Gowan	51°31N 04°56W	Sept 1994	24	24	24	24	24	24	24	24	24		FM13	Operational	Open Ocean Design

These numbers represent the number of observations per day

Table II-5 - Information on non-drifting ODAS

IDENTIFIER		LOCATION		VARIABLES MEASURED										COMMENTS		
WMO	OTHER	POSITION	DATE Deployed	Air Temp	Air Press	Press Tend	Humidity	Dew Point (Derived)	Wind (DD,FF)	Max Gust	Waves (SigHt,Period)	SST	Visibility	Code	Status	
62103	LV Channel	49°55N 02°53W	June 1989	24	24	24	24	24	24	24	24	24	24	FM13	Operational	Light Vessel
62305	LV Greenwich	50°25N 00°00W	May 1994	24	24	24	24	24	24	24	24	24	24	FM13	Operational	Light Vessel
62304	LV Sandetie	51°09N 01°49E	May 1993	24	24	24	24	24	24	24	24	24	24	FM13	Operational	Light Vessel
62107	LV Seven Stones	50°04N 06°04W	Nov 1994	24	24	24	24	24	24	24	24	24	24	FM13	Operational	Light Vessel
62129	AMOCO	53°03N 02°14E	1981	24	24	24	24	24	24		24			FM13	Operational	Platform
63111	Beryl'A'	59°33N 01°32E	1979	24	24	24	24	24	24		24			FM13	Operational	Platform
03007	Muckle Holm	60°35N 1°16W	1980	8		8	8	8	8					FM13	Operational	Island
03010	Sule Skerry	9°05N 04°24W	1981	24	24	24	24	24	24	24			24	FM12	Operational	Island
03011	North Rona	59°10N 05°50W	Aug 1990	24	24	24	24	24	24	24				FM12	Operational	Island
03695	Whitaker Beacon	51°40N 01°06E	1980	8	8	8	8	8	8					FM12	Operational	Tower
03014	Foula	60°07N 2°04W	June 1983	8	8	8	8	8	8					FM12	Operational	Island
62118	BPForties	57°45N 00°55E	Dec 1983	24	24	24	24	24	24					FM13	Operational	Platform
62165	Ravenspurn	54°02N 01°07E	Dec 1995	24	24	24	24	24	24		24			FM13	Operational	Platform
63103	North Cormorant	61°14N 01°09E	1984	24	24	24	24		24					FM13	Operational	Platform
62126	Morecambe Bay	58°51N 03°35W	1987	8	8	8	8		8					FM13	Operational	Platform
62112	Brac'A'	58°42N 01°17E	1987	24	24	24	24		24					FM13	Operational	Platform

These numbers represent the number of observations per day

UNITED STATES OF AMERICA

1. Introduction and historical overview

The United States of America () carries out or coordinates operation of two major moored buoy systems and one major ODAS program. One of the buoy programs and the ODAS programs have the primary purpose of supporting operational forecasting; the primary purpose of the other major buoy program is global climate monitoring.

The National Data Buoy Center (NDBC) operates and maintains the moored buoy and Coastal-Marine Automated Network (C-MAN) whose primary mission is to support operational forecasting of the National Weather Service (NWS). Established in 1970, NDBC began as the National Data Buoy Development Project (NDBDP). The NDBDP consolidated several moored buoy development efforts in the under one activity. Over several years, technology improvements and knowledge gained in automated system development, operations, maintenance, and data quality monitoring led to a dependable, very reliable system that was trted by forecasters. Becae of its expertise in ruggedized, automated marine monitoring systems, NDBC was assigned to develop C-MAN in the early 1980s. Becae manual weather observations were about to be lost from vario U.S. Coast Guard navigational aids that were becoming automated, C-MAN was needed to preserve the availability of weather observations. In addition to their importance to operational forecasting, the data records at many stations about to become automated were many decades long. To discontinue such a record would have been unfortunate. NDBC applied lessons learned in its moored buoy program to the fixed stations in C-MAN, including a diligent effort to identify the best possible instrument exposure to represent the marine environment.

Also in the mid 1980s, following an extreme El Niño, NOAA's Pacific Marine Environmental Laboratory (PMEL), which had been involved in development efforts for a low-cost, year long mooring, developed the first prototype Autonomo Temperature Line Acquisition System (ATLAS) thermistor chain moorings. Between 1985 and 1995, the Tropical Atmosphere Ocean (TAO) Array was expanded to 69 stations that stretches across the equatorial Pacific from 95°W to 135°E, between 10°N and 10°S. The primary purpose of the TAO Array was to provide real-time oceanographic and meteorological data for e in short-term climate studies. However, the data are also distributed over the GTS and are ed in operational numerical models for shorter term weather forecasting.

Between NDBC and PMEL alone, more than 200 moored buoys and C-MAN stations supply data to the GTS. There are several smaller moored buoy efforts involving U.S. agencies, including Scripps Institution of Oceanography (SIO), Woods Hole Oceanographic Institution, and others.

2. Moored buoys -

- (a) *NDBC* (more information available electronically on the World Wide Web at <http://seaboard@ndbc.noaa.gov>)
 - (i) **hull description** (Figure II-5) - disc or boat-shaped (see figure 1 for specifications). 12 m and 10 m hulls are steel; NOMAD hulls are aluminum; all others are aluminum or closed-cell ionomer foam.
 - (ii) **moorings** (see Figure 3 of the text for description of types)

ANNEX II - 37

- (iii) **power systems** - hybrid systems in which commercially available solar panels augment secondary batteries. Power control unit provides series regulation and power switching. Small capacity primary batteries provide power in case solar system fails.
 - (iv) **electronics payloads** - several generations of automated, self-timed systems in e that report via GOES. Newest operational payload, Value Engineered Environmental Payload (VEEP) requires 11 to 15 VDC power source. Software written in C language. Can be operated through POES.
 - (v) **sensors** - standard suite includes barometric pressure, wind, air and sea surface temperature, and non-directional waves.
 - **barometric pressure** - 800-1100 hPa range
 - **wind direction** - speed and 5-sec peak wind-propeller and vane instrument providing direction via a 10,000 ohm potentiometer and speed via frequency converter.
 - **air temperature** - commercially available thermistor mounted in a standard radiation shield.
 - **sea temperature** - identical thermistor, except attached to the hull interior below the water line and insulated from the interior hull environment. Th, sea temperature is measured from interior of the hull skin.
 - **waves**: non-directional wave spectra estimates from which significant wave height, dominant wave period, and average wave period are derived. The method es FFT methods of segmented overlapping data records as well as auto-correlations of discrete time records.
 - **directional wave systems**: Datawell Hippy^R sensor combined with a magnetometer to provide geographic orientation; a magnetometer combined with an accelerometer; or the wave processing module (WPM), which may be ed with any wave sensor system.
 - **currents** - 75 KHz Acotic Doppler Current Profilers installed in a well extending through the hull and facing the ocean bottom. Only on certain buoys.
 - (vi) **deployment procedures**
 - **preparation** - complete hull refurbishment, integration, assembly, and testing, ually at headquarters indtrial facility. System then broken down for shipment. "Mooring in a box" method simplifies deployment operations.
 - **type of ship** - U.S. Coast Guard vessels of opportunity, except buoy tenders required for certain operations. Three consecutive successful hours of ground truth before releasing ship from station location.
 - (vii) **special considerations** - data return is approximately 90%. Primary cae of lost data is system or sensor failures awaiting repair.
- (b) **PMEL** (more information available electronically over the World Wide Web at <http://www.pmel.noaa.gov/toga-tao/home.htm>)
- (i) **hull description** - 2.3 m toroid with 3.8 m tower. Hull constructed of polyurethane foam surrounded by fiberglass.

ANNEX II - 38

- (ii) **mooring** - combination of taut (500 m) wire rope at surface, and nylon line lower mooring connected to a 2000 kg anchor by an acotic release.
 - (iii) **power systems** - batteries
 - (iv) **electronic payload** - data logger/transmitter stores and transmits data via Service Argos. Transmitted data are routed to the GTS for distribution to analysis and forecast centers. Transmissions occur during two 4-hour windows daily. Each transmission includes the most recent hourly data and previo daily averaged data. A final data set is submitted to U.S. Archive Centers and TOGA Data Center after recovery and recalibration of all sensors.
 - (v) **sensors** - ATLAS buoy standard suite includes surface winds, air and sea surface temperature, relative humidity, 10 sub-surface temperatures to 500 m, and water pressure at 2 depths.
 - **wind direction and speed**: sampled at 2Hz for 6 min centered at the top of the hour and vector averaged. Anemometer height is 4 m.
 - **air temperature**: sampled every 10 min at 3 m with resolution of 0.04°C and accuracy better than 0.5°C; averaged at the top of each hour.
 - **sea temperatures**: surface and sub-surface measured to a resolution of 0.002°C and accuracy better than 0.1°C at 1 m and at 10 depths from 20m to 500 m. Thermistors are mounted on a polyurethane-jacketed double-armor three conductor cable.
 - **water pressure**: at 2 depths between the surface and 500 meters to monitor vertical excursions of the cable.
 - **relative humidity**: measured at 3 m, for 10-min, averaged 6 times each hour, then averaged at the top of the hour.
 - (vi) **deployment procedures** - sensors are calibrated both prior to deployment and after recovery to estimate sensor accuracy and drift. Each station is visited annually. Due to the large size and geographic extent of the array, nearly one year of dedicated ship time is required to maintain the full array.
 - (vii) **special considerations** - data return is greater than 80 percent; greatest cae for loss is due to damage to moorings in the far eastern and western Pacific where fishing activity predominates.
- (c) **SIO**
- (i) **Hull description** - Datawell directional and non-directional
 - shape - round
 - size - 1 meter
 - weight - 450 lbs
 - material - stainless steel
 - (ii) **Moorings**:
 - Type** - combination of polypropelene line, Datawell elastic cord, and wire cable.
 - Design** - surface following elastic mooring, 2 to 1 scope.
 - Depths** - 30 to 250 metre, depending on location
 - Anchors** - 1200 lbs chain strapped to a pallet
 - (iii) **Power systems** Batteries - 1.5 volt carbon zinc cells
 - (iv) **Electronics payload**: Microprocessor: Datawell
Transmitter: Datawell FM & FSK at 29.8 mhz

ANNEX II - 39

(v) **Sensors:**

Description: directional buoy: wave height, period, direction and sea surface temperature

Characteristics: Sample rate = 1.3 sec

Record lengths processed = 1600 sec (directional)
2048 (non-directional)

(vi) **Deployment procedures:**

Preparation: calibration, batteries, etc.

Type of ship: coast guard, fishing vessel, or research ship. Also, helicopter installations.

Mooring deployment - deploy buoy first, pay out mooring, then drop anchor.

Length of time - one and a half year - two years

(vii) **Special considerations:** Reason for data loss - collision damages buoy or mooring, battery changeout, electronics, vandalism.

(viii) **Refurbishment:** Paint - 2 component urethane with anti-fouling.

(ix) **Stations:** Between 1 - 20 miles offshore

3. Other ODAS

- (a) *Coastal-Marine Automated Network (C-MAN)* - stations installed on light hoists, towers, and piers.
- (b) *exposure* - optimized as much as possible to represent the marine environment.
 - sensors on Rohn towers or trolley masts usually at 10 m (winds)
 - sensors on light hoists vary to optimize exposure
- (c) *special considerations* - access depends on the location, varies from easy (e.g., a public fishing pier) to remote (e.g. small uninhabited island). Vandalism is occasionally a problem.
- (d) *electronics* - match NDBC moored buoy systems.
- (e) *sensors* - standard suite of sensors includes barometric pressure; wind direction, speed, and gust; and air temperature. Some stations also have sea surface temperature and/or sea state. Sampling strategy matches moored buoys, except wind average is only 2-min.

4. Data management

(a) *Data flow*

- (i) **NDBC** - usually hourly via GOES over pre-assigned communications channels. Data received at the ground station at Wallops Island, VA, and immediately routed to the NWS Telecommunications Gateway for processing, initial data quality checks, and distribution via GTS. Some data sent via POES and Service Argos system, mainly from land stations in Micronesia. Also, controlled direct access via land-line or cellular phone to some C-MAN stations to obtain more

ANNEX II - 40

frequent observations at individual offices. Line-of-sight (LOS) system used on special projects.

(ii) **PMEL** - via Service Argos to GTS and on-board recording retrieved annually.

(b) **Quality control**

(i) **NDBC** - three stages; 1) real-time prior to release over GTS to detect gross errors; 2) within 24 hours for subtle data errors; 3) monthly prior to submission to U.S. Archive Centers to ensure accuracy, including metadata.

(ii) **PMEL** - pre- and post-calibration of sensors to determine sensor drift and application of necessary corrections to archived data set.

(iii) **Data management:**

Communication routes:- VHF antenna to shore station. Shore station to Scripps (via phone line) for in-hoe processing.

- Argos ADS

Dissemination: NWS - AFOS // Internet/Web page/FTP // Dial-in telephone lines // Monthly/Annual reports

Archiving: All time series and condensed spectra are stored on disk and 4mm dat.

MOORED BUOY HULL CHARACTERISTICS

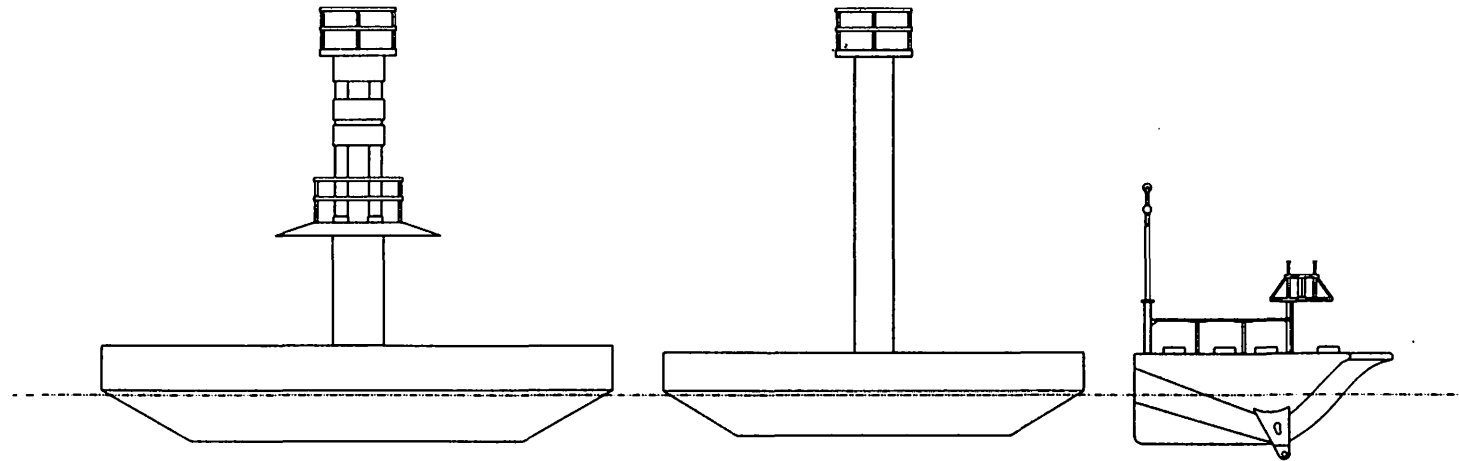

12-METER DISCUS

Weight 87,500 kg
 Diameter 12.2 m
 Draft 1.10 m
 Freebd 1.19 m

10-METER DISCUS

Weight 52,400 kg
 Diameter 10.1 m
 Draft 0.97 m
 Freebd 1.01 m

6-METER NOMAD

Weight 6,300 kg
 Length 6.1 m
 Draft 1.49 m
 Freebd 0.64 m

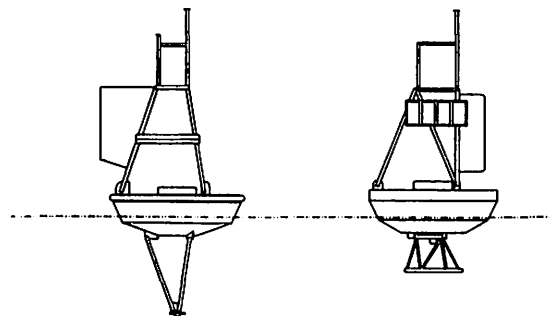

3-METER DISCUS

Weight 1,720 kg
 Diameter 3.0 m
 Draft 0.46 m
 Freebd 0.51 m

3-METER VE DISCUS

Weight 1,540 kg
 Diameter 3.0 m
 Draft 0.39 m
 Freebd 0.62 m

Figure II-6

ANNEX III

LIST OF ACRONYMS

ADCP	Acoustic Doppler Current Profiler
ATLAS	Autonomous Temperature Line Acquisition System
AtoN	Aid-to-Navigation
C-MAN	Coastal-Marine Automated Network
CMM	Commission for Marine Meteorology (of WMO)
DACS	Data Acquisition and Control System
DBCP	Data Buoy Cooperation Panel
DC	Direct current
DCP	Data Collection Platforms
FAA	Federal Aviation Administration
FGGE	First GARP Global Experiment
FSP	Field Service Plan
GMS	Geostationary Meteorological Satellite (Japan)
GOES	Geostationary Operational Environmental Satellite (US)
GPS	Global Positioning System
GTS	Global Telecommunication System (of the WWW of WMO)
HF	High frequency
hPa	hectopascal
IALA	International Association of Lighthouse Authorities
IGOSS	Integrated Global Ocean Services System (of IOC and WMO)
ILHA	Icelandic Lighthouse and Harbour Authority
INPE	National Institute for Space Research (Brazil)
IOC	Intergovernmental Oceanographic Commission
JMA	Japan Meteorological Agency
KNMI	Royal Netherlands Meteorological Institute
LORAN	Long-range Navigation
LUT	Local User Terminal
MAREP	Marine Reporting Program
MARS	Multifunction Acquisition and Reporting System
MO	Magnetometer only
MSC	Meteorological Satellite Centre (Japan)
NASA	National Aeronautics and Space Administration
NCEP	National Center for Environmental Prediction
NDBC	National Data Buoy Center (of NOAA, US)
NDBDP	National Data Buoy Development Project
NOAA	National Oceanic and Atmospheric Administration
NOMD	Navy Oceanographic and Meteorological Automatic Device (US)
NWS	National Weather Service (of NOAA, US)

ANNEX III-2

NWSTG	NWS Telecommunications Gateway
ODAS	Ocean Data Acquisition Systems
ONR	Office of Naval Research (US)
PMEL	Pacific Marine Environmental Laboratory (US)
PMOC	Principal Meteorological or Oceanographic Center
POES	Polar-orbiting Operational Environmental Satellite
PROANTAR	National Program for Antarctic Research
PSK	Phase Shift Keying
SIO	Scripps Institution of Oceanography (US)
SVP-B	Surface Velocity Profiler with Barometer
TAO	Tropical Atmosphere Ocean
TOGA	Tropical Ocean and Global Atmosphere (of the WCRP)
T _z	Subsurface temperature measurements
UHF	Ultra High Frequency
UK	United Kingdom
UKMO	United Kingdom Meteorological Office
US	United States of America
VACM	Vector Averaging Current Meter
VEEP	Value Engineered Environmental Payload
VMCM	Vector Measuring Current Meter
W	Watt
WCRP	World Climate Research Programme (of WMO and ICSU)
WHOI	Woods Hole Oceanographic Institute (US)
WOCE	World Ocean Circulation Experiment
WSD	Wind Speed and Direction
WMO	World Meteorological Organization
WOTAN	Wind Observation through Ambient Noise
WWW	World Weather Watch (of WMO)

TECHNICAL DOCUMENTS ISSUED WITHIN THE DATA BUOY CO-OPERATION PANEL SERIES

No.	Title	Year of issue
1	Annual report for 1994	1995
2	Reference Guide to the GTS Sub-system of the Argos Processing System	1995
3	Guide to Data Collection and Location Services using Service Argos	1995
4	WOCE Surface Velocity Programme Barometer Drifter Construction Manual	1995
5	Surface Velocity Programme (SVP) - DBCP/SIO Workshop on SVP barometer drifter evaluation	1996
6	Annual report of the DBCP for 1995	1996
7	Developments in buoy technology and enabling methods - Technical presentations made at the eleventh session of the DBCP	1996
8	Guide to moored buoys and other ocean data acquisition systems	1997

These publications can be ordered from: Etienne Charpentier, Technical Co-ordinator of the DBCP, CLS/Service Argos, 18, Av. E. Belin, 31055 Toulouse Cédex, FRANCE - Email charpentier@atlas.cnrs.fr fax +33 61 751 014

